



A1040 MIRA 3D

Ultrasonic low-frequency tomograph

Operation manual

Revision 1.1.0

Acoustic Control Systems - ACS Group
Saarbrücken, Germany 2021



7952 Nieman Road, Lenexa, KS 66214-1560 USA
Phone: 913-685-0675, Fax: 913-685-1125
www.ndtsupply.com, sales@ndtsupply.com

This instruction manual contains essential information on how to use this ACS product safely and effectively. Before using this product, thoroughly review this instruction manual. Use the product as instructed.

1. Cover Page Back	4
2. Cover Page Front	5
3. Important basic information	6
4. Abbreviations	8
5. Lables, position and content	9
6. Scope of Delivery	11
6.1 A1040 MIRA 3D	11
6.2 A1040 MIRA 3D PRO	12
7. Main Components	16
8. Keys and system LEDs	19
9. Rechagreable Battery of the Main Device	22
10. Rechargeable Battery of the Control Unit	25
11. Device usage and Limitations	29
12. Safety	32
13. Maintenance and Repair	34
14. Technical Specification	37
15. Operation	38
16. Trouble shooting	42
17. CE Certificate	46
18. B-Scan	47
18.1 Main parameters	47
18.2 Display parameters	48
18.3 File manager	50
19. MAP	54
19.1 Main parameters	54
19.2 Display parameters	55
19.3 File manager	55

19.4	MAP manager	55
20.	C-Det	57
21.	A-Scan	59
21.1	Farm View: A1048 MIRA 3D	61
21.2	Farm View: A1048 MIRA 3D PRO	64
22.	Reporting	65
23.	Setup	68
23.1	Instrument configuration	71
23.1.1	A1040 MIRA 3D	71
23.1.2	A1040 MIRA 3D PRO	73
23.2	Automatic transducer testing	75
23.2.1	A1040 MIRA 3D	75
23.2.2	A1040 MIRA 3D PRO	77
24.	Powering	79
25.	Connectivity	82
25.1	WiFi Hotspot	82
26.	Getting started	85
26.1	App installation	85
26.2	App activation	86
26.3	Preparation for work	88
26.4	Update	89
27.	Licensing	92
28.	File format	95
28.1	File list	95
28.2	Modes	98
Index		0

1 Cover Page Back



Service Address: ACS-Solutions GmbH
Science Park 2
66123 Saarbrücken
Germany
Phone: +49 (0) 681 9659 2270
Fax: 49 (0) 681 9659 2280
E-Mail: info@acs-international.com
Web: acs-international.com

2 Cover Page Front

A1040 Mira 3D

ULTRASONIC LOW-FREQUENCY TOMOGRAPH

User Manual



This manual contains important information about the correct and safe use of the device.

Read this manual carefully before using the device for the first time and use the device only in the intended manner.

Always keep this manual in the vicinity of the device.

Revision: 1

Issued: November, 18 th 2020



CAUTION

Make sure the manual on hand corresponds with the currently installed firmware and control software release on your system.

Check the firmware and control software release that is currently installed on your system (for further information see chapter "[Setup](#)")^[88]

With every firmware and control software update the functionality of the device will change. It is possible that formerly described functions are not available any more, new functions are added or pictograms and/or procedures change. These changes will be documented in the latest, online available manual.

Check [page](#)^[89] for available manuals and software updates.

3 Important basic information

Read this manual carefully before using the device to ensure safe and proper use.

Intended use:

The A1040 MIRA3D device is intended for the ultrasonic inspection of constructions made of concrete, reinforced concrete and stone with one-sided access. The design is for manual operation. For positioning purposes, the device is equipped with 4 positioning Laser-LEDs class 2M.



WARNING

Never Use the device for any other purposes than stated above. Never use the device on humans or animals. Never look into the Lasers. For further Safety instructions see chapter Safety

The A1040 MIRA3D device must be connected via hotspot to a Control Unit. Only use Control Units approved by ACS for this purposes.



CAUTION

A1040 Mira 3D is normally equipped with a tablet device as Control Unit that is seated in a specially developed housing. The Control Units provided by ACS are selected to guarantee a save and reliable operation of the all over system. Please do not try to open the provided Housing for the control unit. If the control Unit is damaged or malfunctioning, please contact your ACS support.



WARNING

Do not try to control the A1040 Mira 3D with other mobile devices that are not specified and provided by ACS, even if the connectivity and capability of executing the control software seems given. This may result in unexpected behavior, personal injury, and / or equipment damage including impairment of safety. ACS is not liable for any damage or loss (whether contractually or unauthorized, including negligence) caused by not following this warning.

This A1040 Mira 3D is CE-certified according to 2014/30/EU (EMC).



Liquid ingress protection and solid particle protection of the casing is in conformity with level IP53 (standard EN 60529), so the equipment is splash proof and protected against dust.

Despite the IP classification, it is possible that the device will be damaged in certain situations.

Follow the instructions below to maintain water resistance and dust protection.

- Never immerse the equipment into water.
- After contact with clear water, wipe it thoroughly with a clean soft cloth.
- Contact of the device with liquids other than water may adversely affect the performance and appearance of the device.
- Dropping the device may affect the device protection.
- The device should never be opened by untrained personnel.

Safety symbols used in this Manual:

Symbol	Description
 WARNING	Indicates a potential threat. Failure to avoid it can result in death or serious injury.
 CAUTION	Indicates a potential threat. Failure to avoid it may result in minor injury.
IMPORTANT	Indicates a potentially harmful situation. If it is not avoided, the device or something in its vicinity may be damaged.





4 Abbreviations

Geben Sie hier den Text ein.

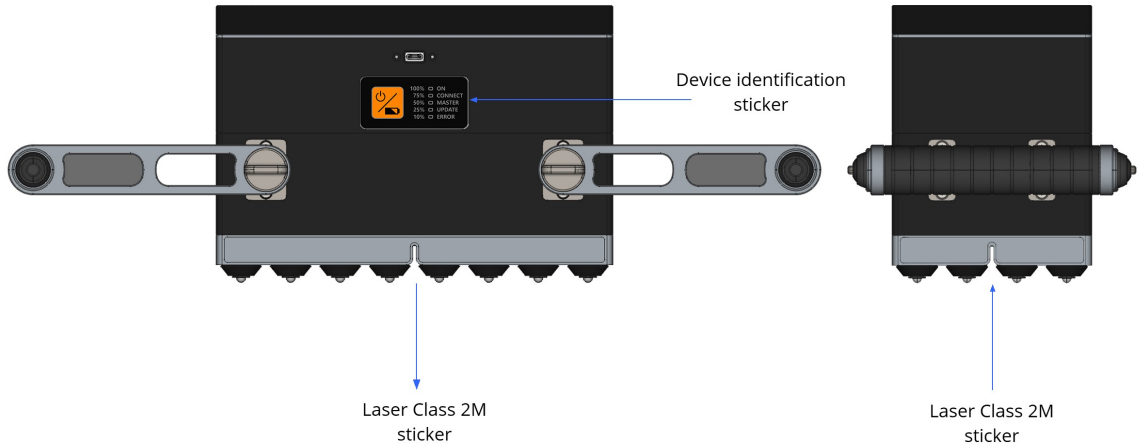
5 Lables, position and content

Labels are safety related and must be present at all time when the device is in use.
Labels are positioned according the Figures ?? below.



Description	Content
device identification Sticker	 <p>Device Name: A1040 MIRA 3D</p> <p>Manufacturer: Acoustic Control Systems-ACS Group</p> <p>Manufacturer Homepage Address: ACS-Interantiona.com</p> <p>Country of origin: Made in Germany</p> <p>CE: Conformity declaration for applicable European Directives</p> <p>FCC: Conformity declaration for requirements of the Federal Communications Commission (FCC) -relevant for delivery, sales and import to USA.</p> <p> Sign or "Read manual first"</p> <p> WEEE symbol that the product contains batteries. These must be collected and disposed of separately according the regional laws.</p> <p>S/N: Serial number of the Device beginning with 120 followed by 5 digits.</p>
Laser class 2 M	 <p>Warning sign placed on the exiting points of all 4 Laser-Diodes. Please see chapter "Safety" for further Detail</p>

6 Scope of Delivery

The following two sections describe the scope of delivery and assembly instructions for A1040 MIRA 3D and A1040 MIRA 3D PRO.

6.1 A1040 MIRA 3D

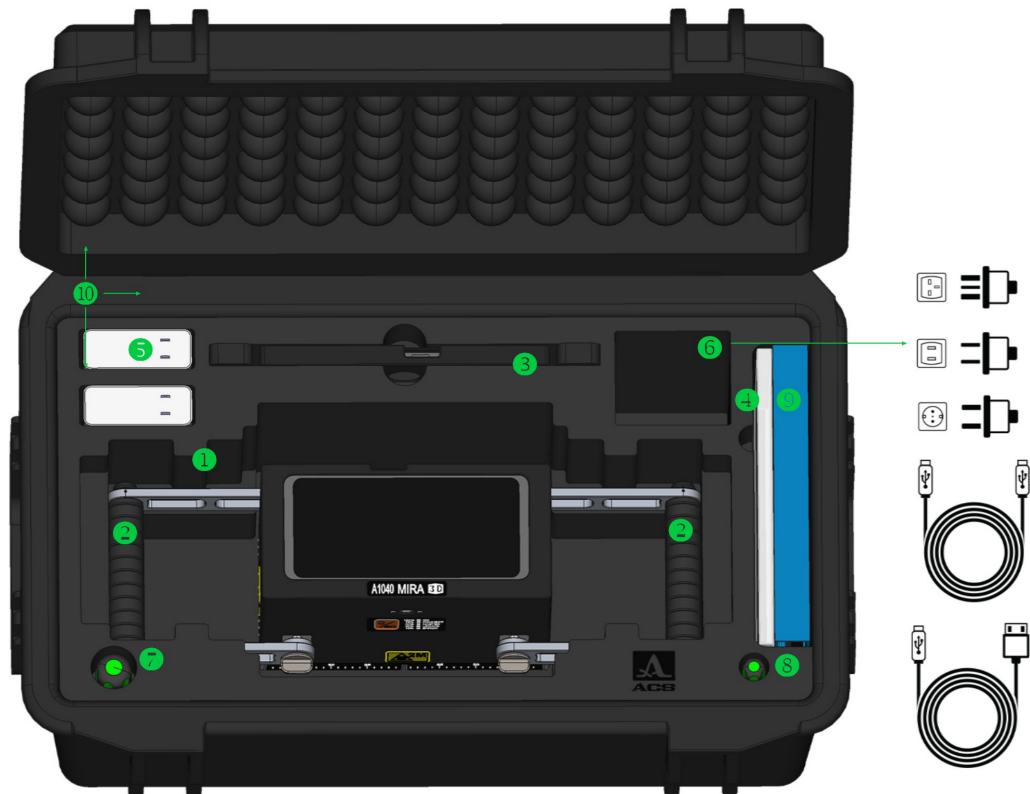

A1040 MIRA 3D Scope of delivery

Part	Amount	Location
Electronic unit A1040 MIRA 3D with 32 x A-DPC® transducers	1	①
Adjustable handle	2	②
Tablet-PC with protective case	1	③
Reference block for functional tests	1	④
Exchangeable Li-Ion accumulator	6	inside of the electronic unit
Power charger	1	⑤
Interchangeable power plugs (US/UK/EU)	3	in the pocket ⑥, 2xUS, 2xUK and 2xEU
Power USB-C cable	1	in the pocket ⑥
USB-A to USB-C cable	1	in the pocket ⑥

Screwdriver Hex-Plus 4.0	1	7
Screwdriver Hex-Plus 2.0	1	8
Cardboard box for documentation	1	9
Warranty certificate	1	inside of cardboard
Operating Manual	1	inside case 10
Hard case with custom foam inlay	1	10

6.2 A1040 MIRA 3D PRO

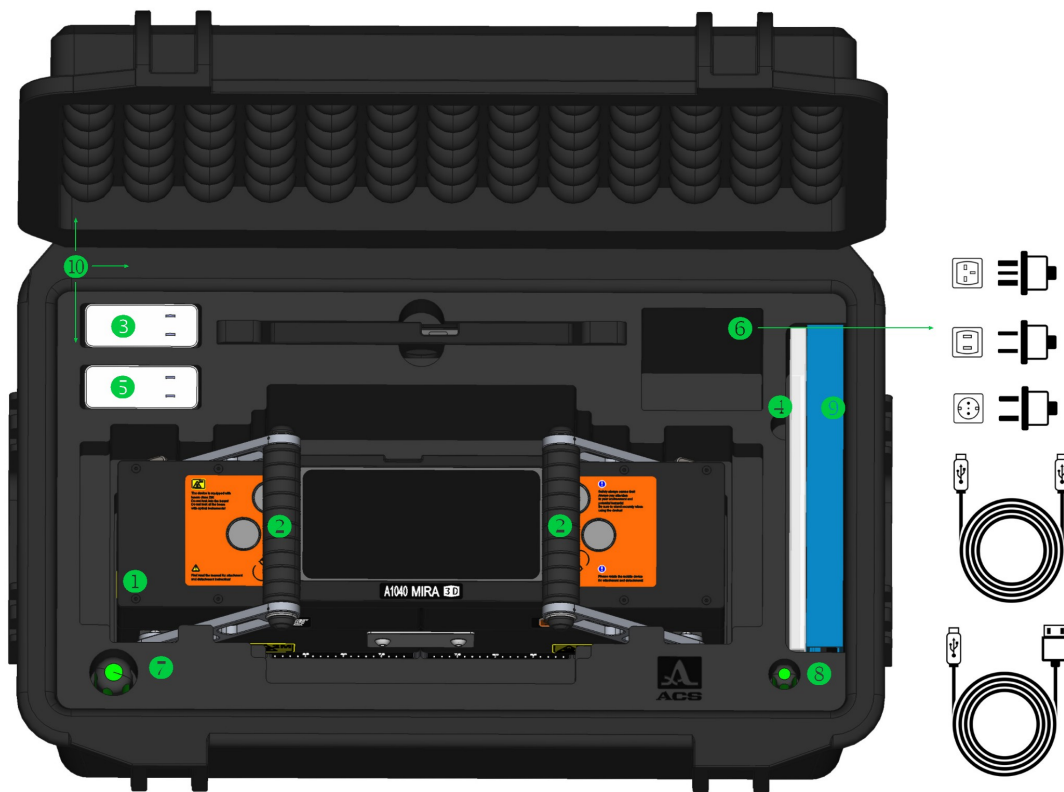

Figure 1: Scope of delivery

A1040 MIRA 3D PRO Scope of delivery

Part	Amount	Location
Electronic unit A1040 MIRA 3D with 32 x A-DPC® transducers	2	1
Adjustable handle	2	2
Tablet-PC with protective case	1	3

Reference block for functional tests	1	④
Exchangeable Li-Ion accumulator	12	inside the electronic unit
Power charger	2	⑤
Interchangeable power plugs (US/UK/EU)	6	inside the pocket ⑥, 2xUS, 2xUK and 2xEU
Power USB-C cable	2	inside the pocket ⑥
USB-A to USB-C cable	1	inside the pocket ⑥
Screwdriver Hex-Plus 4.0	1	⑦
Screwdriver Hex-Plus 2.0	1	⑧
Cardboard box for documentation	1	⑨
Warranty certificate	1	inside the cardboard box ⑨
Operating Manual	1	inside the case ⑩
H-Fastener	2	refer to ② on Figure 3
A2 M6x10 stainless screw	4	refer to ① on Figure 3
Hard case with foam inlay	1	⑩

Electronic units

The A1040 MIRA 3D PRO has two electronic units. These are the master M (also called *primary unit*) and the slave S (also called a *secondary unit*). The serial number of the master is less than then the serial number of the slave. Use the master and slave according to the licensing [policy](#)⁹².

Assemble the A1040 MIRA 3D PRO

The A1040 MIRA 3D PRO tomograph leaves the factory fully assembled. Follow up the given procedure to prepare a master to work as a stand-alone tomograph.

- Put the A1040 MIRA 3D PRO on the flat stable surface. The transducers lay on the surface.
- Detach the Tablet-PC
- Unscrew four screws ① on the both sides of the tomograph, use the screwdriver Hex-Plus 4.0 for unscrewing.

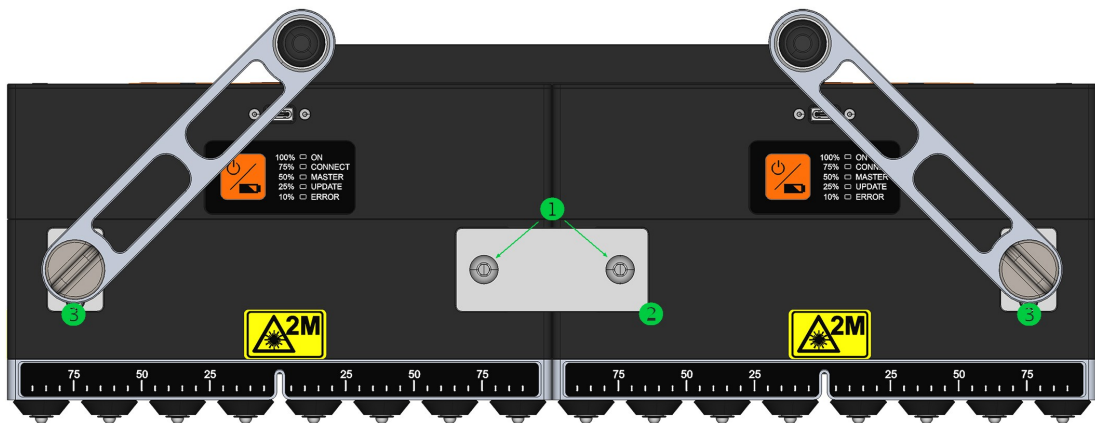
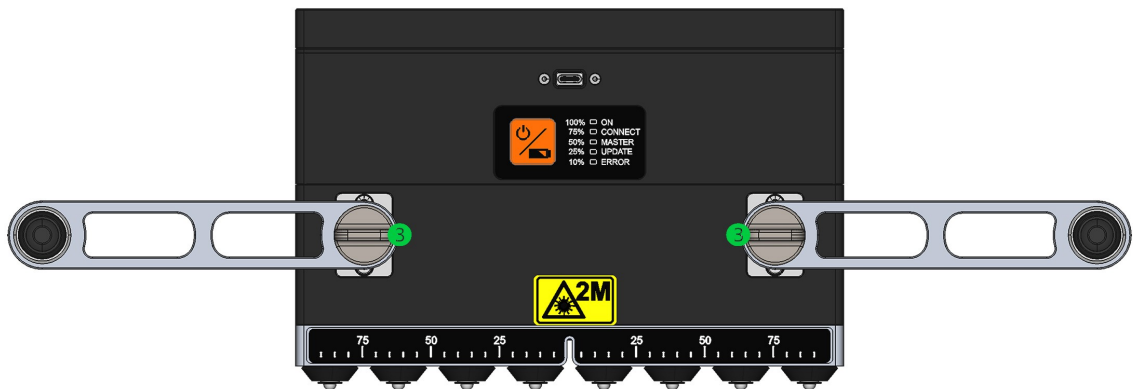

Figure 2: Assembly

- Dismount two h-fasteners **2**. Pus the screws and fasteners into the case pocket.
- Unscrew four handle bolts **3** on both sides of the tomograph
- Detach the handles from the secondary unit.
- Put the secondary unit in to the case
- Attach the handles to the primary unit



- Fasten the bolts **3** on

NOTE

Assemble the A1040 MIRA 3D PRO in the reverse order.



WARNING

Remove and mount the handles very carefully. Avoid deformation of the handle elements and housing damaging.

7 Main Components

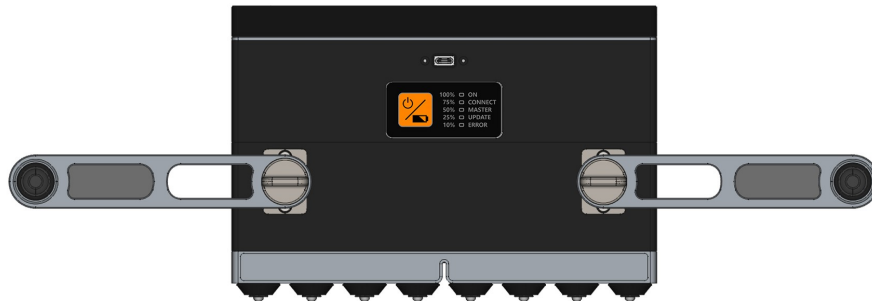

Main device

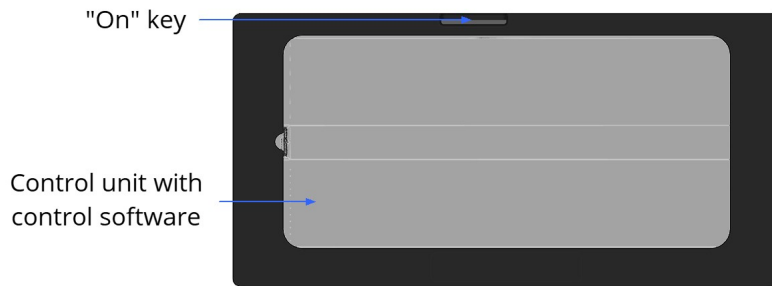

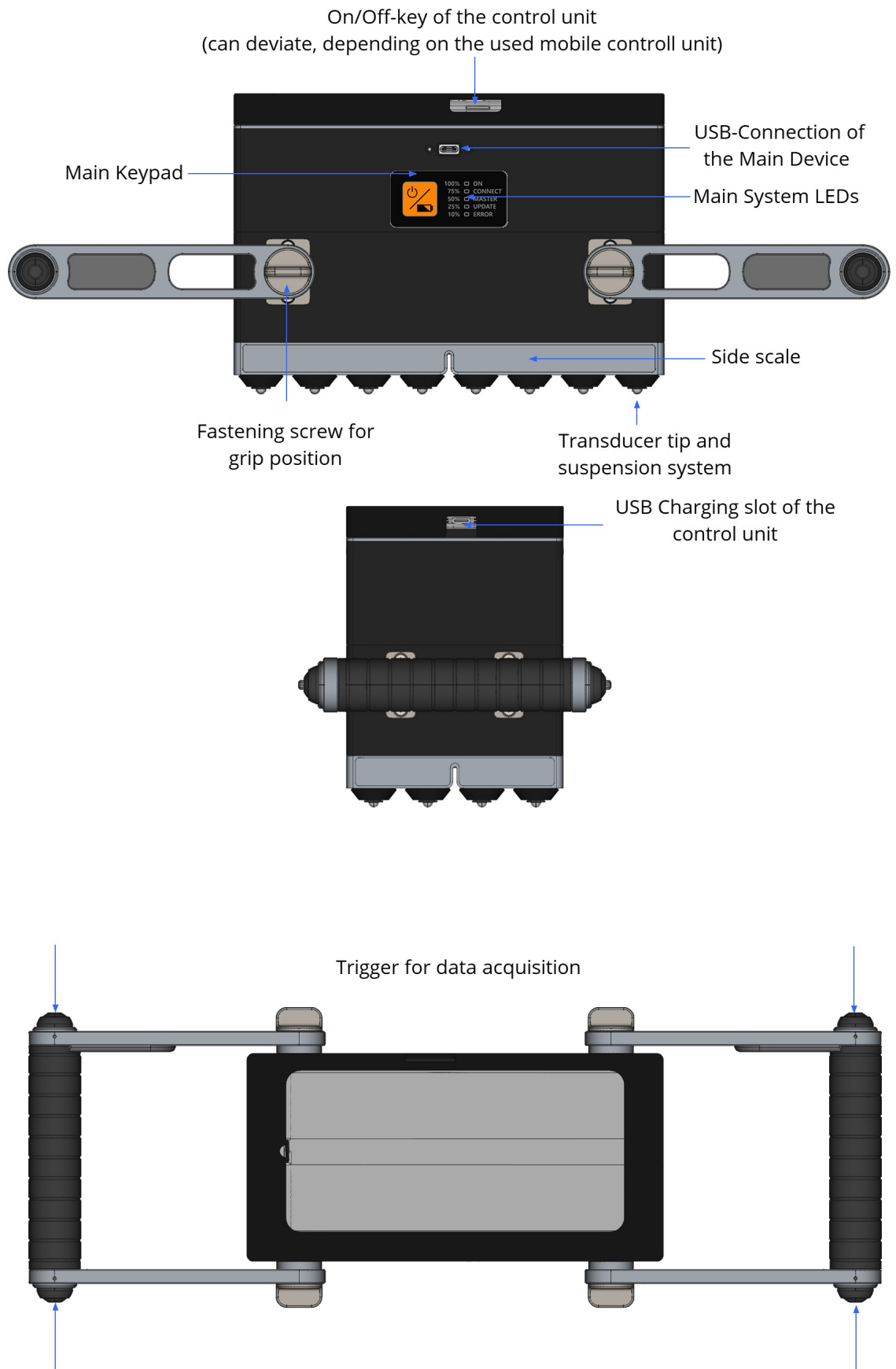

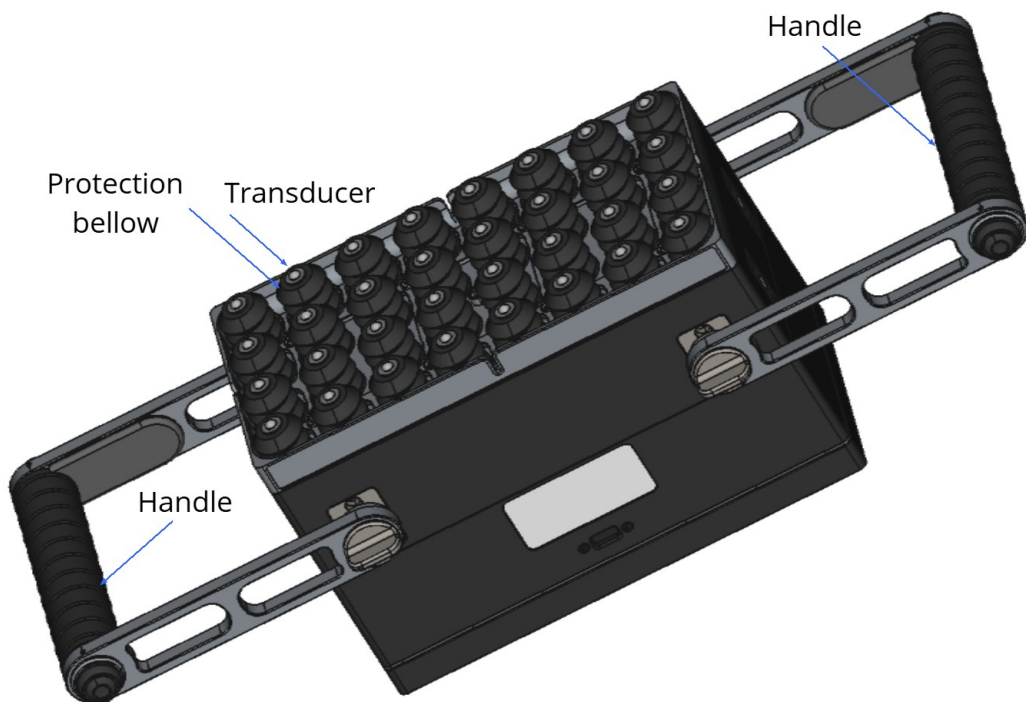
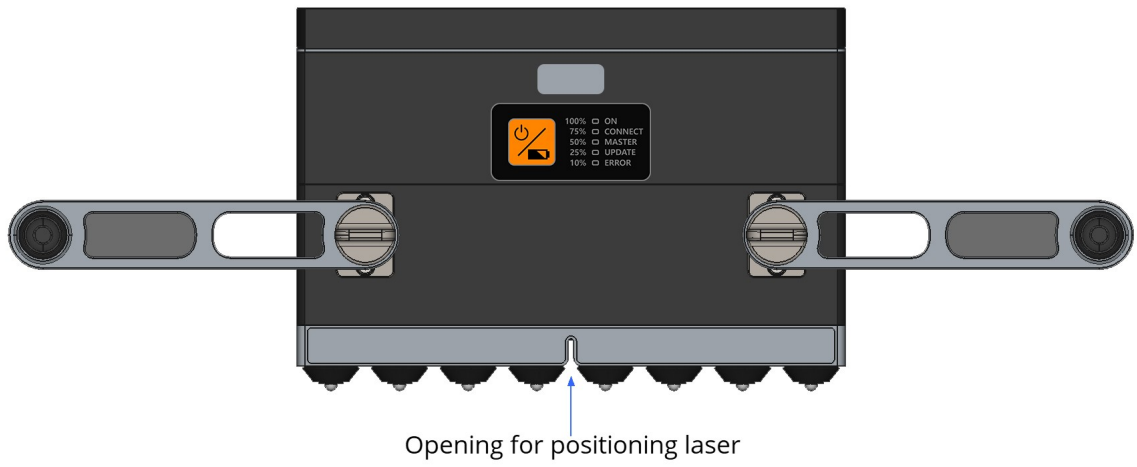

8 Keys and system LEDs

The A1040 Mira 3D Has two key -Types

Type One is the key for the operational preparation of the system and to run status checks. This KEY is found on the Main Keypad

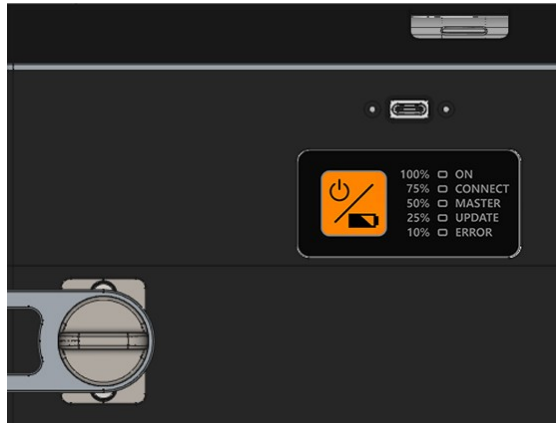

Figure 3: Keypad position

The Keypad has three basic functionalities. Switching the device on/off and start the battery charging status. Detailed Information is given in the table below.

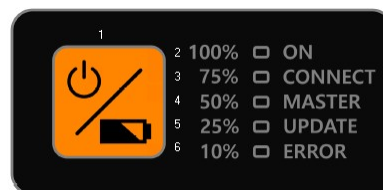
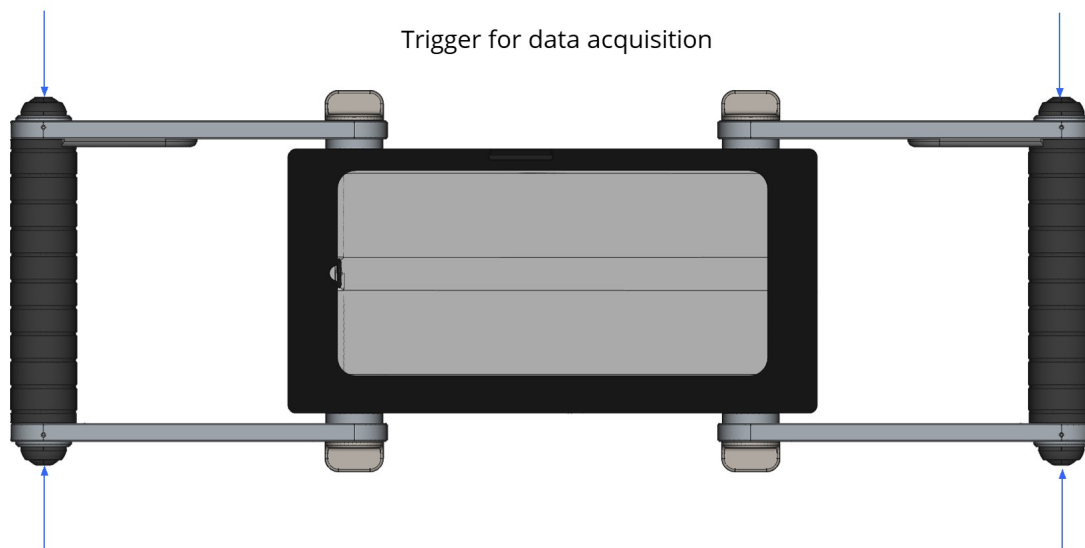

Figure 4: Keypad with LEDs

Key name	Functions
Power Key [1]	Press and hold the POWER Key for 3 seconds to activate the device
Power Key [1]	Press and release the POWER Key for the checking the battery status
Power Key [1]	Press and hold the POWER Key for 3 seconds to deactivate the device
Power Key [1]	Update procedure initiation (see chapter system update)

Type two is are the four trigger keys for the start of the acquisition during the system operation.



Key name	Functions
Trigger Key [2]	Data acquisition
Trigger Key [2]	Update initiation function when using WIFI as access point

The system LEDs have two basic functionalities, displaying the procedure mode and the charging status.

Normal operation mode

LED Name	Functions/Meaning
ON [2]	<p>Not lit when device is turned off</p> <p>Flashing green during hardware initialization and booting</p> <p>Constant green glow when the device is ready for operation</p>
CONNECT [3]	<p>Not lit when device is turned off</p> <p>Flashing green with 1 Hz frequency until a connection is established with the access point of the control device.</p> <p>Flashing green with 2 Hz frequency until the connection with the control program is established.</p> <p>Constant green glow when the Main Device is connected to the control program and ready for operation</p>

MASTER [4]	<p>Not lit:</p> <p>Option 1: The main device is not connected to the control program.</p> <p>Option 2: The main device is acting as slave in combination 4x16 or 8x8 with another device.</p> <p>Constant orange glow when the device is connected as Master to the control program.</p>
UPDATE [5]	<p>Not lit when device is in normal operation mode.</p> <p>Constant orange glow when the Main Device is connected to a PC and ready for receiving the update files. See chapter Update at page 89</p> <p>Flashing orange with 2 Hz frequency during the data transfer process.</p>
Error [6]	This LED has no functionality at the moment.

Checking the battery status mode. The LEDs are glowing constantly for a few seconds according the charging status and then switch off. The main device will stay switched off.

100 % [2]	green 100 % battery charging
75% [3]	green 75 % battery charging
50% [4]	orange 50 % battery charging
25% [5]	orange 25 % battery charging
10% [6]	red 10 % battery charging *
* at 10 % battery charging. the device should be recharged.	

9 Rechargeable Battery of the Main Device

**WARNING**

The rechargeable batteries of the Main Device shall not to be replaced by the operator, only by full trained personnel that has been authorized by ACS. For safety reasons, do not attempt to remove or replace the battery.

Incorrect removal or replacement of the battery may result in damage to the battery and the device, personal injury, and / or equipment damage including impairment of safety.

ACS is not liable for any damage or loss (whether contractually or unauthorized, including negligence) caused by not following this warning.

NOTE

Before first use, the rechargeable batteries must completely be charged.

If the instrument is not used for a period longer than three month, check charging status by press ON key short. When the charge has dropped to 25 %, recharge the device.

Make sure that the accumulator is completely charged once in two months, to prevent total discharge.

In that case of total discharge, the rechargeable batteries may be destroyed and must be replaced.

**WARNING**

Use only ACS - approved chargers and cables. Unauthorized chargers or cables may cause the batteries to explode or damage the device.

ACS is not liable for any damage or loss (whether contractually or unauthorized, including negligence) caused by not following this warning.

**WARNING**

Incorrect connection of the charger may cause serious damage to the device. Damage caused by improper use is not covered by the warranty.

Charging of the rechargeable battery

1. Connect one end of the USB-C cable to the USB-C power supply, and the other end to the USB-Connection of the Main Device



2. Connect the USB power supply to the mains socket.
3. When the charging process begins, the LED corresponding with the charging level will start to blink and glow constantly. When the status is reached the LED glows constantly and the LED for the next level will start to blink. .When the battery is charged 100 %, the 100 % LED is glowing constantly and the charging process is switching to trickle charge.

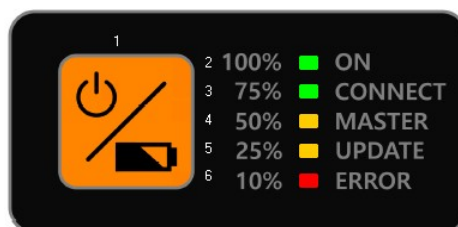

4. Separate the charging unit from the device, as the rechargeable battery has completely been charged.
5. First disconnect the charger from the device and then from the mains socket.

NOTETips and precautions for charging the battery

- In normal mode the device switches OFF as soon as the level drops beyond a certain safety limit. It is recommended not to restart the device before the charging procedure is complete to avoid damage.
- When the battery is discharged, the device will not turn on immediately after it has been connected to the charger. Charge the battery for a few minutes before turning the device back on.
- If the device is not charged through the USB power supply, but for example via a computer, this may result in a reduced charging speed due to a limited electrical power supply
- You cannot use the device while it is being charged.
- A moderate increase of temperature during charging procedure is not critical. In the case of a drastic temperature rise on the other hand, the charging unit must be removed at once.
- The charger does not have an on / off switch. So, you need to disconnect the charger from the power socket when not in use to prevent wasting energy.
- It is advisable to install the charging unit close to the mains connection and to keep the surroundings free, so that easy access is possible anytime.

10 Rechargeable Battery of the Control Unit

Rechargeable Battery of the Control Unit



CAUTION

A1040 Mira 3D is normally equipped with a tablet device as Control Unit that is seated in a specially developed housing. The Control Units provided by ACS are selected to guarantee a save and reliable operation of the all over system. The housing provides an opening for charging the control unit via the USB-C.

Please do not try to open the provided housing for the control unit. If the control Unit is damaged or malfunctioning, please contact your ACS support.

**WARNING**

Do not try to control the A1040 Mira 3D with other mobile devices that are not specified and provided by ACS, even if the connectivity and capability of executing the control software is given. This may result in unexpected behavior, personal injury, and / or equipment damage including impairment of safety. ACS is not liable for any damage or loss (whether contractually or unauthorized, including negligence) caused by not following this warning.

**WARNING**

Use only ACS - approved chargers and cables. Unauthorized chargers or cables may cause the batteries to explode or damage the device.

ACS is not liable for any damage or loss (whether contractually or unauthorized, including negligence) caused by not following this warning.

**WARNING**

Incorrect connection of the charger may cause serious damage to the device. Damage caused by improper use is not covered by the warranty.

Charging of the Control Unit

1. Connect one end of the USB-C cable to the USB-C power supply, and the other end to the USB-Connection of the Control Unit

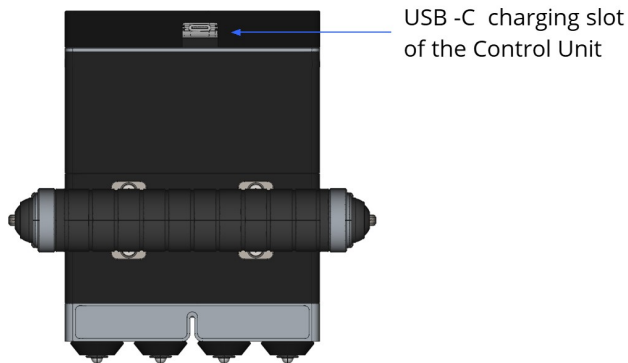

2. Connect the USB power supply to the mains socket.
3. When the charging process begins, the display of the Control Unit states, that the device is charging. When the device is fully charged, the percentage value next to the battery symbol shows 100 %. When the battery is charged 100 %, the charging process is switching to trickle charge.
4. Separate the charging unit from the device, as the rechargeable battery has completely been charged.
5. First disconnect the charger from the device and then from the mains socket.



WARNING

Charge mobile control only with dedicated cable. For more information refer [page 11](#).

NOTE

Tips and precautions for charging the battery

- In normal mode the device switches OFF as soon as the level drops beyond a certain safety limit. It is recommended not to restart the device before the charging procedure is complete to avoid damage.
- When the battery is discharged, the device will not turn on immediately after it has been connected to the charger. Charge the battery for a few minutes before turning the device back on.

- If the device is not charged through the USB power supply, but for example via a computer, this may result in a reduced charging speed due to a limited electrical power supply
- You cannot use the device while it is being charged.
- A moderate increase of temperature during charging procedure is not critical. In the case of a drastic temperature rise on the other hand, the charging unit must be removed at once.
- The charger does not have an on / off switch. So, you need to disconnect the charger from the power socket when not in use to prevent wasting energy.
- It is advisable to install the charging unit close to the mains connection and to keep the surroundings free, so that easy access is possible anytime.

11 Device usage and Limitations

**WARNING**

This section contains safety-relevant information and defines minimum requirements for user groups. Use of the device outside the intended use and by unintended user groups may result in damage.

Intended use

The A1040 MIRA3D device is intended for the ultrasonic inspection of constructions made of concrete, reinforced concrete and stone with one-sided access. The design is for manual operation.

**WARNING**

The A1040 shall only be used in controlled areas with no explosive atmosphere.

User groups

Group	Minimum Age	Qualification	Task
Qualified Operator	18 years	Trained in handling of measurement equipment, trained in work safety for the corresponding area	Ultrasonic inspection of constructions made of concrete, reinforced concrete and stone with one-sided access
Apprentices/ Trainees/ Students:	16 years	Trained in handling of measurement equipment, trained in work safety for the corresponding area	Ultrasonic inspection of constructions made of concrete, reinforced concrete and stone with one-sided access under supervision.
Public (e.g. visitors)	No user group. The handling of the measuring device is prohibited for these persons.		
Vulnerable persons (e.g. pregnant women)	No user group. The handling of the measuring device is prohibited for these persons.		

Ambient limits

- Temperature Range:
 - Storage: From -20 °C to +60 °C
 - Operation: From -10°C to +50°C
- Relative humidity: 95%
- Contamination: Despite the provided protection according to IP 53 (dust, splash water) always try to minimize the contact of the device with particles and fluids. After use, the device must be cleaned and stored in the transport box provided for this purpose.

Reasonably foreseeable misuse**CAUTION**

The device may only be operated by trained personnel. Nevertheless, misuse is not excluded if care is not taken. For troubleshooting, see "Troubleshooting"

Problem cause	Consequence
Incorrect use of the test block	Incorrect measurement
Skewed or improper placement of the device on the testing surface	Incorrect measurement
Insufficient grip of the device, unsafe testing positions, dropping the device	Damage of casing, rechargeable battery, display, electronics. Loss of IP protection.
Insufficient attachment of the handle arm/ open fastening screws for grip adjustment	Dropping of the device and injury by uncontrolled movement of the device.

12 Safety

**WARNING**

The general safety instructions listed in this section are relate to the use of the device on workshops and constructions sites under controlled conditions.

These general safety instructions are no replacement for a risk assessment of the workplace according to BetrSichV §3, GefStoffV §6 and ArbSchG §5 and applicable additional national and international requirements by a health and safety officer or a specialist for occupational safety of the employer.

General safety instructions:

- The equipment should not be handed over to persons not aware of inherent risks of the device use or not knowing the content of this manual.
- Be sure to stand securely when measuring with the device.
- Keep a good posture during the handling of the device and avoid movements that will overloading your joints, ligaments and muscles.
- Pay attention to your environment and potential hazards during the measurement.
- Always mechanically secure the device from falling when used in elevated positions or areas.

**WARNING**

The Device contains four Class 2M laser for positioning purposes. The Laser are located at the bottom of the device.

Specific safety instructions:

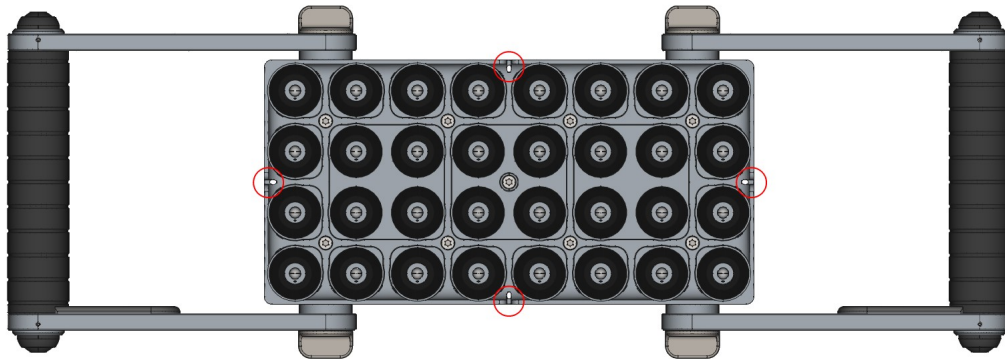

All laser outlets are marked with the following symbol

Protective measures:

- Work with laser systems may only be carried out by trained and qualified persons.
- Avoid looking directly into the laser beam (direct or reflected beam).
- If the lasers are not needed, switch the lasers off.
- If you do not work directly with the laser, keep your distance to the equipment.
- Laser radiation, may only extend as far as necessary for the task at hand.
- Do not wear watches and jewelry during the use of the lasers to avoid accidental reflections.
- The beam cross section must not be reduced.
- Laser equipment shall be installed or secured in such a way as to avoid any unintentional change in its position and beam direction, including those located in the beam path.
- A minimization requirement applies both with regard to the spatial size of the laser area and the number of people staying in the laser area.
- Keep laser under lock to prevent misuse.

13 Maintenance and Repair

NOTE

For this measuring device, calibration is imperative. It should be included in the measuring equipment monitoring of the enterprise.



CAUTION

Always keep the A1040 Mira 3D clean and maintained state. Avoid unnecessary force when using the device and always dry and clean the device before storage. For storage use the provided box with the foam inlay. Also clean and dry the insides of the box before the device is stored inside. See chapter Troubleshooting for first steps if you are in need of help or find any malfunctions.

Preventive Maintenance

Frequency	Parts Concerned		Action
Before each use	Main Device:	Housing	Check for mechanical damage.
		Transducer mechanics	Check for smooth operation, mechanical damage and cleanliness
			<div style="border: 1px solid black; padding: 2px; display: inline-block;">NOTE</div> Never try to remove the protection bellow . Never try to lubricate the the suspension system.
		Transducer tips	Check for mechanical damage and cleanliness
		Protection bellows	Check for mechanical damage and cleanliness
		Information Sticker	Check for completeness and readability.

		USB-C socket	Check for mechanical damage and cleanliness.
	Control Unit		Check for mechanical damage and cleanliness.
Before functionality check	Transducer test plate		Check for mechanical damage and cleanliness.
After each use	Main Device:	Housing	Check for mechanical damage.
		Transducer mechanics	Check for smooth operation, mechanical damage and cleanliness
			NOTE
			Never try to remove the protection bellows . Never try to lubricate the the suspension system.
		Transducer tips	Check for mechanical damage and cleanliness / Clean the transducer tips with a small, soft brush and a little moistened cloth.
	Protection bellows	Check for mechanical damage and cleanliness / clean the Protection Bellows with a small, soft brush and a little moistened cloth.	
		Information Sticker	Check for completeness and readability / Clean with a little moistened cloth / Ask service for replacement of missing or unreadable stickers.
	Control Unit		Check for mechanical damage and cleanliness / Clean with a little moistened cloth
Once per year	Complete A1040 Mira 3D system		Inspection and calibration by ACS or authorized dealer.

Control procedures and test equipment

Correct functionality is inspected by means of the test plate contained in the set. The procedure is detailed at [page 75](#).

Documentation of Maintenance

The annual inspections must be documented by factory service or the authorized person for measuring equipment monitoring.

Repair

Repair is reserved to factory service or authorized dealer.

Initial Step for Troubleshooting

In case of device failure switch OFF and ON the device. If the device problem is not solved, consult the chapter troubleshooting.

14 Technical Specification

NOTE

The technical specification is given in the A1040 Mira 3d warranty certificate, chapter 3 "Main Technical Specifications", that was given to you as part of the delivery set.

NOTE

The technical specification can be altered by ACS anytime by means of optimizing the device or for safety reasons. Please check the homepage path of [A1040 MIRA 3D](#), for the latest technical specification of the device.

15 Operation

NOTE

The given operation description of this chapter relates only to achieve a status of operation readiness. All parameters available for setting to meet the develop a testing procedure and to perform tests are described in the chapters x,y,z,

Set up of the Grip position



NOTE

The handle screws are designed to be operated by hand only. For the operation of the screws only little force is needed for secure fastening results. Never use tools on the handle screws !



Unlock the handle fastening screws on both sides of the handle by rotating them counter clockwise.

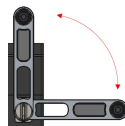

Move the Handle into one of the four possible positions.



Lock the handle fastening screws on both sides of the handle by rotating them clockwise

Repeat the operation on the other handle.

Attachment and detachment of the control device

Place the Control Unit on the Main Unit like shown in the sketch below, gripping it on the corners.

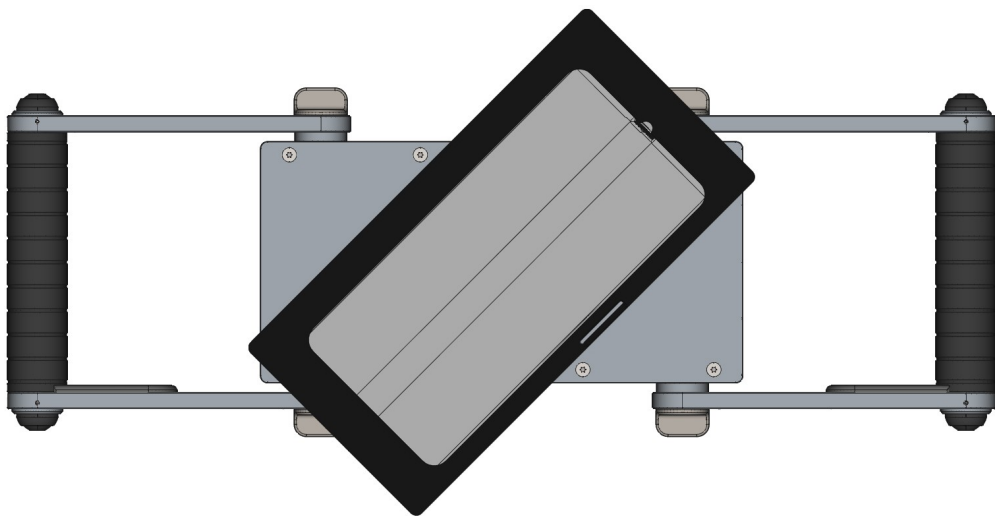

Rotate the Control Unit, gripping it on the corners, clockwise until the magnetic locking system snap into place.

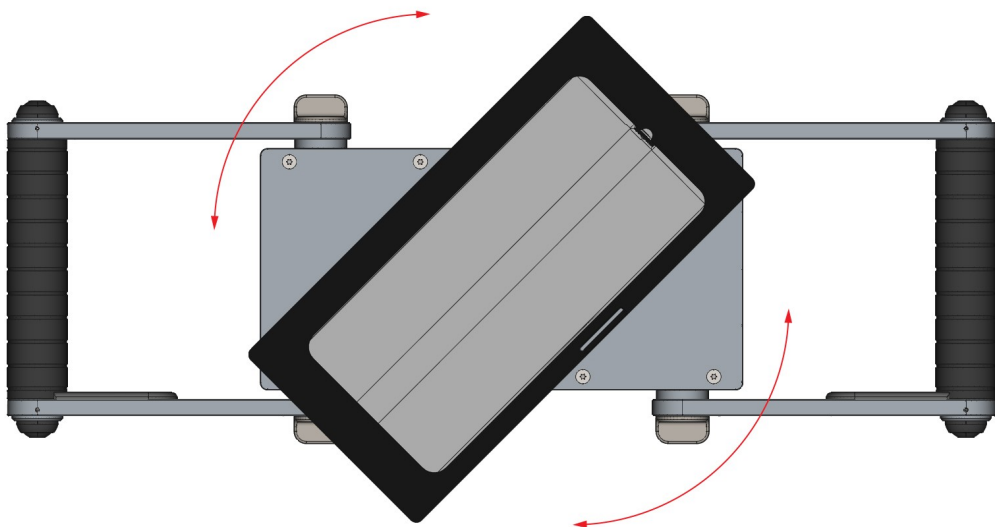

Correctly placed Control unit

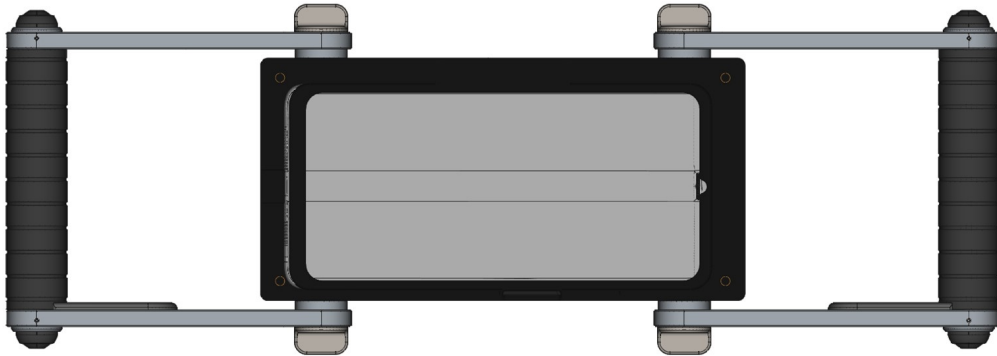

For detachment repeat the procedure backward.

Rotate the Control Unit, gripping it on the corners, until the magnetic locking system snap out of place .

Remove the Control Unit from the Main Unit.

Switching on the A1040 Mira 3D system

NOTE

Before switching on the A1040 Mira 3D system, check the status of the batteries according the chapters "Rechargeable Battery of the Main Device" and "Rechargeable Battery of the Control Unit"

Press On Key [1] for three seconds to switch the Main device on.

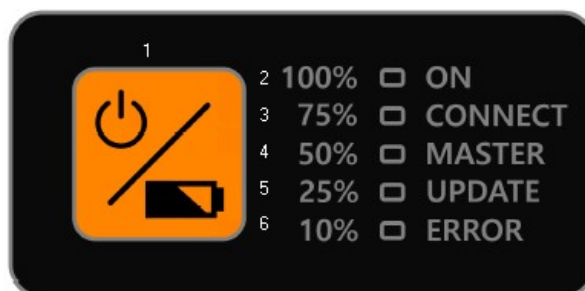

Switch on the Control Unit by pressing the On Key, shown in the figure below

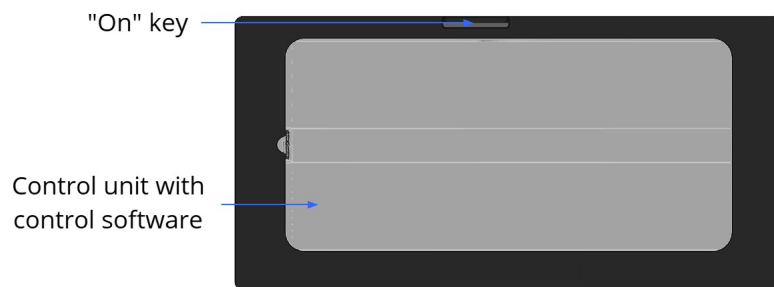

Switching off the A1040 Mira 3D system

Press On Key [1] for three seconds to switch the Main device off.

Switch off the Control Unit by pressing the On Key

16 Trouble shooting

Problem	Possible Reason(s)	Action
<p>Main Device does not switch on.</p> <p>The ON LED is not flashing green after pressing the ON key for three seconds.</p>	<p>Rechargeable Battery not charged</p>	<p>Press the ON Key short to check the Battery charging status. If the status is low (e.g. the red LED that equals 10 % is blinking) charge the batteries.</p>
	<p>The Main Device has a malfunction that can only be determined by trained service personnel</p>	<p>Send the device back for repair in its original box, or hand it over to a designated collection point for recycling.</p> <div style="border: 1px solid black; padding: 5px; text-align: center;">NOTE</div> <p>The product must not be disposed of with the domestic waste.</p>
<p>Main Device does not initialize the hardware and boot the firmware.</p> <p>The ON LED is flashing green after pressing the ON key for three seconds but is not constantly glowing after some time.</p>	<p>The software of the Main Device is malfunctioning or was damaged.</p>	<p>Switch off the Main Device by pressing the ON key for three seconds.</p> <p>Switch on the Main Device by pressing the ON key for three seconds.</p> <p>Try to perform a firmware update according chapter Update⁸⁹.</p>
	<p>The Main Device has a malfunction that can only be determined by trained service personnel</p>	<p>Send the device back for repair in its original box, or hand it over to a designated collection point for recycling.</p> <div style="border: 1px solid black; padding: 5px; text-align: center;">NOTE</div> <p>The product must not be disposed of with the domestic waste</p>
<p>Main device is not detected by mobile unit.</p>		
<p>Laser does not work or is blurred</p>	<p>Dirt or or a small item is blocking the laser beam outlet.</p>	<p>Switch off the laser LEDs by the control software.</p>

		<p>Check if the LEDs are off by placing the device on white A4 sheet of paper, or similar. .</p> <p>When the LEDs are off, turn the deice to the and clean the laser beam outlet with a small blower ball, soft brush or peace of cloth.</p> <p>Check the outlet and the lens for cleanliness.</p> <p>Check the function by placing the device on on white A4 sheet of paper, or similar and switch the laser LEDs on by the control software.</p>
		<p> WARNING</p> <p>Never look directly in the laser beam and make sure, that the laser beam is never directed to the eyes of any bystander. Also avoid mirroring surfaces like glass, liquids or polished metal objects.</p>
	<p>The LED is damaged</p>	<p>Send the device back for repair in its original box, or hand it over to a designated collection point for recycling.</p> <p>NOTE</p> <p>The product must not be disposed of with the domestic waste</p>
<p>Transducer is stuck / suspension is not working</p>	<p>Dirt intrusion due to damaged or loosened protection bellow.</p>	<p>Check the protection bellow for damage and if it is disassembled. A well assembled an intact bellow is shown in the sketch below.</p>

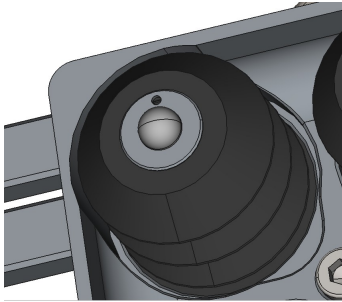
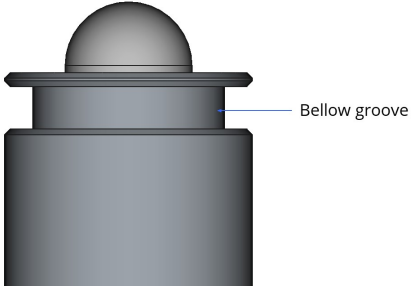
		 <p>If the bellow is disassembled, carefully try to retract the bellow until the sensor suspension is visible. Try to clean the suspension with a small brush and a little moistened cloth.</p> <p>Check if the suspension is working now.</p>
<p style="text-align: center;">NOTE</p> <p>Never try to remove the protection bellow .</p>		<p>Place the bellow back and make sure the end of the bellow rests now in the designated groove.</p>
<p>Never try to lubricate the the suspension system.</p>		 <p>If the bellow is damaged, it must be replaced by a service technician.</p>
	<p>Spring malfunction/damage or damage at the mechanical transducer guiding system.</p>	<p>Send the device back for repair in its original box, or hand it over to a designated collection point for recycling.</p> <p style="text-align: center;">NOTE</p> <p>The product must not be disposed of with the domestic waste</p>
<p>Main device is not detected by the Mobile Unit</p>	<p>Malfunction during the coupling process</p>	<p>Check if the On LED on the Main Device is glowing green constantly.</p> <p>Switch off the Mobile Unit.</p> <p>Switch on the Mobile Unit</p>

		Go to chapter at page 88 and follow the instructions for the device coupling process.
	Software malfunction	Check if your Control Software on the Mobile Unit is starting properly. If the software is not responding properly, reinstall the software on your Mobile Unit.
Plattentest fail		
Main Device does not switch off after pressing the ON key for three seconds.	The control software is malfunctioning.	Disconnect the Mobile Unit form the Main Device. Disconnect all cables from the Main Device. Retry switching off by pressing the ON Key for three seconds
	The Main Device has a malfunction that can only be determined by trained service personnel	Let the Main Device switched on, until the batteries are discharged enough and no LEDs is lit any more. Send the device back for repair in its original box, or hand it over to a designated collection point for recycling.
		NOTE
		The product must not be disposed of with the domestic waste.

17 CE Certificate



Declaration of Conformity according to EMC Directive 2014/30/EU

The manufacturer / distributor

ACS-Solutions GMBH, Science Park 2, 66123 Saarbrücken Germany

hereby declares that the following product

Product name: Low-Frequency Ultrasonic Tomograph
Trade name: Ultrasonic measuring device
Model name: A1040 MIRA 3D

complies with the provisions of EMC Directive 2014/30/EU, including any changes in force at the time of the declaration.

The following harmonized standards have been applied:

EN 55011:2016	Industrial, scientific, and medical devices - Radio interference - Limit values and measurement methods
EN 61000-6-2:2015	Electromagnetic Compatibility (EMC) - Part 6-2: Basic Technical Standards - Immunity for Industrial Sectors
EN 61000-4-2:2009	Electromagnetic Compatibility (EMC) - Part 4-2: Test and measurement methods - Testing of immunity against the discharge of static electricity
EN 61000-4-3:2006+ A1:2008+A2:2010:	Electromagnetic Compatibility (EMC) - Part 4-3: Test and measurement methods - Immunity testing against radiofrequency electromagnetic fields

The test results were documented in EMC Test Report 83418_24112020_A1040 MIRA 3D from 30/11/2020 by SGS TÜV.

The following national or international standards (or parts/clauses thereof) and specifications have been applied:

EN 61010-1 Safety requirements for electrical equipment for measurement, control, and laboratory use - Part 1: General requirements

Procedures for carrying out risk analysis

Directive 2014/30/EU, Annex I, point 1 and Annex II Module A

Risk assessment procedures

DIN ISO/TR 14121-2 Safety of machines - Risk assessment - Part 2: Practical guide and process examples, 6.3 Risk graph

Location: Saarbrücken

Date: 11.12.2020

Dr. Andrey Bulavinov (Managing Director)



18 B-Scan

B-Scan serves for fast randomly measurements along the object. These measurement are considered to be spatially independent. In a short period of time operator can optimize measurement parameters taking in to consideration different areas of the object. Measurement of the object thickness as well as sound velocity can be also done on the fly. Moreover, examination suspicious areas, location of reinforcement, bots is also offered.

18.1 Main parameters

Main parameters tab of B-Scan mode mostly contains parameters which affect ultrasonic characteristics of measured signals. The screen of main parameters tab and its description are given below.

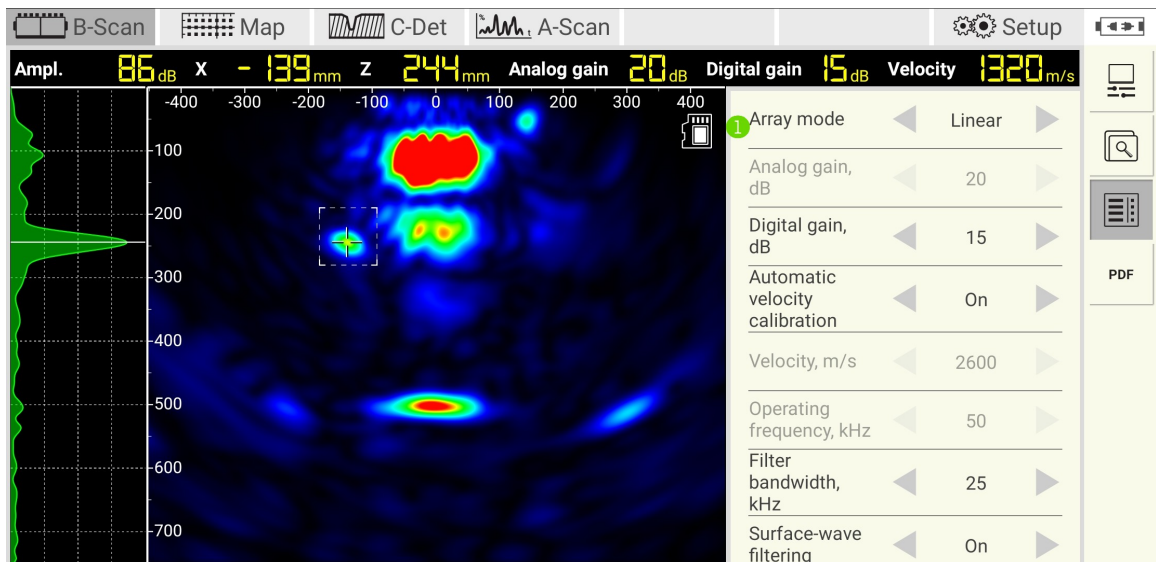

Table 1: Description of controls

Lable	Description
1	Panel with list of parameters. Operator can scroll the list of parameters up and down by using touch. Put a finger on the panel, hold it pressed and move it up or down

Table 2: Description of parameters

Parameter	Description
Array mode	Switches between linear or matrix device mode.
Analog gain, dB	This parameter can be used to increase the analog signal amplitude before it is being transformed into a digital signal by A/D-converter. Analog gain is expressed in db. It is preferable to apply the analog gain first since it extends the usage of A/D-converter digital resolution. Decrease analog gain in case of saturated signals.
Digital gain, dB	This parameter can be used to increase the digital signal after it has passed the A/D-conversion. Digital gain is expressed in db. Digital gain does not improve digital resolution rather equally amplifies both signal and noise. The parameter allows to improve contrast of resulting images.
Operation frequency, KHz	Sets frequency of excitation pulse on ultrasonic transducers. Default frequency is 50KHz-
Filter bandwidth, KHz	Digital filter bandwidth with central frequency equal to operation frequency.
Show TGC	Option to show/hide TGC curve on an A-Scan.
TGC, dB/ μ s	Defines slope of analog TGC expressen in dB/ μ s
TGC delay, μ s	Defines zero-delay of TGC curve
Transmitter pulse sequence	Defines number of half-periods for excitation pulse. Value 0.5,1,... stand for 1 half-period, 2 half-period (or one period) etc.

18.2 Display parameters

Display parameters allows user to adjust representation of inspection results in a best suitable way. Main screen of display parameter tab and corresponding description are given below.

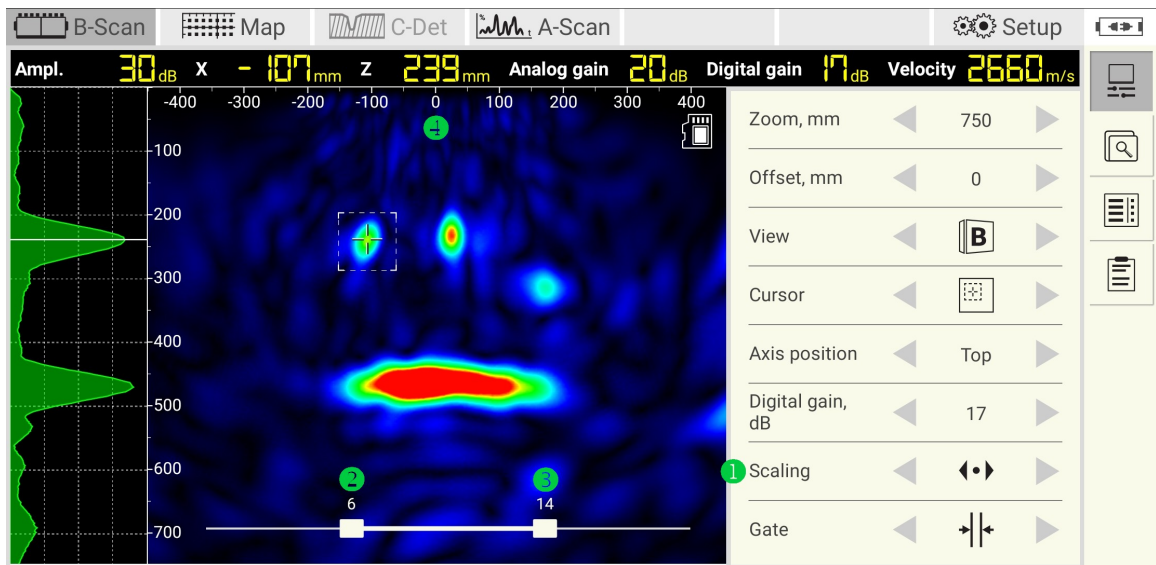









Table 3: Description of controls

Lable	Description
①	Tab with listed display parameters
②	Start gate control. Defines first cross-section to be projected
③	End gate control. Defines last cross-section to be projected.

Table 4: Description of parameters

Lable	Icon	Description
Zoom	-	Parameter specifies limit of B-Scan inspection depth. Available in liner array and matrix array mode.
Offset	-	
View		Data are shown as a flat B-Scan (front view) image. In matrix array mode the operator can setup desired projection depth by means of Gate control.
		Data are shown as 3D volume. Available in linear and matrix array mode
		Data are shown as flat C-Scan (top view) image. In matrix array mode operator can setup desired projection depth by using of Gate control.
Cursor		Type of cursor offers for the operator automatic search of a maximal amplitude inside the cursor area. The position of the maximal amplitude is pointed by cross-lines. A-scan waveform corresponds to the horizontal position of the cross-lines.

		Type of cursor offers operator to manually specify position of cross-lines over b-scan. Horizontal and vertical lines are hidden in order to avoid obstruction of information shown on b-scan.
		Classical type of cursor with elongated vertical and horizontal cross-lines.
Axis position	-	Allows changing the location of the x-axis  on the B-Scan. Three options are available: top, bottom or hide. Change the x-axis location if it obstructs the view to an indication on the B-Scan
Digital gain	-	Refer to page ⁴⁷
Scaling		Depth and width relations of B-Scan or C-Scan are proportional. The operation can scroll an image both left and right using touch.
		B-Scan or C-Scan are fitted to screen. Depth and width proportions are not preserved.
Gate		Allows the operator to examine data using cross-sections
		Operator can setup a number of cross-sections which will result into a single image.

18.3 File manager

The file manager  provides the saving, loading, deleting, sharing, renaming, and creating measurements.

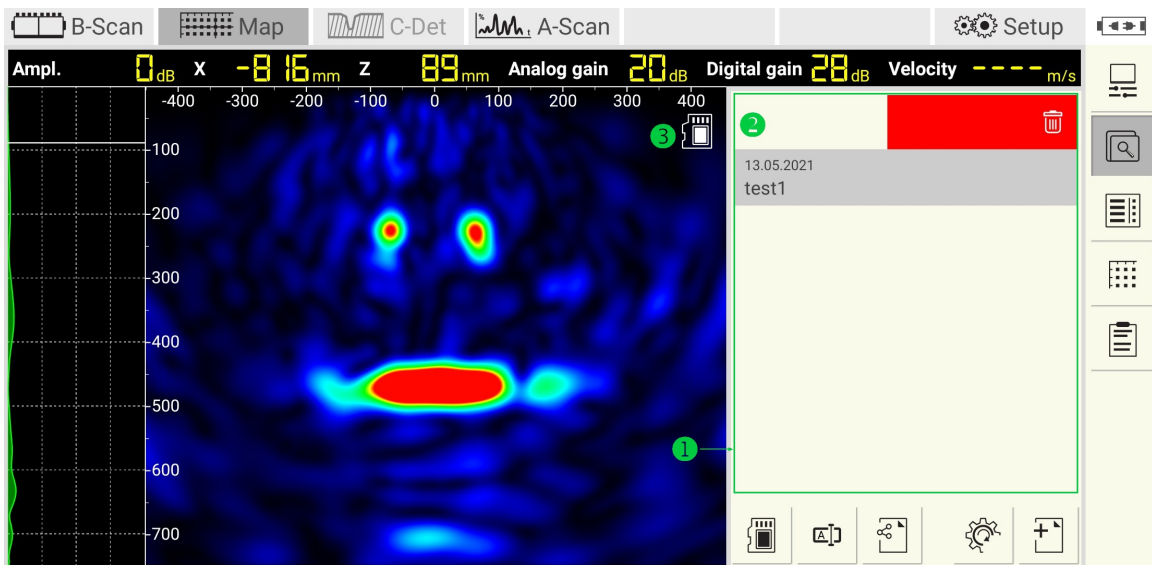

Figure 5: File manager



Mode

The file manager causes the app to switch between the `online` and the `offline` modes. In `online` mode, the app receives the data from the tomograph. In `offline` mode, the app operates with some saved data.



NOTE

The online is only available if the tomograph is online. For more information refer to [page 68](#).

File manager panel

The `file manager` has a panel with a list of measurements **1**, Figure 5. Each item in the list has a name and the date and time when it was saved or changed. The list can be scrolled by touching with a finger and simultaneously moving up and down. Short tip on the list causes the selection of the desired measurement followed by loading of corresponding data. The app switches to `offline` mode. The icon  indicates whether the loading finished successful, refer to **3**. Repeated tipping of the selected item switches the app to `online` mode. The indicator  hides. The list allows deleting an item by holding long touch with a simultaneous horizontal right to left movement **2**.

Saving

Press the button  to save the current data and parameters. After pressing the button the keyboard  appears, Figure 6. Edit the name using the keyboard.

Confirm the changes with .

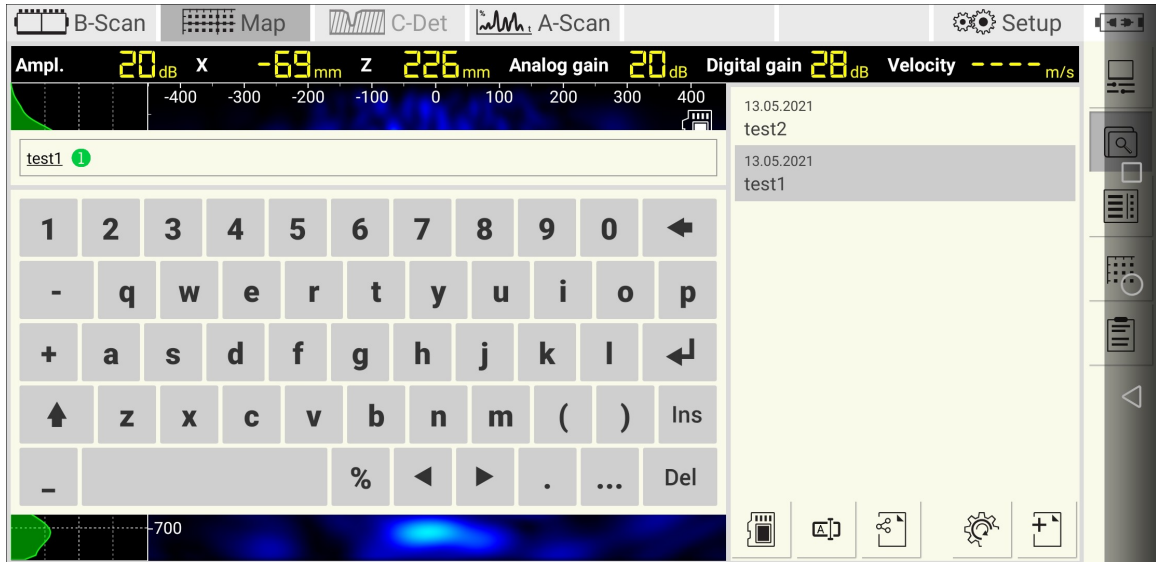



Figure 6: Saving dialog keyboard



CAUTION

Re-save any changes made on offline data. Otherwise, the changes will be lost.

Renaming

Press the button  to rename the measurement. After pressing the dialog similar to 6 appears. Change the name and confirm the renaming with .

Sharing

Press the button  to share the current measurement. After pressing the icon, the android operation system offers to choose a third-party sharing software. It can be an email client, a cloud or any messenger. Install the sharing software before using this option.

NOTE

The app shares only *offline* data. Save the online measurement before sharing.

Default reset

Press the button  to create an online measurement with the default parameters.

NOTE

The defaults are the parameters recommended by the manufacturer. It is recommended to use the defaults when you start using the application.

New measurements

Press the button  to create a new online measurement with the parameters copied from the current measurement.

NOTE

To create an online copy of the offline measurement, load it first. After loading press .

19 MAP

MAP mode allows the operator to carry out areal scanning of inspected objects. The operator is given a great variety of function to setup: area of interest, its dimensions, step size, scanning direction etc. Apart from this setting, the software has a number of integrated visualization features, data representation modes and analysis tools. Operator of can observe results of scanning even in real time while progressing with data collection. Description of functions, parameters and settings is given in the following chapters.



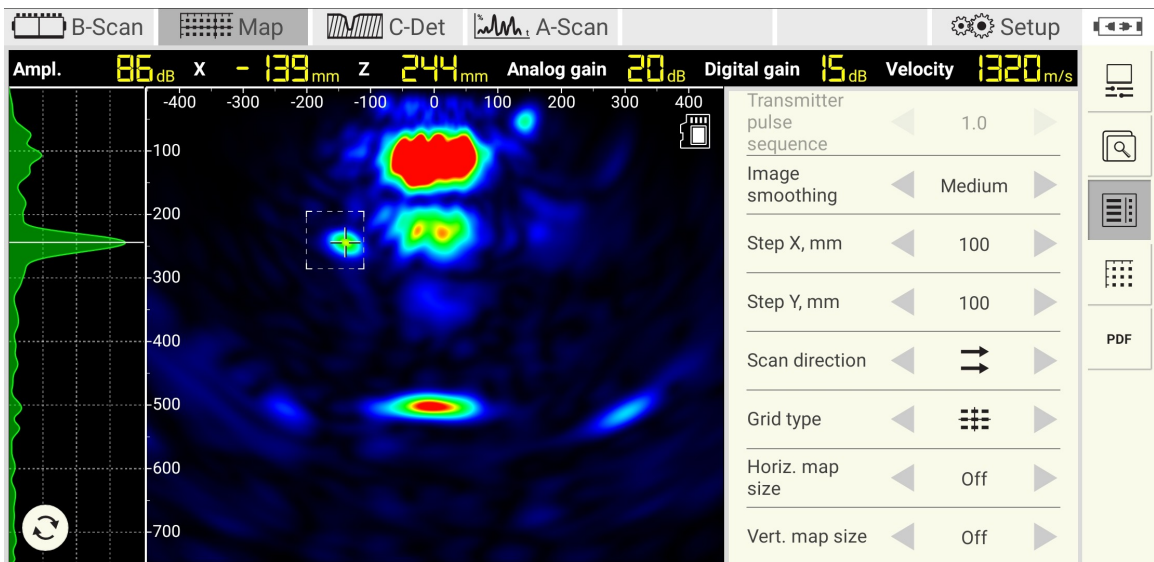

19.1 Main parameters

Main parameters of MAP mode are listed in corresponding tab as it shown below.



In MAP mode in comparison to B-Scan mode the list of main parameters has been extended. For description of standard parameters refer [to](#)^[47]. Additional MAP parameters are listed in table below.

Table 5: Description of parameters

Lable	Icon	Description
Step X		Defines distance between measurement positions along X axis
Step Y		Defines distance between measurement positions along Y axis
Scan direction		Defines next measurement position with respect to the current one. Left, right, up and down options are available.
Grid type		Allows operator to load data from the selected measurement position.
		Allows operator to project all data to a single (panorama) image from the selected row. Merging is carrying out in accordance with xy coordinate.
		Allows operator to project all data into a single (panorama) image from the selected column. Projection is carrying out in accordance with XY coordinate.
		Allows operator to project all data from the selected area into a single (panorama) image.
Horiz. map size		Defines the limit of measurement positions along X axis . After reaching the last position operator will be offered to start a new horizontal line. Operator may switch off the limits.
Vert.map size		Defines the limit of measurement positions Y axis. Behaves similar to Horiz. map size

19.2 Display parameters

Display parameters in MAP mode are the same as in B-Scan mode. Please, refer to the list of display parameters [here](#)^[48].

19.3 File manager

File manager in MAP mode has similar functionality as the manager in B-Scan mode. Please, refer to file manager description [here](#).^[50]

19.4 MAP manager

MAP manager parameters are listed in the corresponding tab as is shown below.

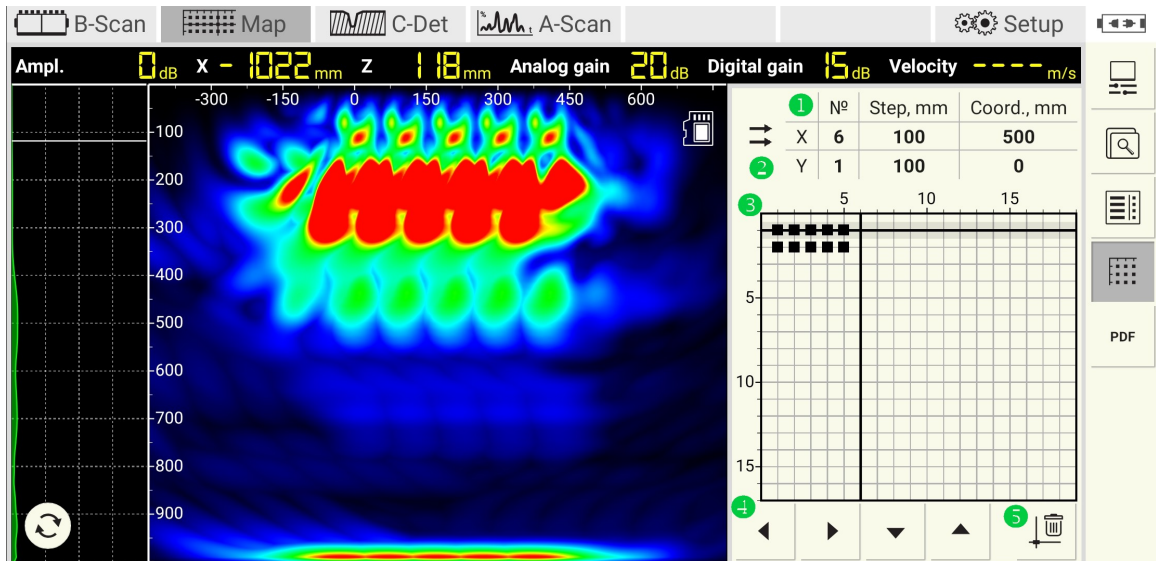

Table 6: Description of parameters

Label	Description
[1]	Table presents main parameters of the map. First column (Number) shows cursor/device coordinates in XY plane. Second column (Step) shows step size along X and Y axis in. Third column (Coord.) shows actual position of cursor/device in XY plane.
[2]	Indicator depicts scanning direction. There are following options: left, right up and down. Operator can setup scanning direction over main parameter tab.
[3]	Map grid indicates position where data were taken. Following actions are available on the map grid: <ul style="list-style-type: none"> • pan grid area. This option can be activated by double click on any free grid space. Hold touch and move a finger to pan • move cursor by touch or arrow control [4] • delete data set at selected position by pressing on trash bin button [5]

20 C-Det

C-Det (`crack detection`) mode allows the operator to evaluate open crack depth. Notice that the evaluation algorithm requires the crack length on the surface to be larger than 100 millimeters to provide realistic results. C-Det works only in `matrix array` mode. Switch off `automatic velocity calibration` since the surface wave does not propagate through the open crack. For `main parameters`, `display parameters`, and `file manager` operation, please, refer to the corresponding chapters of [B-Scan](#).^[47]

Measurements

Perform the measurements as follows:

- Keep attention that the crack is located between the fourth and fifth row of transducers, **Figure 6**
- Switch off `automatic velocity calibration`
- Set desired `velocity`. If velocity is not known try to estimate it on crack-free surface or using back-wall.

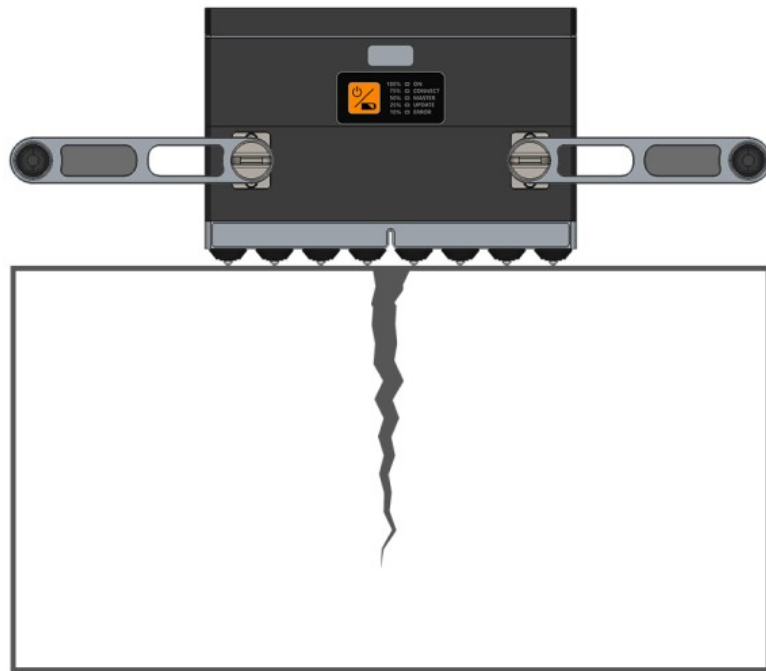

Figure 7: Crack-depth estimation

Evaluation

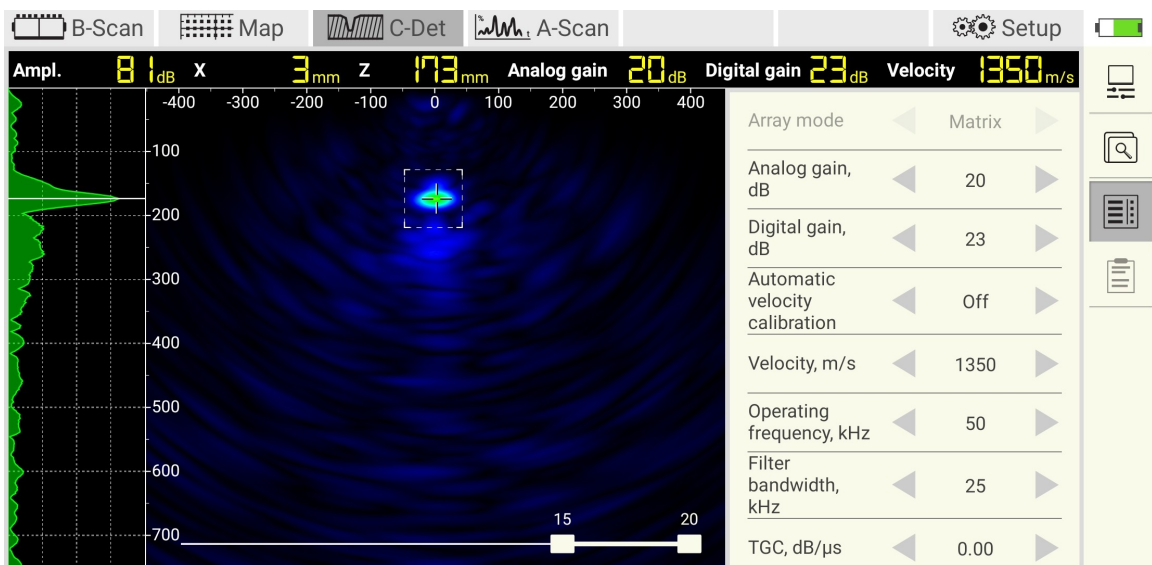

Figure 8: Crack-depth evaluation

- Try to locate the area of interest using the cursor (Figure 8)
- Estimate X and Z location of the crack-pitch

21 A-Scan

A-Scan mode allows to perform the following operations: observation of waveform measured by specific transducers; fine tuning of analog and digital gain; analysis of the signal with respect to noise, tuning of TGC, time estimation using gates etc. Main screen of A-Scan mode is given below.

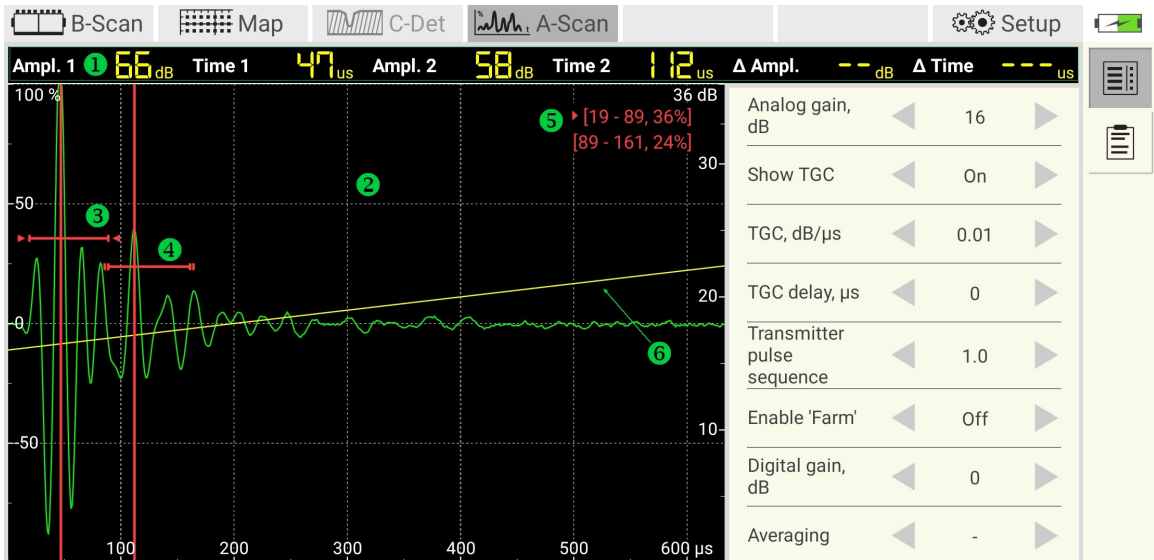











Table 7: Description of visual elements

ID	Description
1	Main information panel. It shows the following parameters: first/second gate max. amplitude (Amp11./Amp12.) in decibel, time of max. detected amplitude (Time1/Time2) in first/second gate, detected amplitude difference (Amp11-Amp12.), detected time difference (Time1-Time2)
2	A-Scan view. Double click on A-scan area activates A-scan sub-mode. In this sub-mode operator can pan a-scan horizontally, zoom in, zoom out or reset the view.
3	First gate control. Operator can move gate horizontally or vertically, can increase or shorten gate length. Long press on A-scan area forces gate to appear close to the touch point. Operations with the first gate are available only in first gate sub-mode. In order to switch to first gate sub-mode the operator may click on first gate control or activate first gate sub-mode using active touch control.
4	Second gate control works similar to the first one.
5	The indicator gives the information about the gates. The triangle points to the currently selected gate. The number in brackets introduces the start and the end of the gate expressed in μs. The percentage amplitude follows the comma.

Table 8: Description of parameters

Parameter	Icon	Description
Farm view	-	Refer to the next section.
Averaging	-	Averaging factor can be set to a value from 2 to 16. Software uses averaging factor to compute a-scans from a number of successive following measurements. Averaging can be applied only in A-Scan mode. Set '-' to switch averaging off.
Transmitter	-	Transmitter control allows the operator to select column of transducers in case of linear array mode or single transducer in case of matrix array mode.
Receiver	-	Receiver control allows for the operator to select a receiver which waveform is to be depicted on a-scan.
Active touch		Option activates a-scan sub-mode. Operator can work with a-scan using touch.
		Option activates first gate sub-mode. Operator can work with the first gate using touch
		Option activates second gate sub-mode. Operator can work with the second gate using touch.
Algorithm		Algorithm for amplitude detection: maximum amplitude within first gate. Second gate is off.
		Algorithm for amplitude detection: waveform and gate first crossing within first gate. Second gate is off.
		Algorithm for amplitude detection: difference between maximum amplitudes within first and second gate.
		Algorithm for amplitude detection: difference between amplitudes in the positions where waveform and gates first crossing.
Ascan		Normal waveform representation
		Rectified waveform representation
		Waveform envelope

21.1 Farm View: A1048 MIRA 3D

Enabling the farm view option allows for the operator to show all 32 A-scans on a single graph called `farm view`. Such a bird's-eye view may help to diagnose the device for broken transducers, electronic failure, environmental noise distortions. The operator can use the `farm view` in both `linear` or `matrix` array mode.

Transducer assignment

The A1040 MIRA 3D addresses the transducer with a column and a row number separated by a dot, for example, `column.row`. The transducer with a minor address `1.1` has its position at the upper left corner of the instrument. The column number increases from left to right. The row number increases from up to down, see Figure 9.

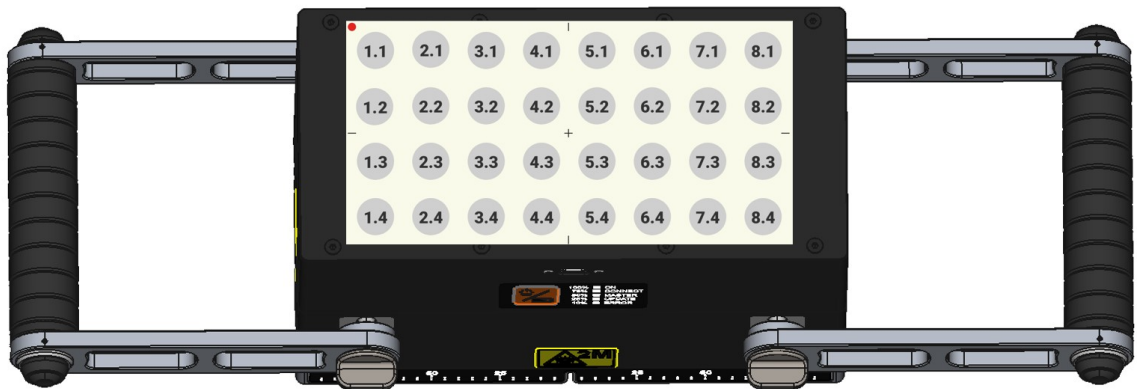

Figure 9: Transducer assignment scheme

Linear mode

In the linear array mode ①, the operator can select a group of four transmitting transducers. Tap on the transmitter control ②. Select the group (or column) of transmitters in the rising dialog. Transmitters become black ③. The receiver ④ has a red border (Figure 10).

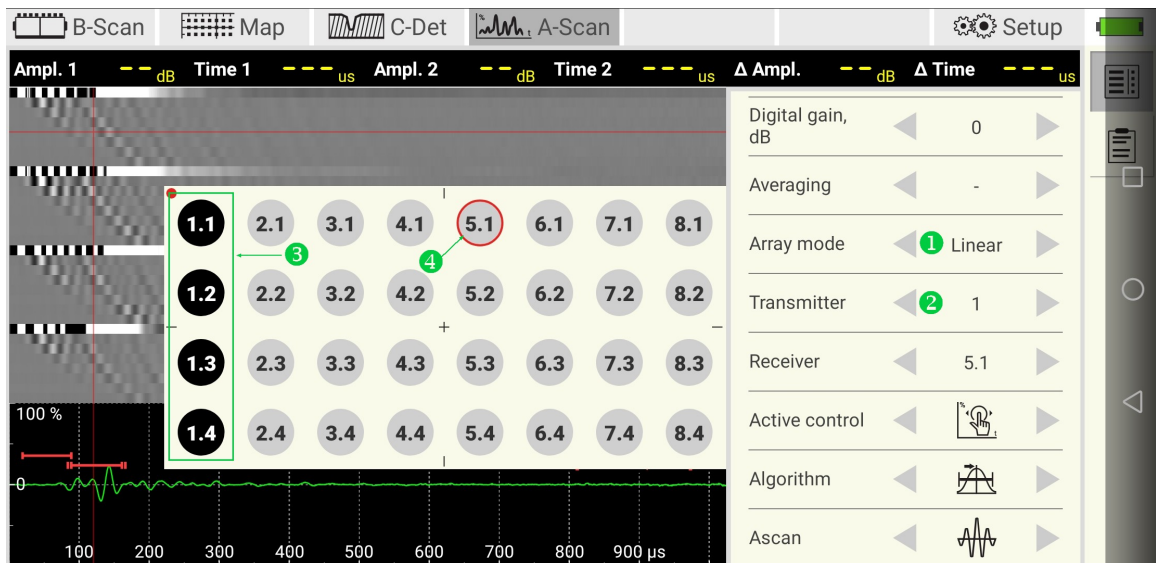

Figure 10: Selecting the group of transmitters

Figure 11 illustrates the receiver selection. Use the control u to assign the receiver. The rising dialog indicates the receiver by black color v and transmitters with a red border w. Alternatively, the receiver can be selected with the help of the horizontal cross cursor x. Activate the cursor by long tap on farm view or using y. Select the desired a-scan (the corresponding receiver will be shown in u) by moving the cursor vertically.

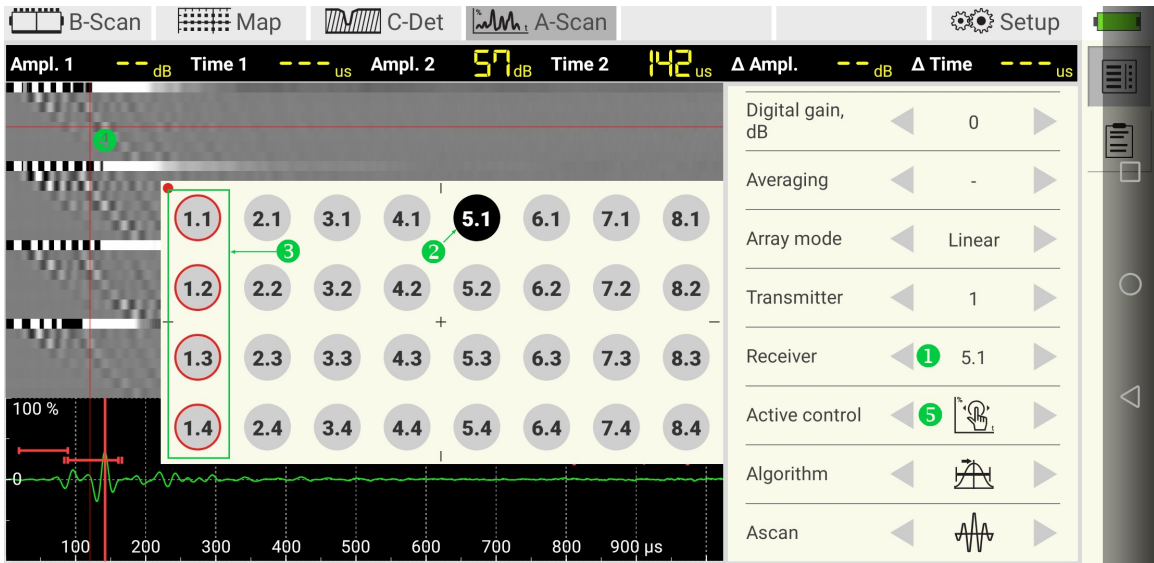

Figure 11: Receiver selection

Matrix mode

In the *matrix* mode, the operator can select rather a single transmitter then a group ① (Figure 12). Receiver selection flow does not change.

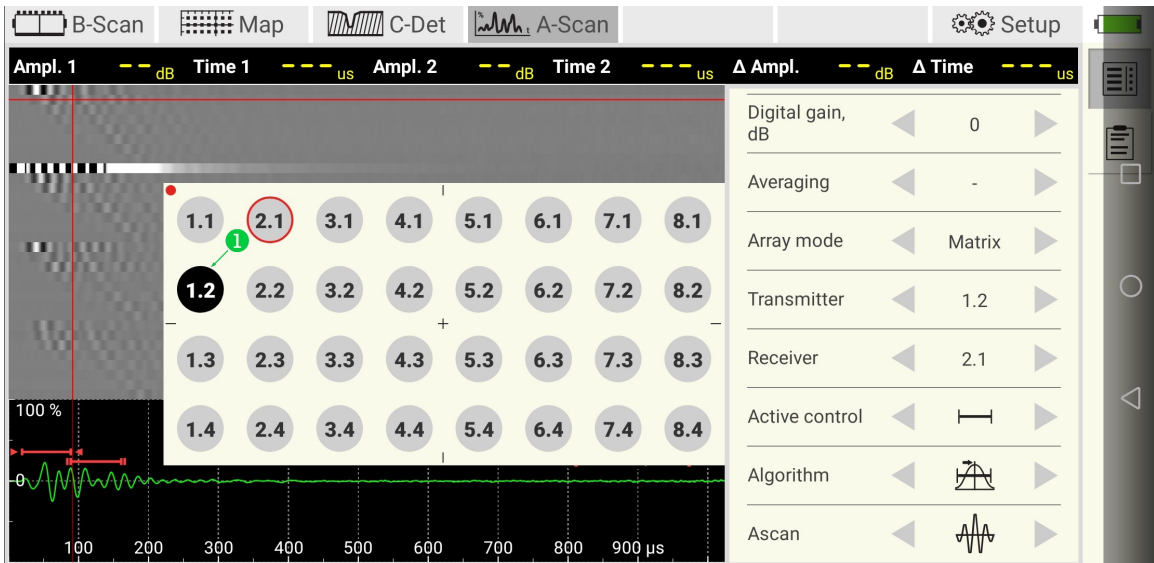

Figure 12: Selecting a transmitter in matrix mode

21.2 Farm View: A1048 MIRA 3D PRO

The farm view of A1040 MIRA 3D PRO works equally to the farm view of A1040 MIRA 3D. The A1040 MIRA 3D PRO addresses the transducers of the master **[M]** and the slave **[S]** throughout (see Figure 13 ① and ②). Thus, all the 64 transducers may work independently as transmitters or receivers, separately or in groups.

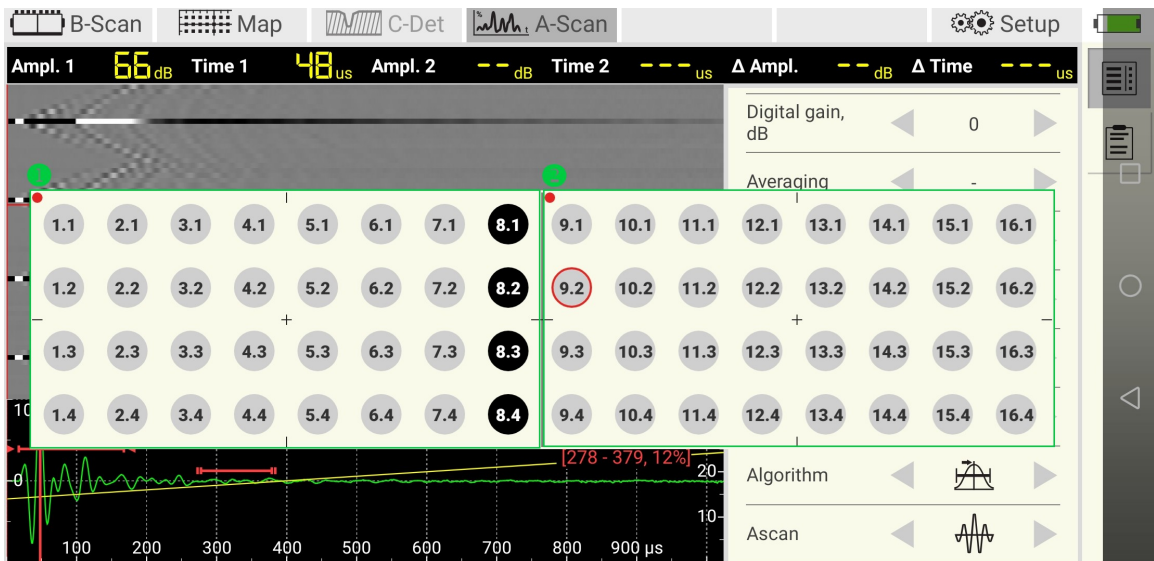

Figure 13: Selection a group of transmitters in linear mode

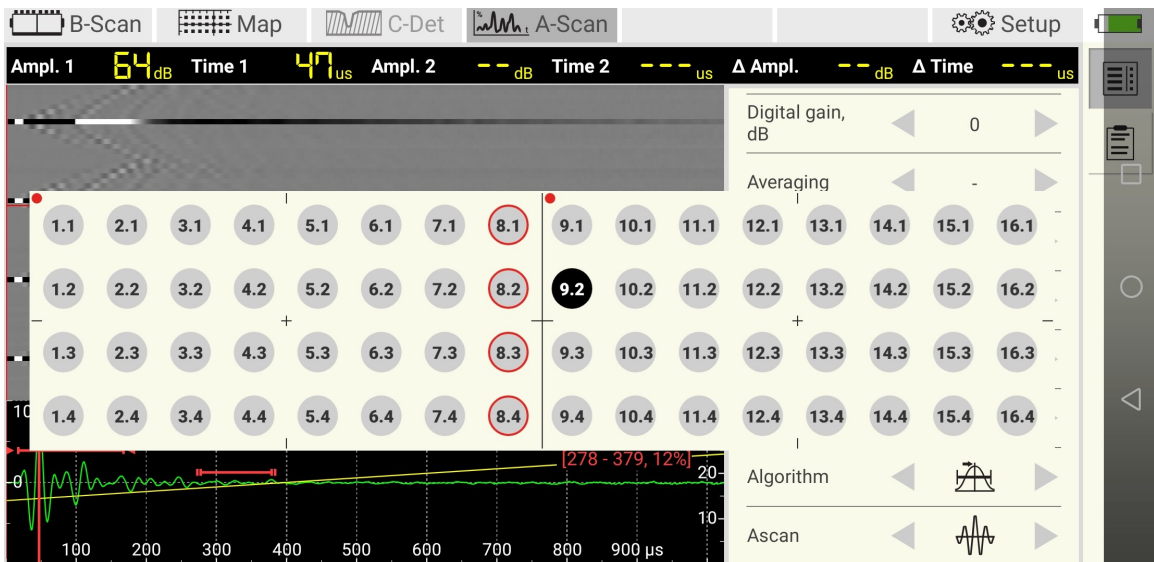

Figure 14: Selecting the receiver in linear mode

22 Reporting

The reporting function provides some tools for creation, management and sharing of the reports. B-Scan, MAP, C-Det and A-Scan modes support reporting.

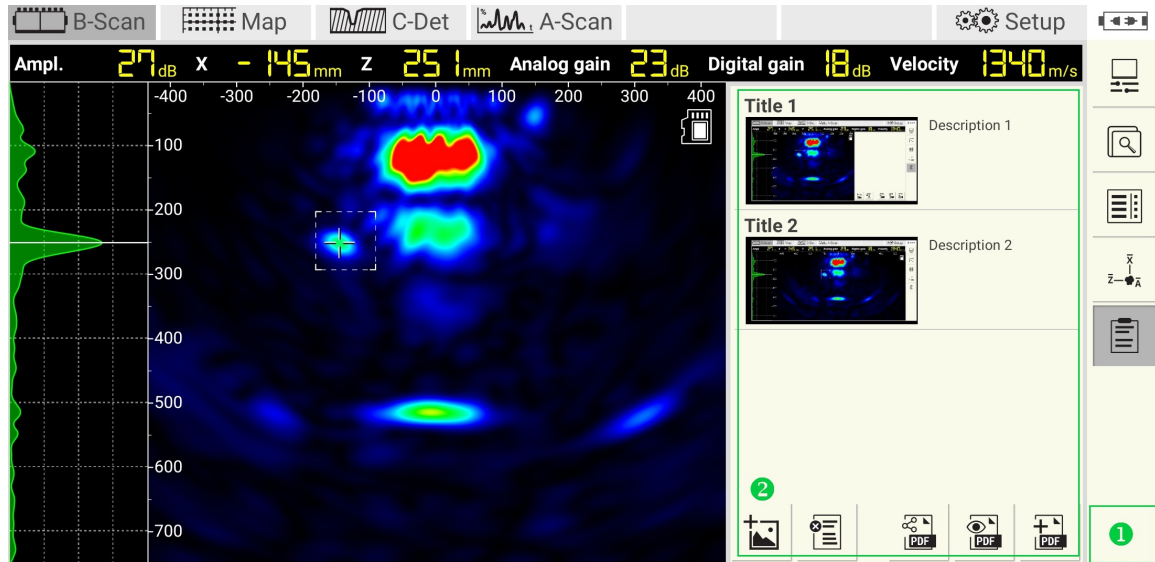

Figure 15: Report screen

Reporting tools

The following table lists the available reporting tools.

Icon	Description
	Generate report. After editing the report, use this tool to regenerate it. The app raises a dialog window while creating a pdf file.
	Show report. Use this tool to open a pdf file with a pre-installed pdf-reader.
	Share report. After pressing the icon, the android operation system offers to choose a third-party sharing software. It can be an email client, a cloud or any messenger. Install the sharing software before using the report.
	Clear report. After pressing the tool deletes all report screenshots.
	Add image. The tool adds an image from the gallery. The operator may enter a title and a description.

Taking a screenshot

Take a screenshot by holding the finger on the active area **1** for about one second. This area is available at any time, whether panel **2** is open or closed. Every time starting the application, the android operation system asks for permission for taking screenshots. Confirm the rising dialog with *START NOW*:

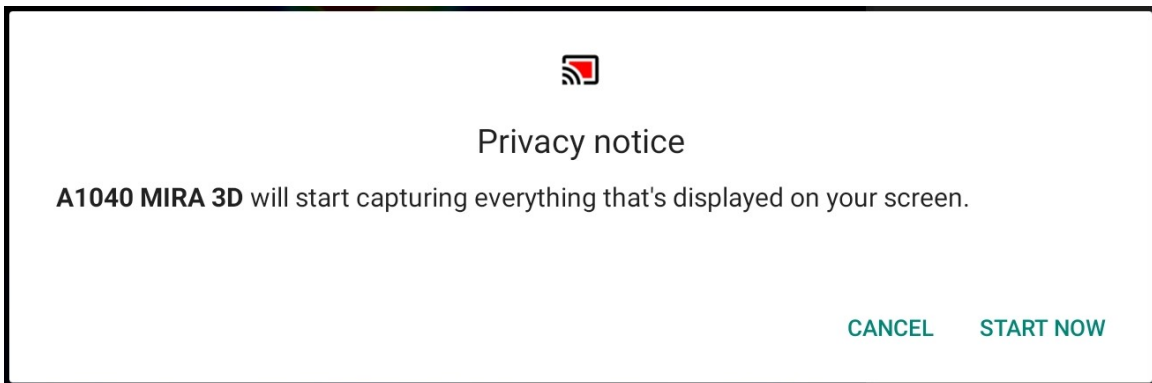

Editing a screenshot

The operator may edit the title and the description of the screenshot at any time. The editing dialog has fields ❶ and ❷ for that. Use the keyboard ❸ for typing, Figure 16

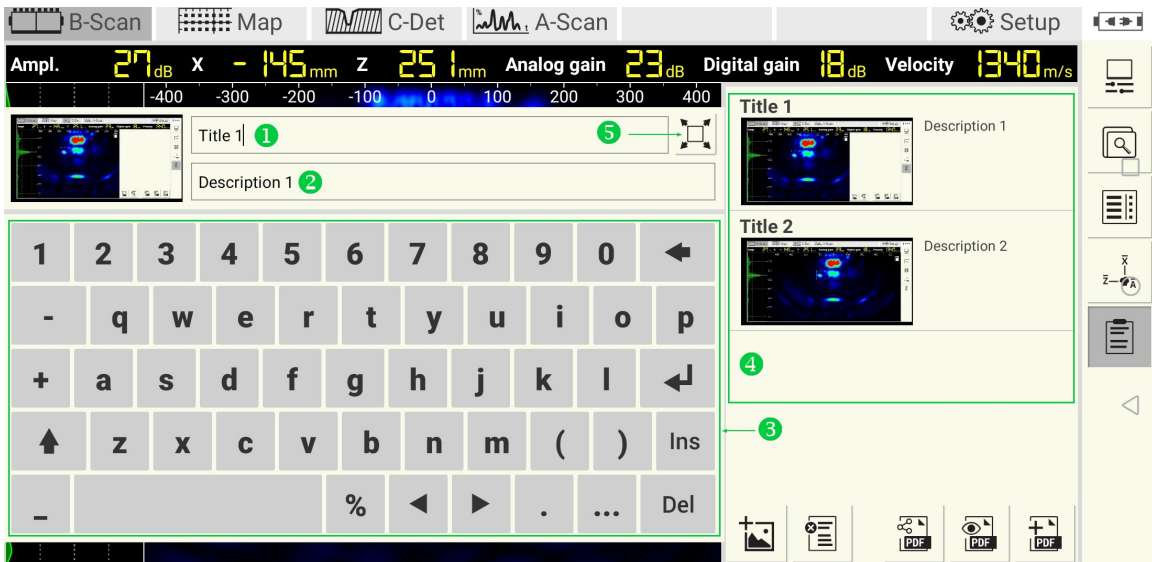



Figure 16: Screenshot editing

Confirm the changes with  to add screenshot to the list ❹. Use the zooming tool ❺ for enlarging the screenshot.

After pressing the zoom  button The fields title and description become uneditable, Figure 17. Use the unzooming tool ❶ to switch to the previous view.

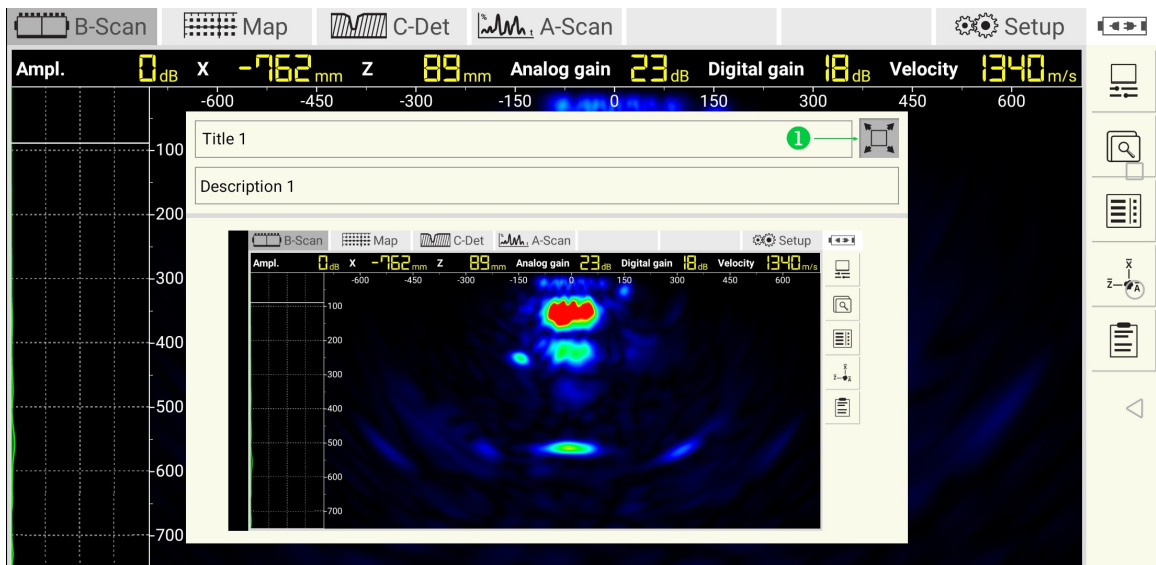

Figure 17: Screenshot zooming

List of screenshots

Delete a screenshot from the list by swiping the item from right to left, see ① on Figure 18. While swiping, the basket is going to replace the item. Confirm the deleting with YES or abort with NO.

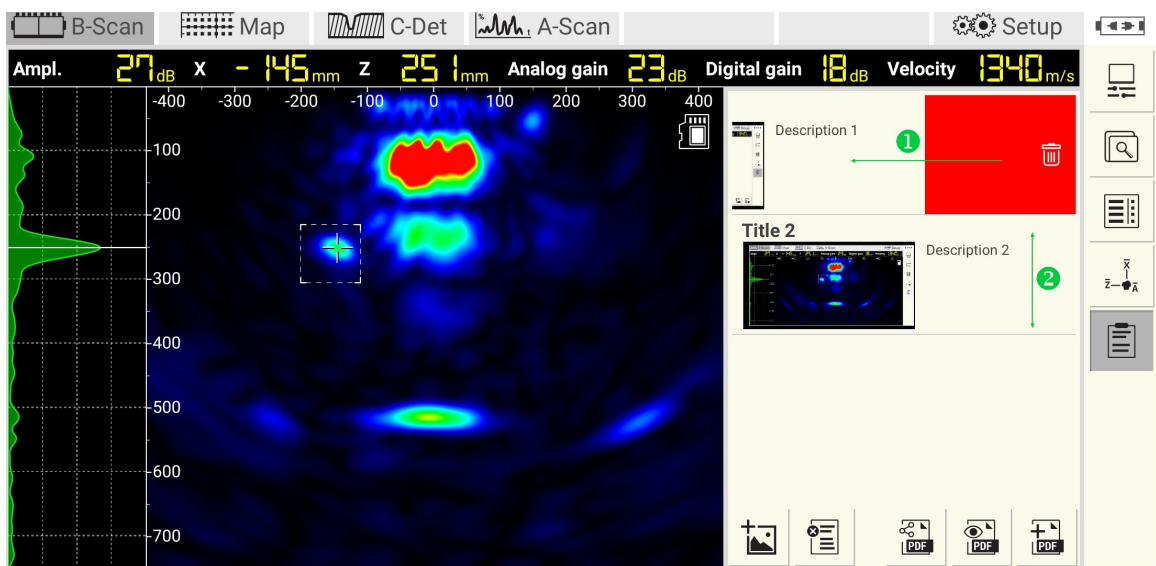

Figure 18: Working with list of screenshots

Scroll the list vertically to find the desired item (see ②). Change position of the item in the list using drag&drop.

23 Setup

Setup mode allows for the operator to adjust system parameters, to scan for online devices, to configure instrument, to set master and slave instruments, to carry out transducer self test.

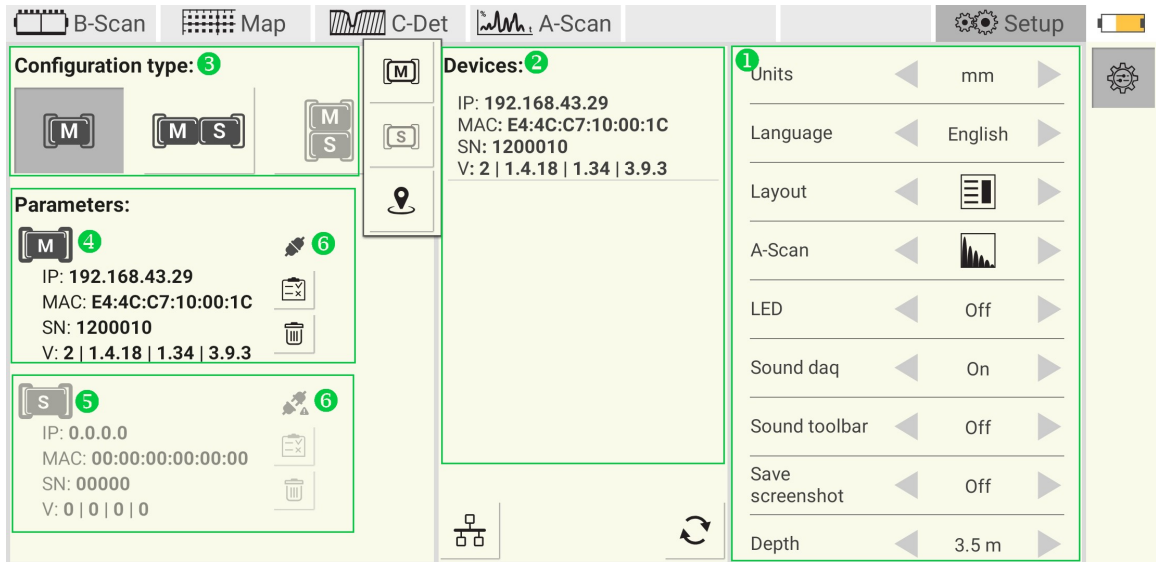

Table 19: : Description of elements





















ID	Description
①	System parameters panel. Description of parameters see in the table below
②	Device panel lists online instruments found during the scanning process. The App reads and shows system information that includes: IP address given by the access point, MAC address, instrument serial number and firmware version number. Double click on a found instrument rises a pop up menu with three options described described in this table.
	Sets instrument as master. Current master will be overridden.
	Sets instrument as slave. Current slave will be overridden.
	Button initiates I'm here feature. By tapping it the operator forces the selected device to blink by its master LED
	Button initiates reconnection of tomographs for a defined configuration the selected configuration type. Use this routine if the automatic connection fails.
	Button calls scanning for online instruments
③	Instrument configuration section. The operator can specify one of the following configurations: A1040 MIRA 3D  or A1040 MIRA 3D PRO   . The configuration A1040 MIRA 3D PRO   is currently not available.
④	Sub-panel informs the operator about current settings for the master
⑤	Sub-panel informs the operator about current settings for the slave
⑥	Indicator shows whether the master/slave is currently connected. The indicator has two states: disconnected  and connected 
	Button calls a routine for the transducer test. Detailed description of the transducer test procedure is given on page 75 .
	Button removes the current instrument from the list

Table 9: Description of parameters

Parameter	Icon	Description
Units	-	Switches between metric or non-metric units
Language	-	Switches user interface language
Layout		Parameter selects right hand side location of the app control panel
		Parameter selects left hand side location of the app control panel
A-Scan		A-Scan is plotted as empty waveform
		A-Scan is plotted as filled waveform
Cursor		Type of cursor offers for the operator automatic search of a maximal amplitude inside the cursor area. The position of the maximal amplitude is pointed by cross-lines. A-scan waveform corresponds to the horizontal position of the cross-lines.
		Type of cursor offers operator to manually specify position of cross-lines over b-scan. Horizontal and vertical lines are hidden in order to avoid obstruction of information shown on b-scan.
		Classical type of cursor with elongated vertical and horizontal cross-lines.
LED	-	Switches the device's laser pointers on/off
Sound daq	-	The app informs operator about finalizing daq by sound signal when switched on
Sound toolbar	-	If turned on, the app confirms parameter changes with sound signal.
Save screenshot	-	If turned on, the app saves a jpeg-screenshot with each measurement.
Depth	-	The depth parameter defines the required inspection depth. There are three options available: 1.25m, 2.5m and 3.5m. The smaller the inspection depth is, the faster is transmission speed over WiFi. If it is possible, reduce the depth to speed up the instrument in matrix mode.
Free space	-	See description below
Version	-	App release version

Free space

The value shows the amount of available internal memory. If there is less memory than 250MB, a warning message appears.

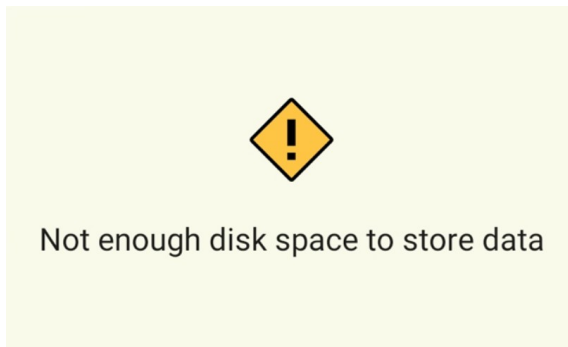

In this case the app allows measurements in B-Scan and C-Det modes but prohibits saving any B-Scan or C-Det data. Both measuring and saving of a MAP are not available.

23.1 Instrument configuration

After the app installation or re-installation, the operator must configure the instrument. The configuration is also necessary if the operator plans to change the configuration type between A1040 MIRA 3D and A1040 MIRA 3D PRO.

23.1.1 A1040 MIRA 3D

To configure A1040 MIRA 3D follow up the following steps.

Step 1

Switch on the tomograph, establish the connection to the hotspot and start the app. Refer to the details for the `getting started` procedure on [page 88](#).

Step 2

Open the `setup` mode and press button  to scan for online instruments.

Scanning process will be indicated with `progress bar` .

Step 3

After the scan finishes, the `device list` **1** shows all available devices. Select `<% INSTRUMENT%>-configuration` **2** and tap on a device item **3** to assign it as a master , Figure 20.

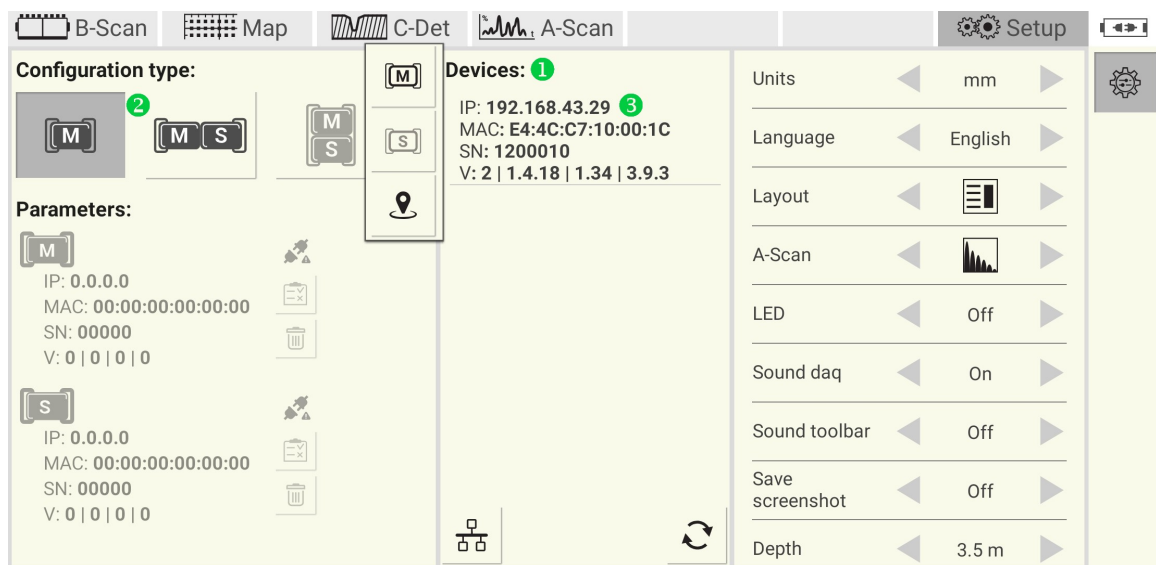







Figure 20: A1040 MIRA 3D configuration

NOTE

If the `device list` encounters more than one instruments use button  to distinguish one instrument from another.

Step 4

After successful connection the panel **1** shows parameters of the master device.

The indicator **2** changes from  to . The battery indicator **3** changes its status from disconnected  to power,  Figure 21.

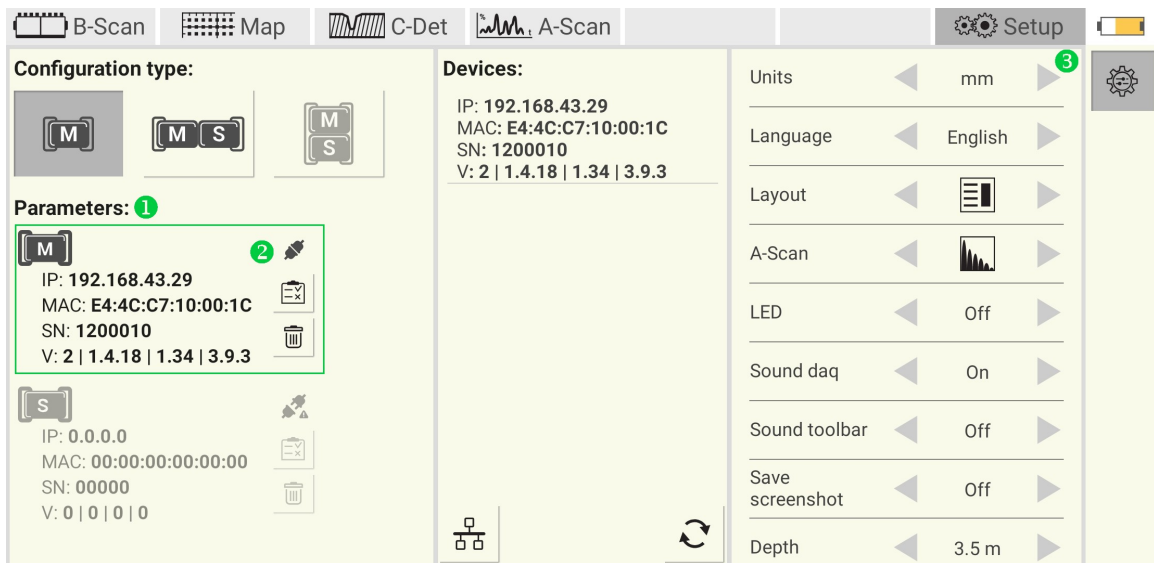

Figure 21: A1040 MIRA 3D connection

23.1.2 A1040 MIRA 3D PRO

The tomograph configuration follows the mechanical assembly described on [page 11](#).



WARNING

The master instrument feeds the synchronization signal to the slave over H-fasteners ①. The polarity of the wiring is of great importance. Keep in mind the master is always on the left if the keypad looks towards you, Figure 10

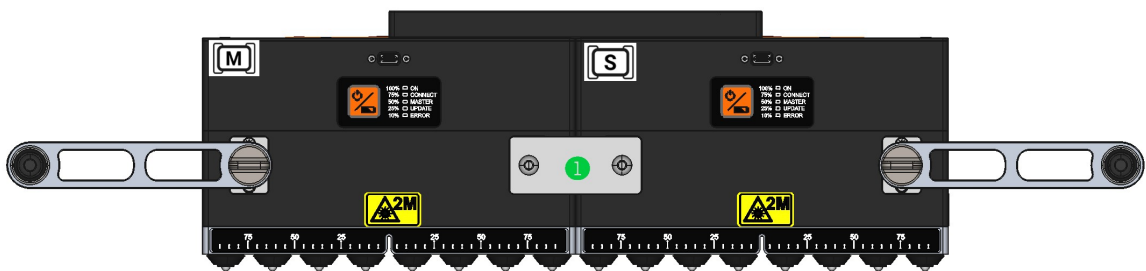

Figure 22: Master and slave synchronization



CAUTION

Before starting the configuration of the A1040 MIRA 3D PRO refer to the configuration details of A1040 MIRA 3D given on the [page 71](#).

A1040 MIRA 3D PRO configuration

Switch on the tomograph, establish the connection to the hotspot and start the app. After the scan finishes, the device list **1** shows all available devices. Select A1040 MIRA 3D PRO-configuration **2** and tap on a device item **3** or **4** to assign the device as a master **[M]** or as a slave **[S]**, Figure 23.

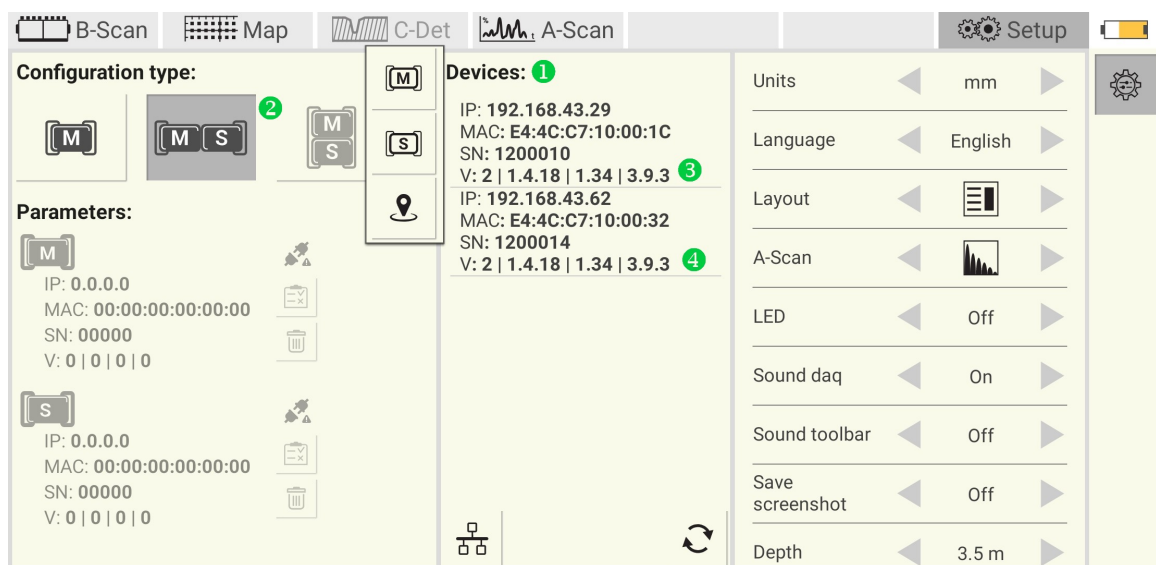





Figure 23: A1040 MIRA 3D PRO configuration

After successful connection the panel **1** shows parameters of the master and the slave devices. The indicator **2** changes from  to . The battery indicator **3** changes its status from disconnected  to power,  Figure 24.

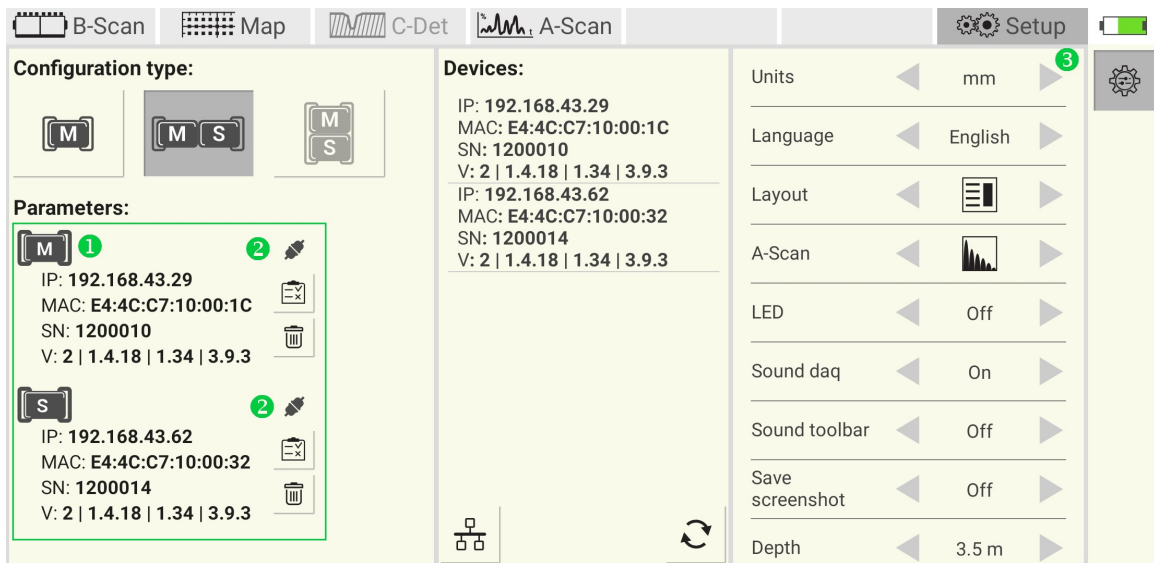

Figure 24: A1040 MIRA 3D PRO connection

23.2 Automatic transducer testing

The delivery kit includes a `test block`. The block is a plexiglass plate with a slightly rough surface. It is used to perform the functionality test of each array transducer.

23.2.1 A1040 MIRA 3D

This section describes the step-by-step procedure for transducer testing of A1040 MIRA 3D.

Step 1

Put the sample on a flat, dry and stable surface.

Step 2

Switch on the tomograph, establish the connection to the hotspot and start the app. Refer to the details for the `getting started` procedure on [page 88](#). Open `setup` mode and configure the instrument as master.

Step 3

Activate the `testing` procedure by pressing the  button. After activation the app shows the following window. Put the instrument on the sample and press it firmly.

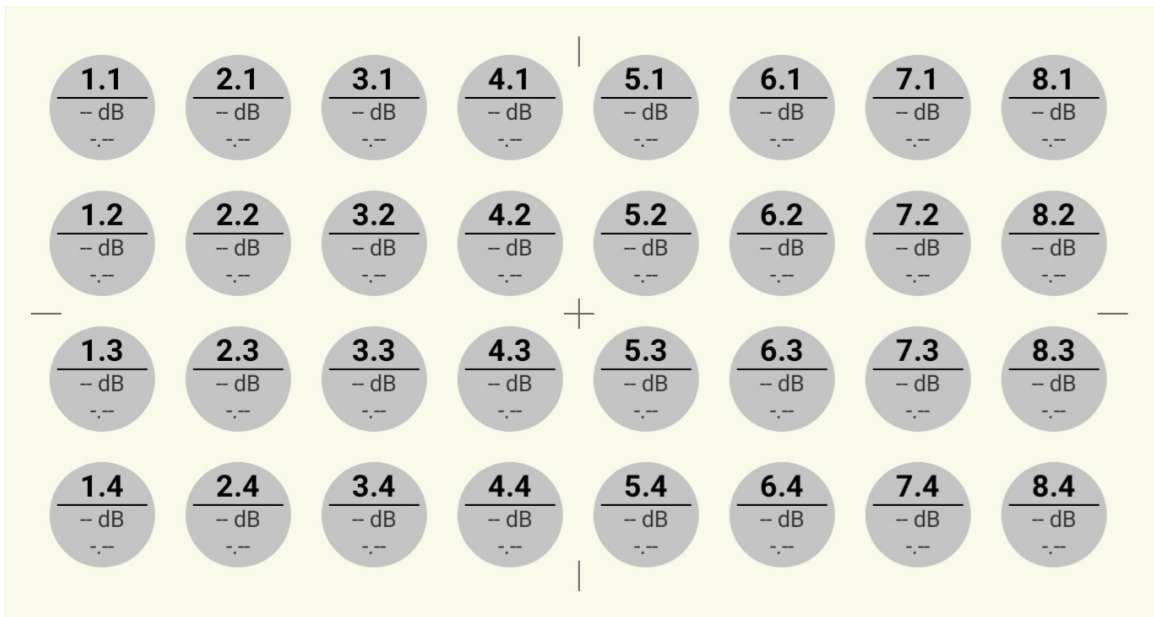

Step 4

Press any data collection button located at one of the handles of the tomograph. After pressing the button the tomograph starts scanning. The dialog looks as follows.

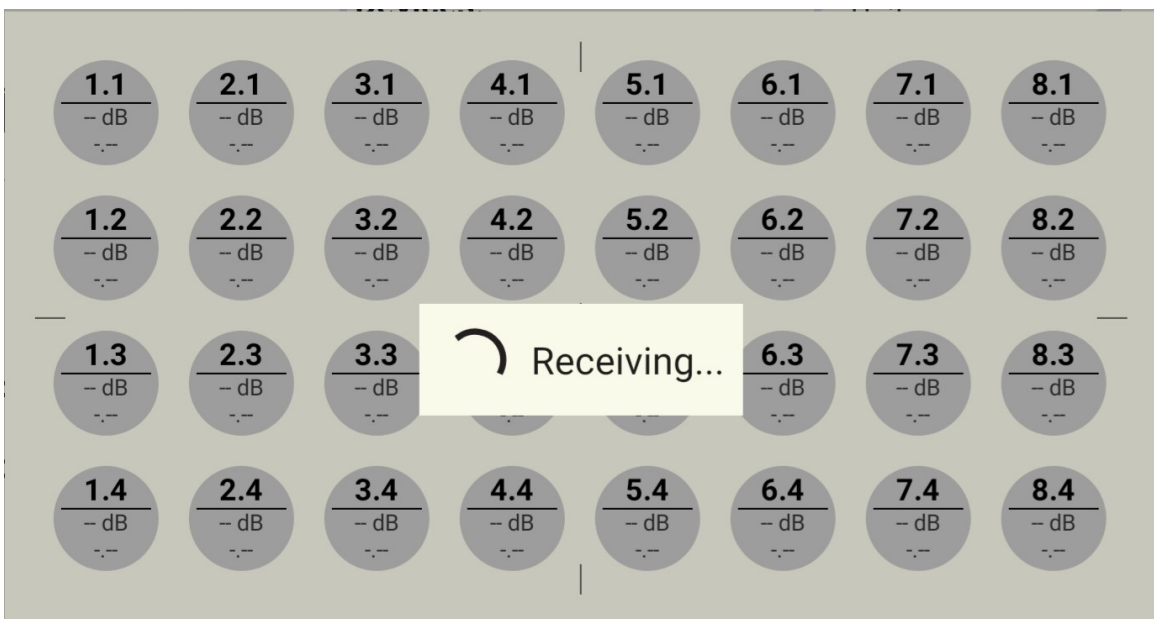

Step 5

In case of a successful test the transducers will be colored green. This means, that the tomograph is ready to use.

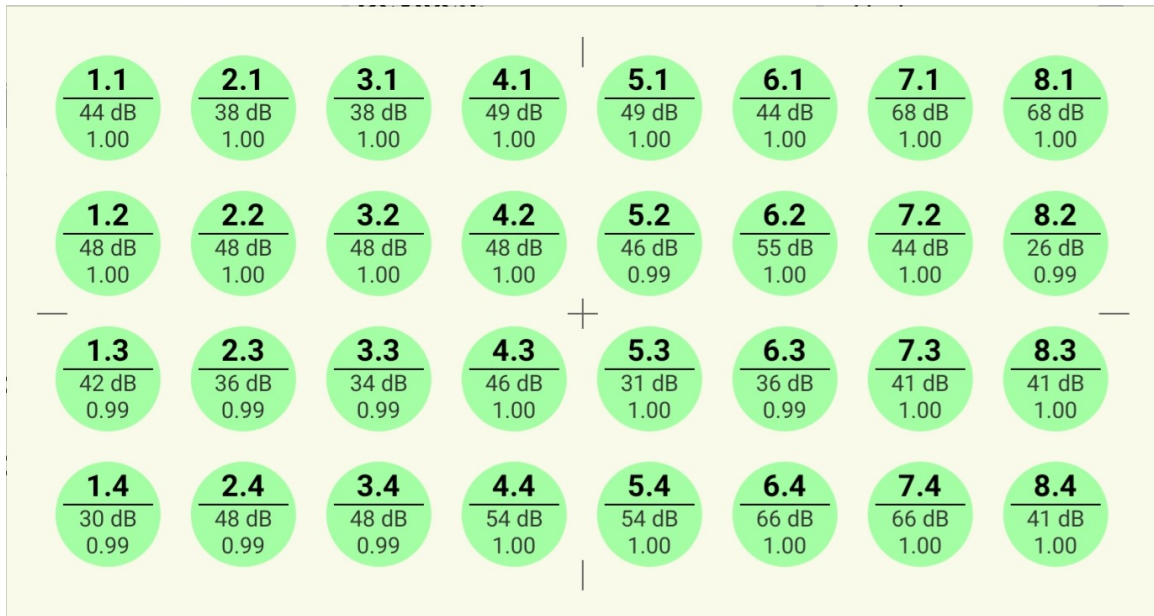

In case of an error a transducer will be colored red.



In this case it is necessary to contact the manufacturer service center by e-mail at info@acs-international.com or by phone: +49 681-9659-2270.

23.2.2 A1040 MIRA 3D PRO

NOTE













The transducer testing of the master and the slave of A1040 MIRA 3D PRO is independent. Carry out the procedure described on the [page](#)⁷⁵ to test the master and the slave. The A1040 MIRA 3D PRO is ready to work only if both the master and the slave passed the test.

24 Powering

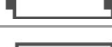

The app observes the battery state of the instrument and the Tablet-PC.

Charge level indicator

The `charge level indicator` at the right top of the screen shows the level of the battery charge and whether it is charging. The indicator takes one of the states represented by the following icons:

Symbol	Description
	remaining charge 100%
	remaining charge 90%
	remaining charge 80%
	remaining charge 70%
	remaining charge 60%
	remaining charge 50%
	remaining charge 40%
	remaining charge 30%
	remaining charge 20%
	remaining charge 10%
	instrument is not connected
	instrument is charging

NOTE

The indicator shows charge level of both the instrument and the Tablet-PC. The indicator changes the color between  (the instrument) and  (the Tablet-PC) every 5 seconds.

NOTE

A warning message appears if the charge level of the instrument or/and the Tablet-PC is less than 10%. The message pops up every 3 minutes:

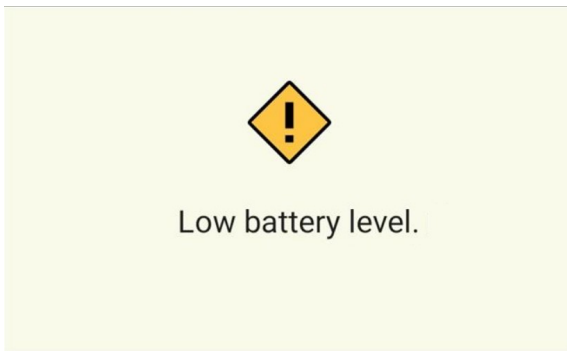

Charge level information window

Open the charge level information window by single taping on the charge level indicator.

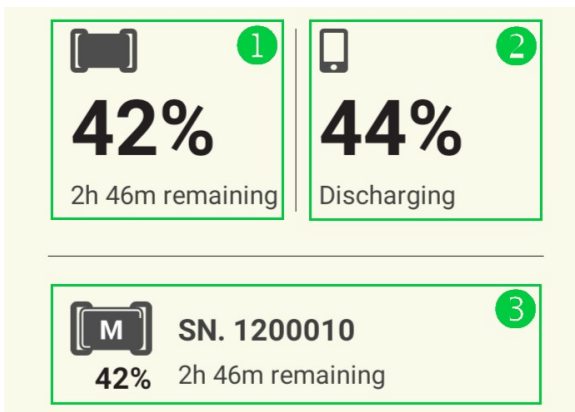

Label	Description
①	<p>Instrument section. It shows the remaining charge level of the instrument. The text field takes one of the following values:</p> <ul style="list-style-type: none"> • Xh Ym remaining - time to full discharging • Approx. Xh until fully charged - time to full charging • -h -m - waiting for condition information. It takes some time for the app to read the charge level from the instrument. You may see this text if you just established connection with the Tablet-PC, connected or disconnected charging cable. Wait for about 1 minute and try to open the window again.
②	<p>Table-PC section. It shows the remaining charge level of the Table-PC. The text field takes one of the following values:</p> <ul style="list-style-type: none"> • Discharging - discharging is in process • Charging (Ac) - charging over the power charger • Charging (Usb) - charging over USB interface
③	<p>Instrument section. This section shows the charge level state of the master and the slave. In the case of A1040 MIRA 3D, section ③ shows the same information as section ① (only the master is present). In the case of <% INSTRUMENT PRO%>, this section lists the charge levels of both the master and the slave. But section ① takes the worst charge level in respect to operation time.</p>

25 Connectivity

This chapter describes details on different connection types of A1040 MIRA 3D and A1040 MIRA 3D PRO.

25.1 WiFi Hotspot

The A1040 MIRA 3D and A1040 MIRA 3D PRO establish the connection with a Tablet-PC over WiFi Hotspot. The connection is successful if the parameters of the Tablet-PC WiFi Hotspot and the instrument are correct. This chapter describes the details on the parameters of the WiFi Hotspot connection.

Tablet-PC WiFi Hotspot

The WiFi Hotspot of the Tablet-PC has three main parameters given in the following table.

Parameter	Description
SSID/ Device name	Name of the WiFi Hotspot access point. The operator configures the name according to the following pattern: MIRA3D-XXXXXXX. For example, if the instrument's serial number is 1200010, then the WiFi Hotspot name must be MIRA3D-1200010.
Passw ord	The password is always 00000000
AP band	The frequency range of the WiFi Hotspot. Currently, the instrument supports only the 2.4GHz band.



CAUTION

The A1040 MIRA 3D PRO leaves the factory fully assembled and ready to work. Change parameters of the TABLET-PC WiFi Hotspot parameters only if it is being combined with another device (refer to the [page](#)⁹²).

A1040 MIRA 3D WiFi Hotspot, net.txt file

The A1040 MIRA 3D keeps its WiFi Hotspot parameters in the net.txt file. The operator can access the file as follows.

- Switch off the A1040 MIRA 3D
- Connect the USB cable to the PC TYPE A plug

- Press and hold the power button (). Within the next 2 seconds, connect the USB cable to the instrument TYPE C plug. The update indicator is on now. It confirms the device's readiness for the update.
- The PC detects A1040 MIRA 3D storage device. Please, open it in the file explorer.

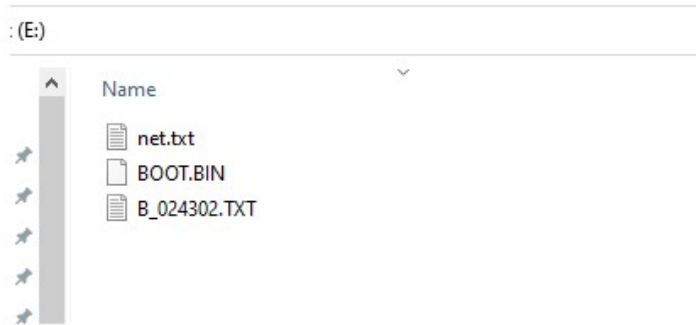

- Copy file net.txt to the PC and open it with a text file editor
- Change the value of the field AP_name= to the name of the Tablet-PC WiFi Hotspot. Delete the blanks after the name of the hotspot. Do not change other parameters.

NOTE

The AP_name must be the same as SSID of the Tablet-PC device

- Copy the updated file to the device. The update indicator starts blinking. Wait until the indicator is not blinking for 10 seconds. The whole procedure takes about 1 minute.
- Disconnect the A1040 MIRA 3D from the PC. The WiFi Hotspot parameters are updated now.
- Operate the instrument normally.

**WARNING**

The A1040 MIRA 3D leaves the factory fully assembled and ready to work. Change parameters of the A1040 MIRA 3D WiFi Hotspot parameters only if the instrument is being used in a combination. To read more about combinations, refer to the [page⁹²](#).

A1040 MIRA 3D PRO WiFi Hotspot, net.txt file

In the case of A1040 MIRA 3D PRO, the Tablet-PC operates with two instruments. These are the master and the slave, see [page 121](#). In that case, the name of the Tablet-PC WiFi Hotspot contains the serial number of the maser. The net.txt file of the master and the slave must refer to the same Tablet-PC Hotspot. Thus, if the serial of the master is XXXXXXXX, and the serial of the slave is YYYYYYYY, then:

- Table-PC WiFi Hotspot is MIRA3D-XXXXXXX
- File net.txt of the master has AP_name=XXXXXXX
- File net.txt of the slave has AP_name=XXXXXXX



WARNING

The A1040 MIRA 3D PRO leaves the factory fully assembled and ready to work. Change parameters of the A1040 MIRA 3D PRO WiFi Hotspot parameters only if the instrument is being used in a combination. To read more about combinations, refer to the [page 92](#).

NOTE

If you need to update the A1040 MIRA 3D PRO WiFi Hotspot name, use the A1040 MIRA 3D procedure for the master and the slave separately.

26 Getting started

26.1 App installation

This chapter describes the steps for Installation or reinstallation of A1040 MIRA 3D android application

Copying installation package

- Copy installation package a1040_mira_3d-app-X.X.XX.apk to "acs-solutions apps" tablet internal storage folder. The name of apk file contains X.X.XX symbols. There are placeholders for the package version.

Starting installation and setting permissions

- Start installation and confirm all the requested permissions
- Allow installation permission

Allow Files to install apps?

Downloading apps from external sources will put your device and personal data at greater risk. By touching ALLOW, you indicate that you accept these risks.

Don't ask me again

DENY

ALLOW

- Allow app permissions

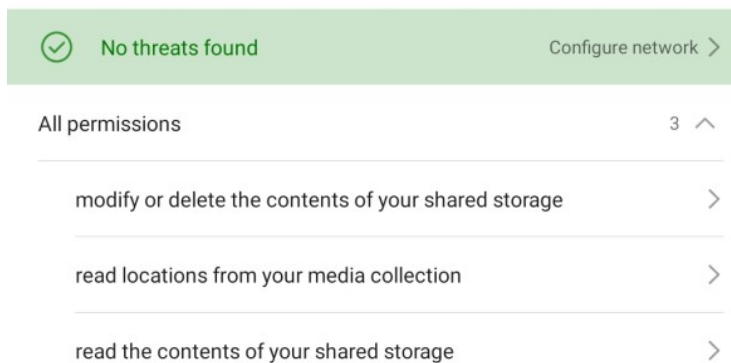

- Allow storage permissions

PERMISSIONS

Storage



26.2 App activation

If the app was installed for the first time, reinstalled or updated it must be activated with a license key. A step-by-step activation procedure is listed below.

Activation procedure

- Establish internet connection before starting the app. For internet access one can use either a SIM-card or WLAN.
- Start the app by tapping on the application icon. The welcome screen presented below appears immediately after start. The app initializes tablet resources as long as the screen is shown. After initialization is finished the activation dialog starts.

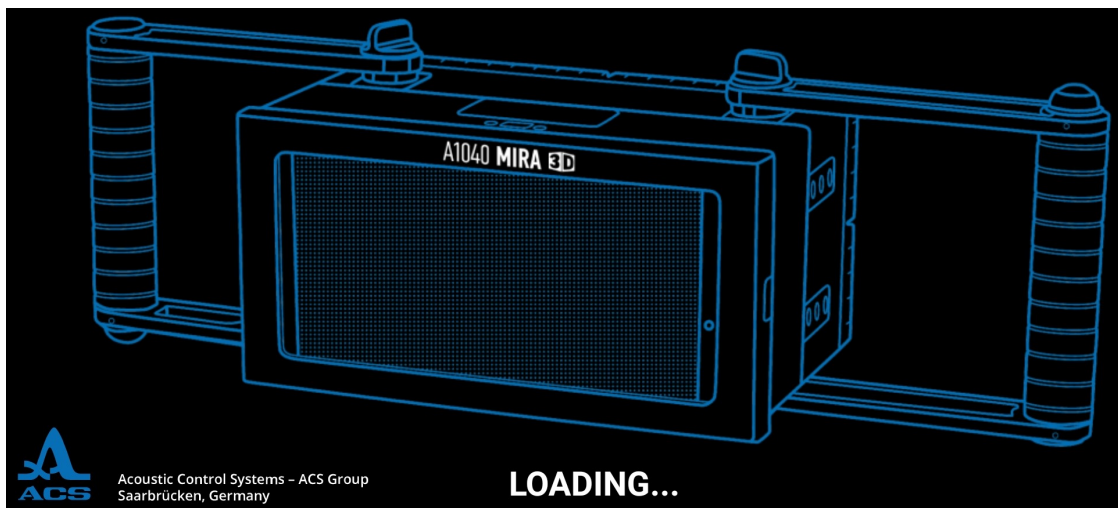

- Enter a license key in the activation dialog and press "ICON". The typing errors while entering the license key can be corrected by using keyboard. The app will be trying to verify the license by sending request to the license server. In case of successful verification activation dialog will be closed and notification dialog will be opened.

Enter key and activate your app

1	2	3	4	5	6	7	8	9	0	↩
Q	W	E	R	T	Y	U	I	O	P	Del
A	S	D	F	G	H	J	K	L	Ins	
Z	X	C	V	B	N	M	◀	▶		

- Notification dialog reminds the operator to switch on a personal hotspot.

License status  and update status  are also presented in this dialog. The dialog can be closed by single tap.

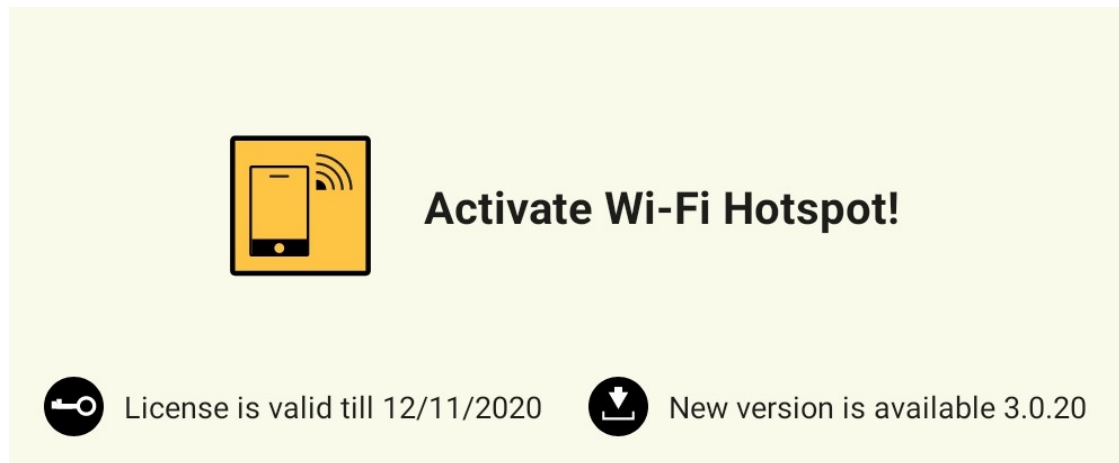

Errors during activation

There is a number of reasons the activation of the app can not be finished: lack of internet connection, license server error, not existing license key or expiration of the license. In case of an error the activation dialog will be extended with one of the following messages:

- Establish internet connection to activate the app
- License server is not available, contact the support
- License expired, contact the support
- License does not exist, contact the support

An example of failed activation is shown below. If you are not able to finish activation press  and contact support.

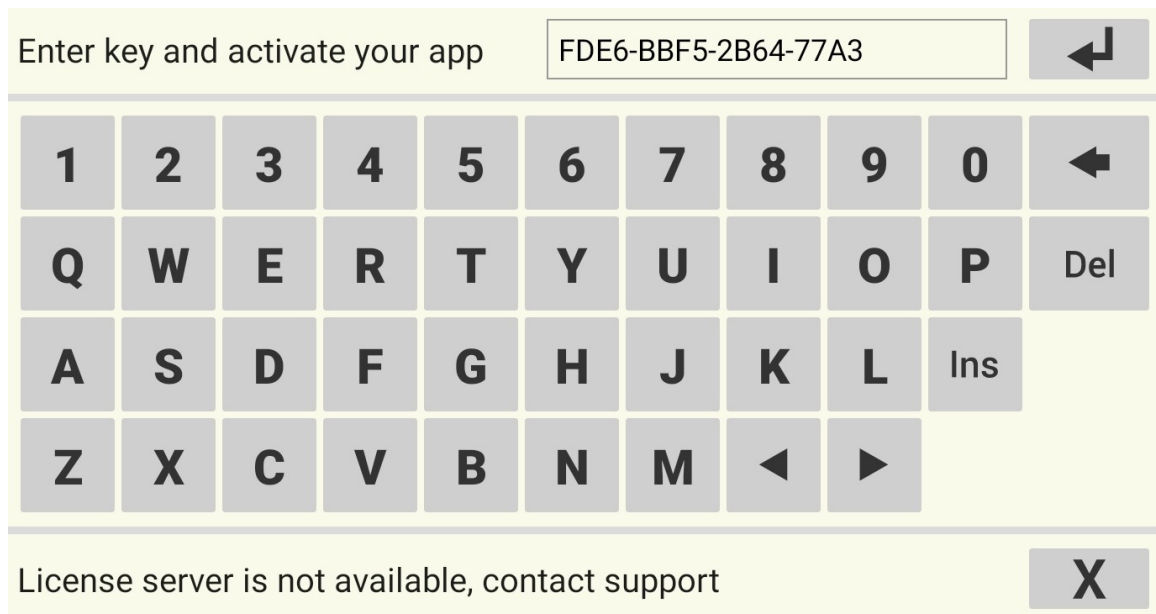

26.3 Preparation for work

In order to start or finish work with the tomograph some preparation steps are required. The description of these steps can be found in this chapter.

Switching on the tomograph

- Press and hold the button power up/down for at least 3 seconds. LED "ON" starts blinking. During that time the operation system of the instrument is being loaded. Finishing of the loading process is indicated by changed state of "ON". The LED lights constantly.

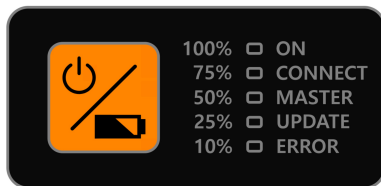

- The tomograph is now ready to establish the connection to hotspot, LED "CONNECT" is blinking.

Starting the app

- Before launching the app you need to switch on the hotspot. It can be done by swiping at the upper part of the table screen to call quick start menu. In the menu activate the hotspot as shown below.

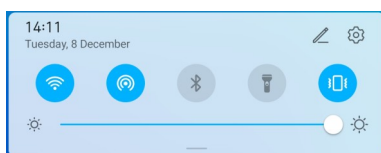

- Successful connection of the tomograph to the hotspot will be indicated by the little number [1] next to the hotspot icon, see the following image.



- Launch the app and create a new configuration as it is described in [Setup](#) chapter. Finalize the configuration and connect to the instrument. If the configuration has already been created, the app will try to establish connection with the tomograph automatically. If the connection was successfully established, LED "CONNECT" starts glowing constantly. The tomograph is ready to work.

Closing the app

The operator can close the A14040 MIRA 3D app using standard approach.

Switch off the tomograph

- The tomograph can be switched off by pressing and holding the power button for 3 seconds. The switching off procedure discharges all capacitors inside of the tomograph in order to get rid of residual voltage. While discharging all the LEDs are simultaneously blinking.
- In rare case the tomograph is hanging in such a way that operation system does not respond. In this case, press and hold the power button for 10 seconds.

26.4 Update

The system update includes both renewals of the micro-controller firmware and the app. There are two ways to update the app: the *Automatic* or *Manual* update. During the *Automatic* update the app updates itself if an internet connection and the license server are available. If the internet connection or license server is not available the app can be updated manually.

Automatic update

- The notification dialog informs the operator about a new available app version on the license server.

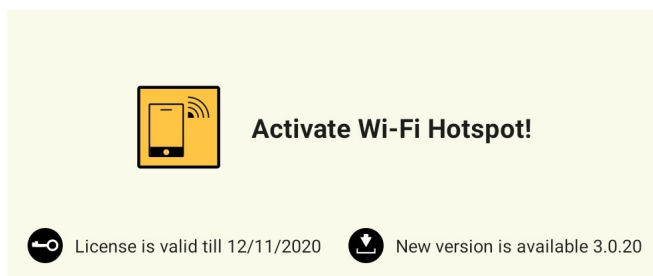

- Force the update by pressing the  button in setup mode:

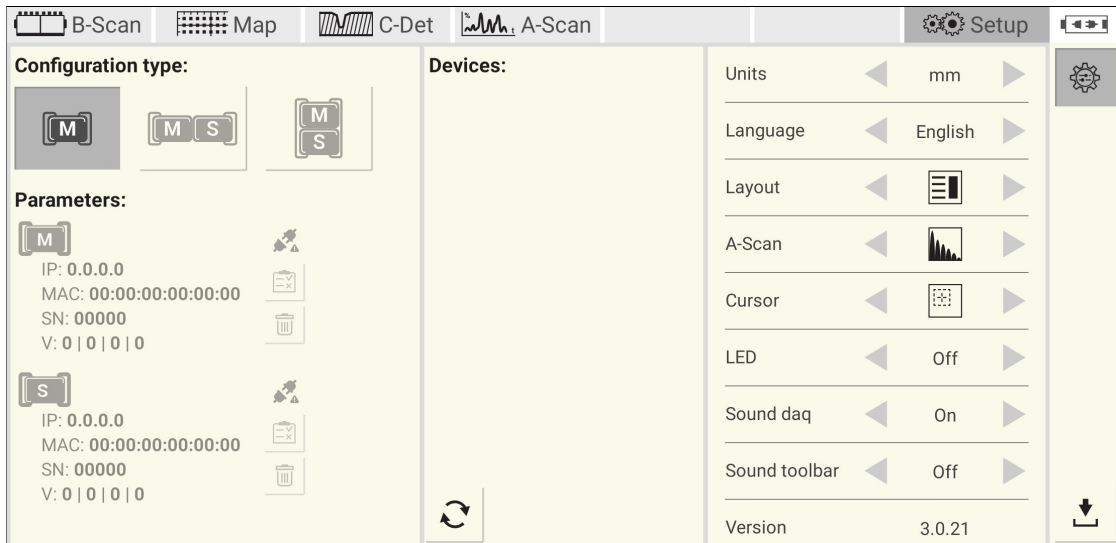

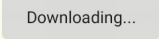
- Wait until the app will be downloaded from the server. The downloading process is accompanied by the progress dialog 
- After downloading is completed wait until the installation process is started. The installation of the update is similar to the app installation described in the chapter Getting started at [page 85](#). The new app version will be activated automatically by taking the license key from the previous installation.

Manual update

The manual update to be done in as follows:

- Download the installation package from A1040 MIRA 3D homepage
- Follow up steps described at [page 85](#) including app installation and activation.

Firmware update

The A1040 MIRA 3D app informs the operator about the necessity of the firmware update. The update to be performed as follows:

- Switch off the A1040 MIRA 3D
- Download the latest firmware from A1040 MIRA 3D home page
- Connect the USB cable to the Windows PC TYPE A plug
- Press and hold the power button () . Within the next 2 seconds, connect the USB cable to the instrument TYPE C plug. The update indicator is on now. It confirms the device's readiness for the update.
- Windows PC detects the A1040 MIRA 3D storage device. Please, open it in the file explorer.

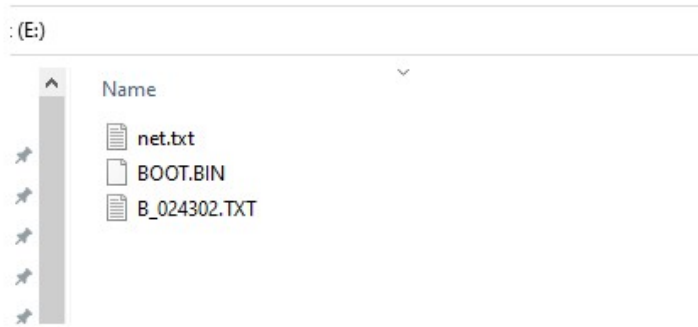

- Delete following files: `BOOT.BIN` and `B_?????.TXT`
- Copy the new firmware file to the storage. The update indicator is blinking while the firmware file is being copied. Wait until the update indicator stops blinking.
- Disconnect the `A1040 MIRA 3D` from the PC. The instrument is updated now.
- Start the instrument, connect the device to the app, and finally, check the firmware version in the setup mode.

27 Licensing

The application software works with a unique licensing key. The licensing key contains information about the features, functions and serial numbers of the electronic blocks. The licensing key does not allow the application to work with an electronic block with the unknown serial number. Not-activated features and functions will not be available in the application as well.

Licensing key

The user of A1040 MIRA 3D finds the licenses key in the warranty certificate as shown bellow:

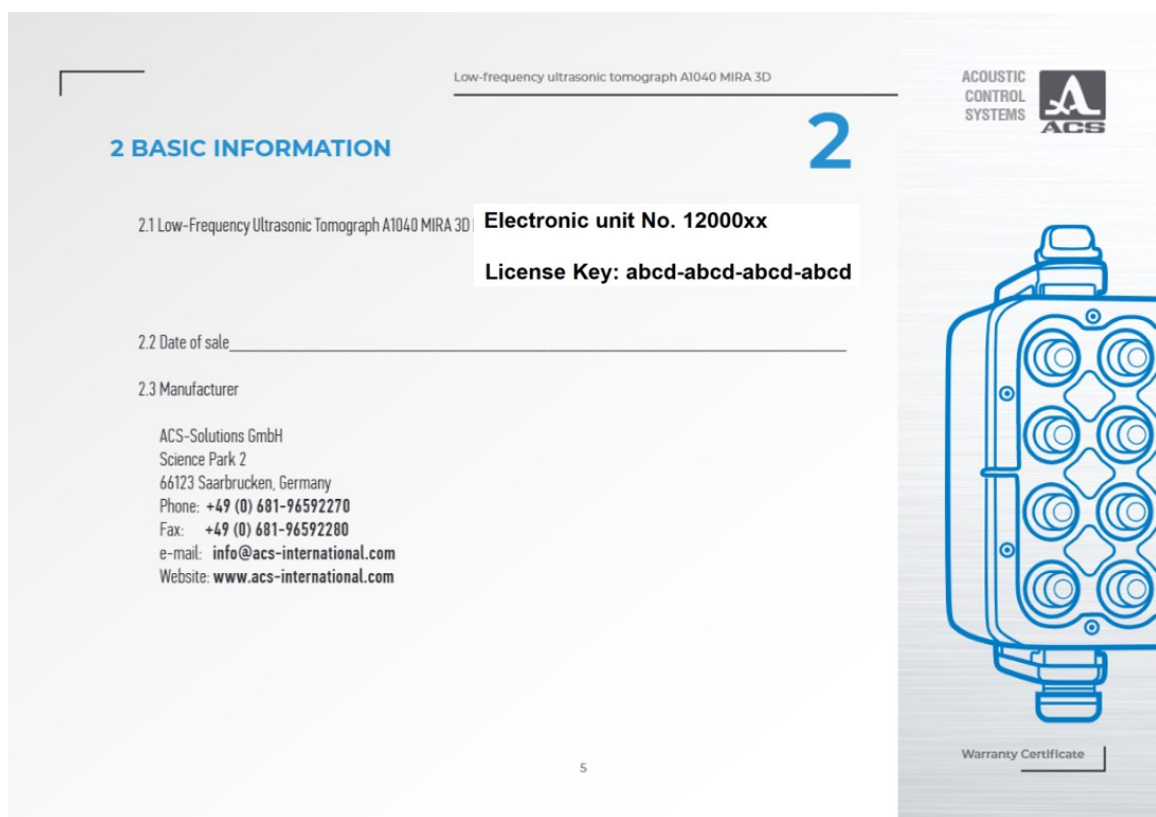

The user of A1040 MIRA 3D PRO finds the licensing key here:

Low-frequency ultrasonic tomograph A1040 MIRA 3D PRO

2 BASIC INFORMATION

2.1. Low-Frequency Ultrasonic Tomograph A1040 MIRA 3D PRO contains two electronic units with the serial numbers.

Electronic unit No. 12000xx
Electronic unit No. 12000xx

License Key: abcd-abcd-abcd-abcd

2.2 Date of sale _____

2.3 Manufacturer

ACS-Solutions GmbH
Science Park 2
66123 Saarbrücken, Germany
Phone: +49 (0) 681-96592270
Fax: +49 (0) 681-96592280
e-mail: info@acs-international.com
Website: www.acs-international.com

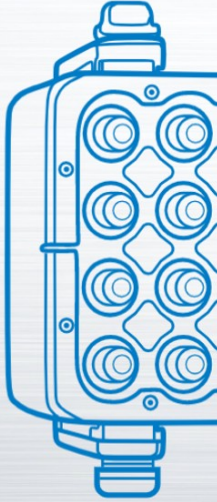
Warranty Certificate _____

5

Combinations

The operator can link or unlink electronic units of different A1040 MIRA 3D and A1040 MIRA 3D PRO tomographs to achieve different measurement goals. The A1040 MIRA 3D A can operate in the following combinations with any A1040 MIRA 3D B or any A1040 MIRA 3D PRO C D:

Combination list	License
[A B]	with license [A] or with license [B]
[B A]	with license [A] or with license [B]
[A C]	with license [A] or with license [C D]
[C A]	with license [A] or with license [C D]
[A D]	only with license [A] since [D] is a secondary unit of A1040 MIRA 3D PRO
[D A]	only with license [A] since [D] is a secondary unit of A1040 MIRA 3D PRO

The A1040 MIRA 3D PRO [A B] allows following combinations with any A1040 MIRA 3D PRO [C D]:

Combination list	License
[A C]	with license [A B] or with license [C D]
[C A]	with license [A B] or with license [C D]
[A D]	only with license [A B] since [D] is a secondary unit of A1040 MIRA 3D PRO
[D A]	only with license [A B] since [D] is a secondary unit of A1040 MIRA 3D PRO
[C B]	only with license [C D] since [B] is a secondary unit of A1040 MIRA 3D PRO
[B C]	only with license [C D] since [B] is a secondary unit of A1040 MIRA 3D PRO



CAUTION

The secondary unit [B] of any A1040 MIRA 3D PRO [A B] tomograph can not operate as stand-alone A1040 MIRA 3D.

28 File format

The file format of A1040 MIRA 3D and A1040 MIRA 3D PRO is open for any user. This chapter describes user parameters, reading procedures and saving principles.

28.1 File list

The application saves the data relevant to the measurement in several files placed in the folder named by the user during the save procedure. For different measurement modes the file structure differs.

File/Folder	Description
reporting	The folder contains all files and configurations which are relevant to the report. Find the report in <code>report.pdf</code> file.
config.m3d	main configuration file in JSON format
params.txt	b-scan parameters in ASCII format
raw_data.bin	binary file with raw measured data
soft_data.bin	binary files with reconstructed data
vel_data.bin	This is a binary file with raw velocity data. The application uses this data to estimate the sound velocity.

File params.txt

The application exports the relevant parameters in human-readable ASCII format into a `params.txt` file. Refer to the following table for a detailed description.

Parameter	Description
version : 1.1	The file format may evolve with time. Read the <code>version</code> first. Then adjust your reading routine for that parameter.
analog gain [dB] : 10	refer to page 47
operating frequency [kHz] : 50	refer to page 47
period count : 1.0	refer to page 47
tgc [dB/mus] : 0.00	refer to page 47

tgc delay [mus] : 0	refer to page ^[47]
material velocity [m/s] : 2600	refer to page ^[47]
dpy delay [mus] : 35	DPY-delay in μ s
filter bandwidth [kHz] : 25	refer to page ^[47]
sw compensation : true	refer to page ^[47]
compute velocity : true	refer to page ^[47]
image smoothing : medium	refer to page ^[47]
color gain [dB] : 15	refer to page ^[47]
frame width [pt] : 928	width of the b-scan in pixels
frame height [pt] : 416	height of the b-scan in pixels
frame count : 21	number of b-scans for <code>array mode = matrix</code>
frame step [mm] : 5.0	distance between b-scan for <code>array mode = matrix</code>
frame left [mm] : - 1116.00	left border of the b-scan in mm
frame right [mm] : 1115.00	right border of the b-scan
frame top [mm] : 0.00	upper border of the b-scan
frame bottom [mm] : 1000.00	lower border of the b-scan
computed velocity [m/s] : 2860	estimated sound velocity
computed delay [smp] : 30	DPY-delay in samples
(1,1) computed velocity [m/s] : 1370	Estimated sound velocity for a map position (X,Y), refer to page ^[98] . This parameter exists only in the <code>map</code> mode.
(1,1) computed delay [smp] : 35	DPY-delay in samples for a map position (X,Y), refer to page ^[98] . This parameter exists only in the <code>map</code> mode.

File `raw_data.bin`

The procedure for reading of `raw_data.bin` depends on `array mode` [parameter](#)^[88] (`linear` or `matrix`) and instrument configuration [type](#)^[68]. Use the following `matlab` code for reading:

```
clear all;
```

```

fpath = '../raw_data.bin'; %define file path
finfo = dir(fpath);
filesize = finfo.bytes; %get files size in bytes
fid = fopen(fpath, 'r', 'l');
bscan = fread(fid, 'int16');
fclose(fid);
if(filesize == 4096 * 28 * 2) %array mode = linear,
instrument configuration = A1040 MIRA 3D
    a1040_mira3d_bscan_linear = reshape(bscan,4096,28)';
%read and reshape 28 vectors
elseif(filesize == 4096 * 496 * 2) %array mode = matrix,
instrument configuration = A1040 MIRA 3D
    a1040_mira3d_bscan_matrix = reshape(bscan,4096,496)';
%read and reshape 496 vectors
elseif(filesize == 4096 * 120 * 2) %array mode = linear,
instrument configuration = A1040 MIRA 3D PRO
    a1040_mira3d_pro_bscan_liner =
reshape(bscan,4096,120)'; %read and reshape 120 vectors
elseif(filesize == 4096 * 2016 * 2) %array mode = matrix,
instrument configuration = A1040 MIRA 3D PRO
    a1040_mira3d_pro_bscan_matrix =
reshape(bscan,4096,2016)'; %read and reshape 2106 vectors
end

```

File `saft_data.bin`

The size of reconstructed data depends on the `array mode` parameter. In the case of `array mode = linear`, the file includes one reconstructed b-scan (or one slice). However for `array mode = matrix` the file contains several b-scans. These b-scans form a resulting volume. Use the following `matlab` code for reading:

```

clear all;
param.frame_width = 928;
param.frame_height = 416;
fpath = '../saft_data.bin';
finfo = dir(fpath);
filesize = finfo.bytes; %get files size in bytes
fid = fopen(fpath, 'r', 'l');
bscan = fread(fid, 'single');
fclose(fid);
if(filesize == param.frame_width * param.frame_height *
4)
%array mode = linear, instrument configuration = A1040
MIRA 3D / A1040 MIRA 3D PRO
    T =
reshape(bscan,param.frame_width,param.frame_height); %
read b-scan
else %array mode = matrix, instrument configuration =
A1040 MIRA 3D / A1040 MIRA 3D PRO

```

```

    n = filesize/
    (param.frame_width*param.frame_height)/4; %read b-scan
    T =
    reshape(bscan,param.frame_width,param.frame_height,n);
end

```

NOTE

Read `frame_width` and `frame_height` parameters values from `param.txt`

File `vel_data.bin`

The size of the velocity data depends on `array mode` parameter. Read the `vel_data.bin` using the following code:

```

clear all;
fpath = '../vel_data.bin'; %define file path
finfo = dir(fpath);
filesize = finfo.bytes; %get files size in bytes
fid = fopen(fpath, 'r', 'l');
bscan = fread(fid, 'int16');
fclose(fid);
if(filesize == 4096 * 28 * 2) %array mode =
linear/matrix, instrument configuration = A1040 MIRA 3D
    a1040_mira3d_bscan_linear = reshape(bscan,4096,28)';
%read and reshape 28 vectors
elseif(filesize == 4096 * 120 * 2) %array mode =
linear/matrix, instrument configuration = A1040 MIRA 3D
PRO
    a1040_mira3d_pro_bscan_liner =
    reshape(bscan,4096,120)'; %read and reshape 120 vectors
end

```

28.2 Modes

B-Scan mode

For the data measured in `b-scan` mode the saved data folder contains the files described on [page 95](#).

C-Det mode

The file structure of a measurement in `c-det` mode is the same as for `b-scan` mode.

MAP mode

The data saved for a map mode measurement has slightly different file structure. It contains `reporting` folder, `config.m3d`, `params.txt` files and several subfolders named in `X_Y` format, where `X = 1,2,...` and `Y = 1,2,...`. Each `X_Y` subfolder contains `raw_data.bin`, `soft_data.bin` and `vel_data.bin` files, which are raw, reconstructed and velocity data for the corresponding map position.

NOTE

In the map mode the file `params.txt` contains estimated sound velocity and DPY-dealy for each map position. These entries start from (X, Y) .
