

ULTRASONIC
FLAW DETECTOR



A1220 MONOLITH

OPERATION MANUAL



Acoustic Control Systems – Solutions GmbH
Saarbrücken 2018



7952 Nieman Road, Lenexa, KS 66214-1560 USA
Phone: 913-685-0675, Fax: 913-685-1125
www.ndtsupply.com, sales@ndtsupply.com

CONTENTS

1 DESCRIPTION AND OPERATION.....	6
1.1 Intended use.....	6
1.2 Technical specifications.....	6
1.3 Design and operation.....	8
2 INTENDED USE.....	15
2.1 Operating limitations.....	15
2.2 Preparing the device for use.....	15
3 OPERATING MODES OF THE DEVICE	17
3.1 ADJUSTMENT mode.....	12
3.2 The A SCAN mode (the echo method)	35
3.3 A SCAN mode (propagation method).....	41
3.4 MAP mode	42
3.5 STOP mode	44
3.6 Work with previously saved frames.....	45



4 MAINTENANCE	47
4.1 Power supply and power consumption	47
4.2 Maintenance frequency.....	47
4.3 Potential problems.....	47
4.4 Storage	47
5 TRANSPORTATION	48
APPENDIX A (references) Recommended literature on ultrasonic testing	49

The present operation manual (hereinafter referred to as “Manual”) contains technical specifications, description of the device and its operating principle as well as information necessary for the correct operation of the ultrasonic flow detector AI220 MONOLITH (hereinafter referred to as “flaw detector” or “device”).

Prior to start working with the device, please carefully read the manual.

Only properly trained personnel familiar with general principles of the theory of ultrasonic vibrations distribution and the present operation manual is allowed to operate the device.

For proper ultrasonic testing it is necessary to determine control objectives, choose control schemes, select transducers, assess control conditions for such materials etc.

The manufacturer continuously improves the possibilities of the device, its reliability and comfort of operation. This may result in some minor changes, not given in the present manual. These changes do not affect the technical specifications of the device.

The device is manufactured by:

ACS-Solutions GmbH
Science Park 2
66123 Saarbrücken, Germany

Phone: +49 (0) 681-96592270
Fax: +49 (0) 681-96592280
E-mail: info@acs-international.com
Website: www.acs-international.com

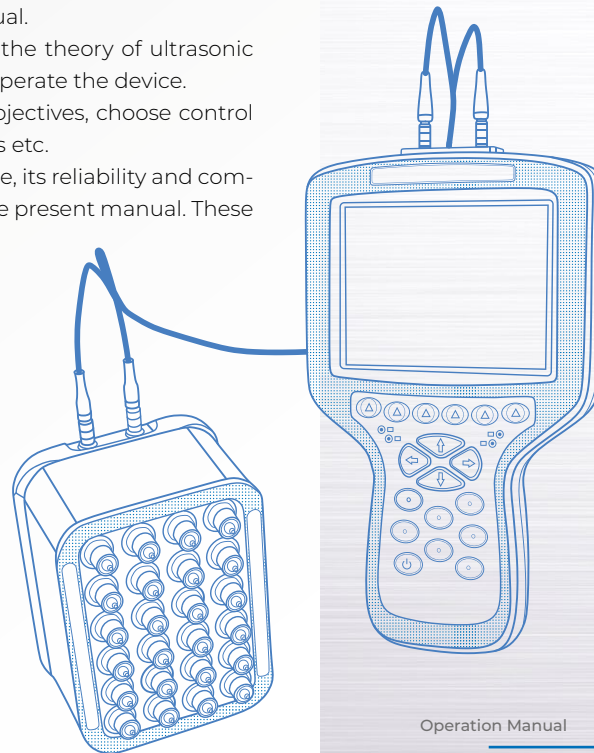



1

DESCRIPTION AND OPERATION

1.1 THE INTENDED USE

1.1.1 Area of application

The flaw detector A1220 MONOLITH is a portable ultrasonic device of general purpose.

The flaw detector is used for searching of foreign inclusions, cavities and cracks in products and constructions made of reinforced concrete, stone, plastics and similar materials in case of one-sided access to a control object, measurement of the thickness of concrete, examination of internal structure of coarse materials.

1.1.2 Operating conditions

The device is intended for operation under the following conditions:

- Temperature from - 30°C to + 55°C;
- Relative air humidity up to 95% at maximal temperature + 35°C

1.2 Technical specifications

1.2.1 Main parameters of the device

Main parameters of the device are given in the Table 1.

Table 1

Parameter	Value
Measurement range of the thickness at ultrasonic sound speed 2500 m/s (concrete), mm	from 100 to 2150
Limits of permissible absolute measurement error of the thickness at the ultrasonic sound speed 2500 m/s (concrete), mm, max., where X is the measured thickness in mm	$\pm(0.1 \cdot X + 5.0)$

Table 1

Parameter	Value
Measurement range of the defect depth at the ultrasonic sound speed 2500 m/s (concrete), mm	from 100 to 2150
Limits of the permissible absolute error of measurement of the defect depth at the ultrasonic sound speed 2500 m/s (concrete), mm, no more than, where X is a measured thickness in mm	$\pm(0.1 \cdot X + 5.0)$
Range of the specified ultrasonic sound speed, m/s	from 500 to 15,000
Form of a pulse	Rectangular, meander, 0.5 to 5.0 periods
Operating frequency of transducers, kHz	from 25 to 250
Adjustment range of calibrated amplifiers, dB	from 0 to 100
Number of average received signals	1; 2; 4; 8; 16; 32; 64; 128
Number of programmable points of time corrected gain characteristics	32
Adjustment limits of penetration delay, μ s	from 0 to 100
Power supply	Accumulator
Battery rated voltage, V	11.2
Period of continuous operation when battery powered under normal weather conditions, h, max.	8
Battery charging time, h	3
Overall dimensions of the electronic unit, mm	260×156×43
Weight of the electronic unit, kg, max.	0.8
Mean time between failures, h	30,000
Mean service life, years, min.	8

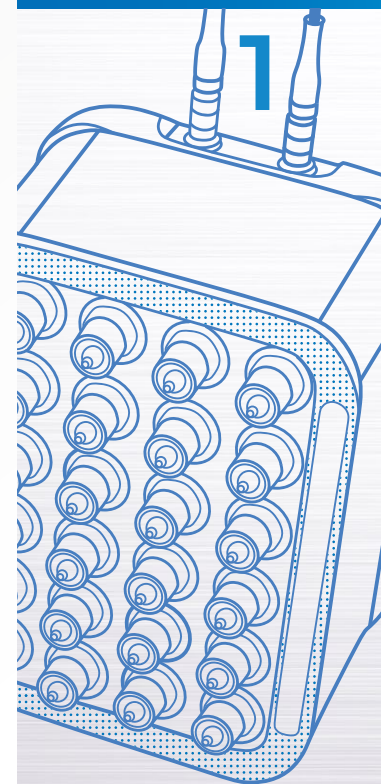

1.3 DESIGN AND OPERATION

1.3.1 Design

The flaw detector includes an electronic unit with a built-in battery to which the matrix antenna array is connected via cables. The device operating principle is similar to a dual element transducer (Figure 1) or an ultrasonic piezoelectric transducer with dry point or liquid contact (not included in the scope of delivery).

1.3.1.1 Electronic unit

The electronic unit forms electronic pulses, which actuate a matrix antenna array or a piezoelectric transducer, amplifies the signals received from piezoelectric transducers. The signals are then processed and visualized. The measurement results are represented in a digital form, the data are saved to a non-volatile memory and can be transmitted to an external PC.

The device is controlled using a membrane keyboard. The indication of signals, measurement results, the device state is performed on the display and by LED lights on the device body.

The matrix antenna array or piezoelectric transducer are connected using coaxial cables (included in the scope of delivery) through LEMO connectors which are located on the upper end of the body.

The device is powered by a built-in battery or a power adapter (included in the scope of delivery) connected to the socket on the bottom of the body. There is also a USB Micro B connector which is used for connection of a USB communication cable with a PC on the bottom of the body. Both connectors are closed with plugs.

WARNING: CHARGING OF THE DEVICE AND ITS SIMULTANEOUS CONNECTION TO A PC IS PROHIBITED!



Figure 1

1.3.1.2 Power adapter

The power adapter is used to supply the device from an external power source and to charge the battery from the mains (15 V).

Depending on the discharge degree, the battery charging may last up to 3 hours. When charged the flaw detector and all its functions may be normally used.

To avoid damage of the device, you should connect the power adapter cable to the electronic unit at first, connect the network cable to the power adapter and then connect the network cable to the mains.

1.3.1.3 Antenna array

The scope of delivery includes an M2502 0.05A0R100X60PS antenna array manufactured by "ACS".

M2502 0.05A0R100X60PS is a cophased antenna array with dry point contacts and with a group switching of elements operating at transverse ultrasonic waves.

The antenna array is connected via a dual LEMO-LEMO cable. The connector marked with a red dot is used for connection of the transmitting piezoelectric element, the unmarked connector is a receiving element (Figure 2).

1.3.2 Basic interface principles

The intuitive interface is used in the device. Associative menus with icons in various modes, the names and schematic designation of buttons ensure an easily and quick familiarization with the device.

The data displayed always include information necessary to monitor the device operation.

The configuration library may significantly facilitate working with the device. The user may assign a unique name to every configuration. Thus, the user may adjust the device for different conditions and testing objects in advance and just choose the necessary configuration from the list onsite.

All settings of the device are saved after the device is switched off and when the battery is charged.

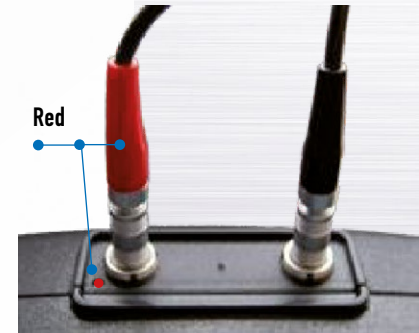







Figure 2

1.3.3 Operating modes

There are two operating modes in the flaw detector: A SCAN and MAP, STOP mode, as well the auxiliary mode ADJUSTMENT. In these operating modes the device forms testing pulses, amplifies received echo-signals, displays them and makes measurements.

Switching between the modes A SCAN and MAP is performed with the  button. To choose a mode, please:

- press the  button, until the operating mode selection window opens;
- choose the operating mode with   buttons in the open window (Figure 3);
- confirm the choice press the  button, to cancel it press the  button.

The A SCAN mode is used to generate and monitor the short-term pulse ultrasonic signals in a schematic form:

- in real time (echo testing method);
- with averaging of realization (direct testing method).

The MAP mode is used to form an image pattern of the tested object sections perpendicular to the tested object surface when scanning of the antenna array along the previously marked lines (rows) with a constant pitch.

The STOP mode is activated with the  button.

The STOP mode is used to stop (freeze) the realization of signals (frames) on the display in the A SCAN mode, to save them in the device memory and to review the previously saved frames.

You may switch to the ADJUSTMENT mode in any operating mode using the  button.

In the ADJUSTMENT mode you may select and change the settings of the device. Please always start to work with a new testing object in this mode.



Figure 3

1.3.4 Display

A colour TFT display with the 640x480 resolution is used in the device.

In every mode the screen is divided into several functional areas. The screen layout in the A SCAN mode is given in the Figure 4.

Figure 4

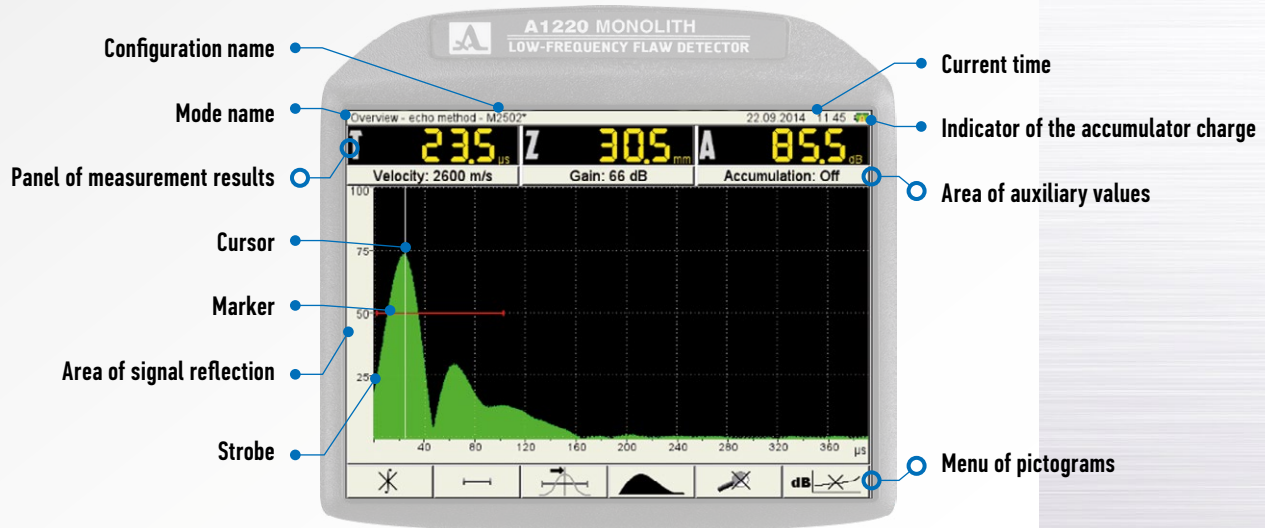

1.3.5 Keyboard

The keyboard of the device is given in the Figure 5.

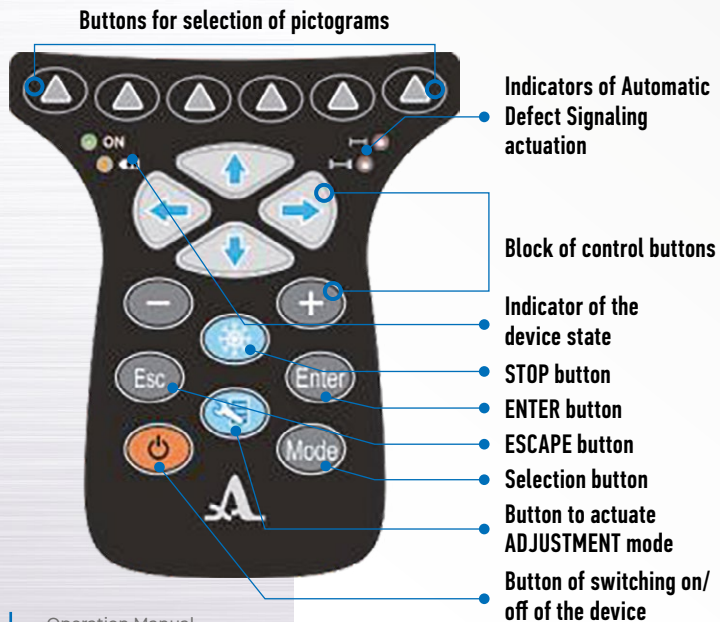

1

Figure 5



The green LED in the left top corner  ON shows that the flaw detector is on.

The LED indicator located below  shows the battery charge. The yellow colour indicates the battery charging process, the green colour indicates the charging is complete.

Two red LEDs in the right top corner show that the Automatic Defect Signaling is actuated for the first  and the second strobe  accordingly.

The buttons are marked with symbols meaning their primary functions. The english designation of the buttons is chosen to provide the standard uniform appearance of the device and to simplify the work with operational documentation during its use.











The main functions and parameters are controlled using the functional buttons (F) located under the screen, each button always has the corresponding explanatory icon above it.

The active parameters are chosen and changed using control buttons. Their functions are similar for various operating modes of the device and meant for intuitive learning by the operator, i.e. symbols on these buttons correspond to the character of the action performed.

For some buttons the auto-repeat mode with acceleration is provided. To switch to the mode hold the button for more than one second.

The brief description of the device buttons is given in the Table 2.

Table 2

Button	Intended use of the buttons in the modes		
	A SCAN	MAP	ADJUSTMENT
	Switching the device on/off. It is necessary to hold the button for more than 0.5 s		
	Activate the ADJUSTMENT mode		Exit the ADJUSTMENT mode
	Activate the operating mode selection window		N/a
 	Cursor movement		Change of the active parameter value
	N/a		Cancel
	Change the developed length	Movement of the vertical cursor	Enter/exit the mode of parameter editing
	Change of amplification value	Movement of the horizontal cursor	Selection of parameters for editing
	Activate the STOP mode		N/a
	N/a	Record the current A-Scan	Activate the parameter adjustment. Activate the memory cleaning procedure when editing the system parameters
	Buttons for selection of icons and control of their functions		

1

1.3.6 Use of icons

The device interface uses an associative menu of icons which are arranged in six rectangular windows in the lower part of the screen. The icons are symbolic images associated with an object or a property they control. Each mode has its own set of icons.

The icons may be in a passive or an active state. In the active state it is possible to change the device properties or parameters corresponding to the active icon.

Note: in the manual the standard numeration is from 1 to 6, from left to right of the icon windows and corresponding functional buttons is used (Figure 6).

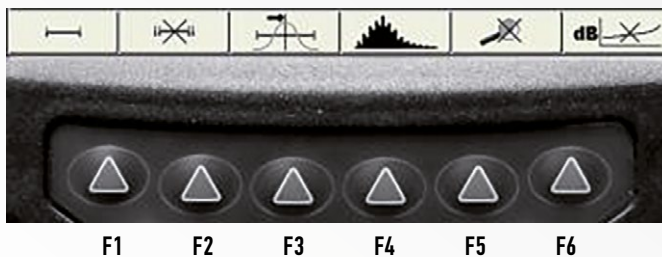

Figure 6

2.1 OPERATING LIMITATIONS

The device is used for operation under the ambient conditions stated in section 1.1.2.

2.2 PREPARING THE DEVICE FOR USE

The protection glass on the screen of the device is covered with a polyethylene film, preventing scratches in the process of production and transportation. Prior to start working it is recommended to remove the protective film to increase the contrast and brightness of the images on the display.

2.2.1 Switching the device on/off

2.2.1.1 Switching on

To switch on the device please press and hold the  button, the LED in the left top corner of the screen lights up green, the splash screen with the corporate logo “ACS”, the device name and the number of firmware download version (Figure 7) appears. After 5 to 10 seconds the window is opened. Always when you switch on the device it returns to the last window active at the moment of the last switching off of the device.

2.2.1.2 Switching off

To switch off the device press the  button.

NOTE: THE DEVICE WILL AUTOMATICALLY SWITCH OFF AFTER THE AUTOMATIC SET PERIOD OF TIME, IF NO BUTTON IS PRESSED AND NO MEASUREMENT IS PERFORMED DURING THE SET PERIOD OF TIME!

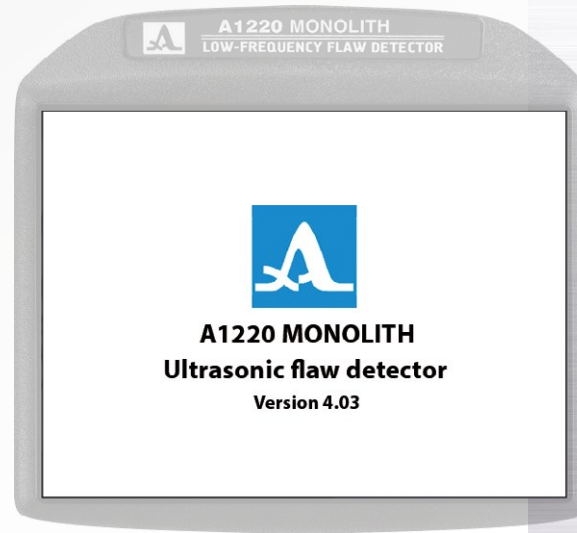

Figure 7

2

INTENDED
USE



2

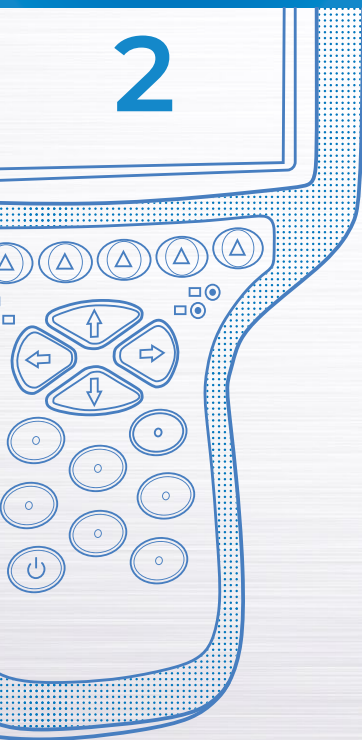

2.2.2 Selection of transducer

The transducers used in the device depend on the task being solved:

- To perform testing using the echo techniques the antenna array is used;
- To perform testing using the shadow techniques the piezoelectric transducer with dry or liquid ultrasonic contact is used.

Detailed recommendations on the use of ultrasonic transducers are given in specialized techniques, documents and other guides on ultrasonic flaw detection of objects, listed in Annex A.







3.1 ADJUSTMENT MODE

The ADJUSTMENT mode is used for adjustment and setting of the device parameters. The first screen in the ADJUSTMENT mode is given on the Figure 8.

There is always an active icon in the icon menu.

The icon functions in the ADJUSTMENT mode are listed in the Table 3.

Table 3

Button	Icon	Function
F1		Adjustment of parameters in the OVERVIEW mode
F2		Adjustment of parameters in the MAP mode
F3		N/A
F4		N/A
F5		Delete a configuration or a map
F6		Select the system settings

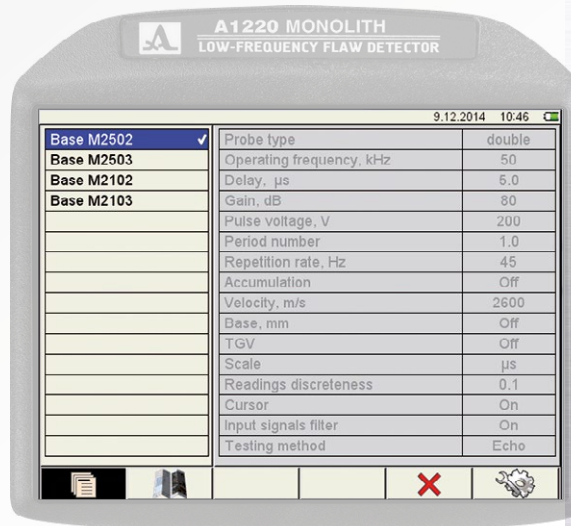

Figure 8

3







OPERATING
MODES OF THE
DEVICE

3



The functions of the buttons activated when editing the parameters are given in the Table 4.

Table 4

Button	Function
	Enter the settings editing
	Move along the lines to select a parameter for editing
	Change the parameter value
	Exit settings editing
	Exit ADJUSTMENT mode
	Switch the parameters on/off. Activate the parameter adjustment

3.1.1 Parameters of A SCAN mode

There is the list of configurations in the left column and parameter names and their values in the right column.

To move to the parameter value editing, press the  button.

The screen of the device when setting the parameters in the A SCAN mode is given on the Figure 8.

The names of the parameters in the A SCAN mode and their permissible values are given in the Table 5.

Table 5

Parameter	Value	Description
Piezoelectric transducer, type	Single crystal / double crystal	Selection of the type of the piezoelectric transducer in use: single crystal; double crystal

Table 4

Parameter	Value	Description
Operating frequency, kHz	From 25 to 250 with pitch 5	Operating ultrasonic frequency during the testing
Delay, mcs	From 0.0 to 100.0 with pitch 0.1	Signal delay time setting
Amplification, dB	From 0 to 100 with pitch 1	Setting of the amplification of the receiving path
Pulse, V	20 / 100 / 200	Selection of monitoring pulse amplitude
Number of periods	From 0.5 to 5.0 with pitch 0.5	Defining of monitoring pulse form
Number of frames, Hz	From 5 to 45 with pitch 5	Selection of the frequency of information displaying
Averaging, number	1 / 2 / 4 / 8 / 16 / 32 / 64 / 128	Setting the number of averages
Ultrasonic speed, m/s	From 500 to 15000	Speed of the operating waves transmission in the testing object
Base, mm	Off / from 10 to 15000	Thickness of the testing object
Time corrected gain	On/off	Switching on the settings Time corrected gain / switching off
Scale	mm / μ s	Selection of horizontal scale units, determining the signal display parameter
Discreteness of values	0.1 / 1	Selection of results display discreteness
Cursor	On / Off	Control of measuring cursor display (vertical line, showing the place where the signal parameters are measured) on the screen
Filter of incoming signals	On / Off	Switching on/off of the filter of incoming signals
Testing method	echo / propagation	Selection of testing method

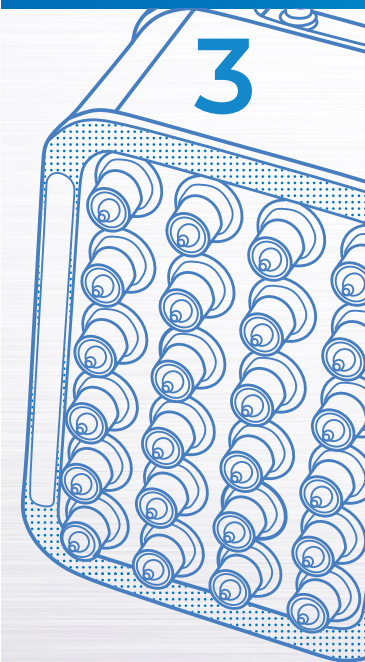



3

3.1.2 View, create and delete a configuration

When entering the ADJUSTMENT mode the line with the current configuration is highlighted, meanwhile all the parameters of the given configuration are displayed on the right in a view mode (Figure 9). The current configuration is marked with the «✓» sign.

3.1.2.1 View the configuration parameters

To view the configuration parameters, please move to the parameter using the   buttons.

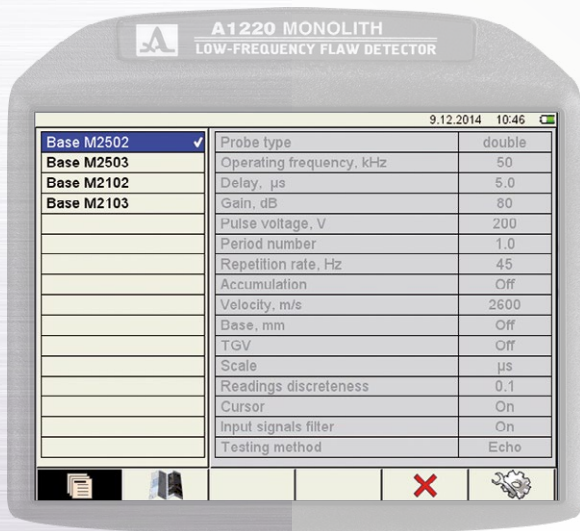

Figure 9

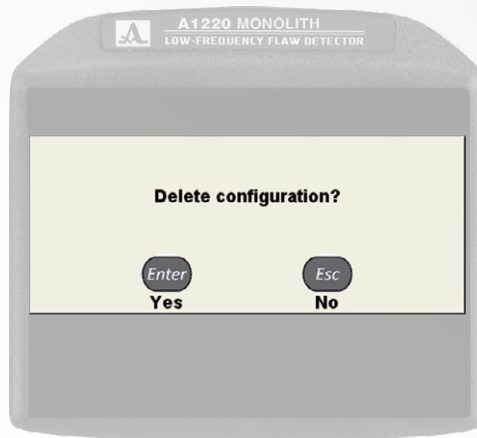







Figure 10

3.1.2.2 Select a configuration

To continue using another configuration from the list, please move to the configuration using the   buttons and press the  button. To return to the measurement mode using the selected configuration, press  .

3.1.2.3 Delete configuration

To delete a saved configuration, please press F5 () button, the deletion confirming window opens (Figure 10).

Note: there are always the following default basic configurations in the list of configurations:

- "Base M2502";
- "Base M2503";
- "Base M2102";
- "Base M2103".

NOTE: IT IS NOT POSSIBLE TO DELETE A BASE CONFIGURATION OR THE CONFIGURATION IN USE (APPLIED CONFIGURATION)!

If you attempt to delete the above mentioned configurations, the corresponding message box opens (Figure 11).

To return to the measurement mode without changing the current configuration, please press the  button.

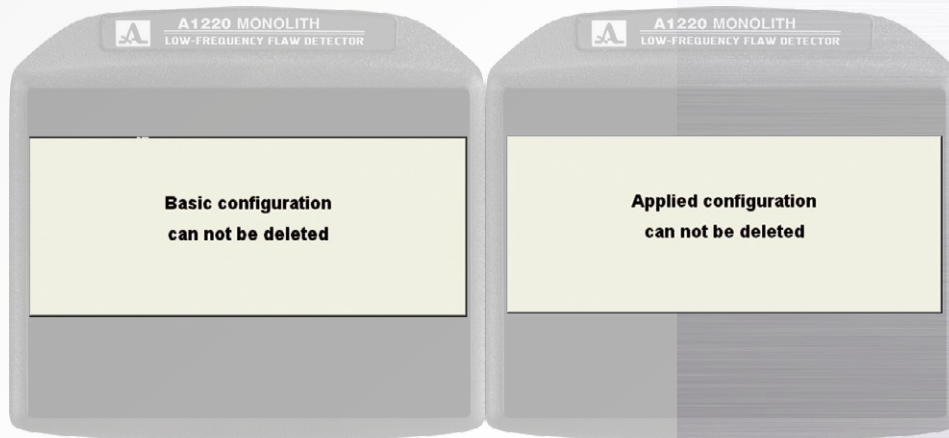





Figure 11

3

3.1.2.4 Create of new configuration

To create a new configuration on the basis of the existing one, please move to the line with configuration, which will serve as a base for editing using the   buttons, for example, "Base M2502" and turn it into the current one by pressing the  button.

To change the values of configuration parameters, please press the  button. The values of the parameters will become editable (Figure 12).

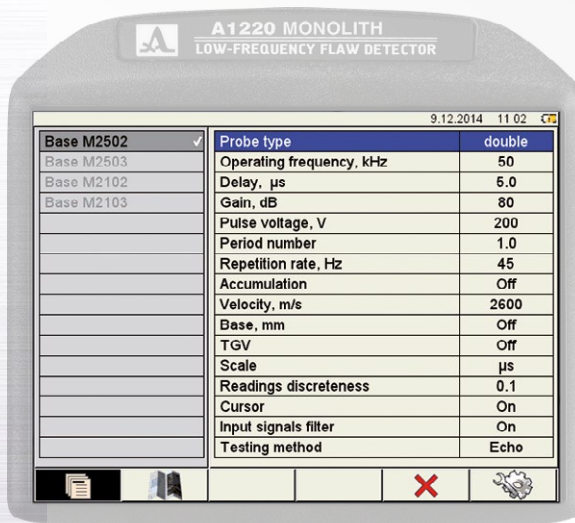

Figure 12

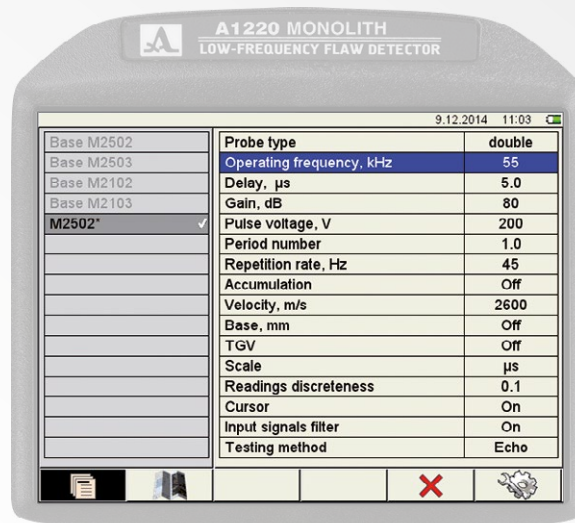

Figure 13

When the value of a configuration parameter is changed, a new line consisting of the name of the configuration being edited with addition of "*" symbol is automatically added in the end of the list of configuration names. The configuration taken as the basis remains unchanged.

Note: when creating a new configuration on the basis of a basic one the word "Base" is not used in the automatic name formation.

The screen when changing the configuration with name "Base M2502" is shown in the Figure 13.

After introducing the necessary changes please exit the parameter editing by pressing the button.

The left column with configuration names becomes active, a temporary name is given automatically, this name of the new configuration is highlighted (Figure 14).

By default, the new configuration becomes current.

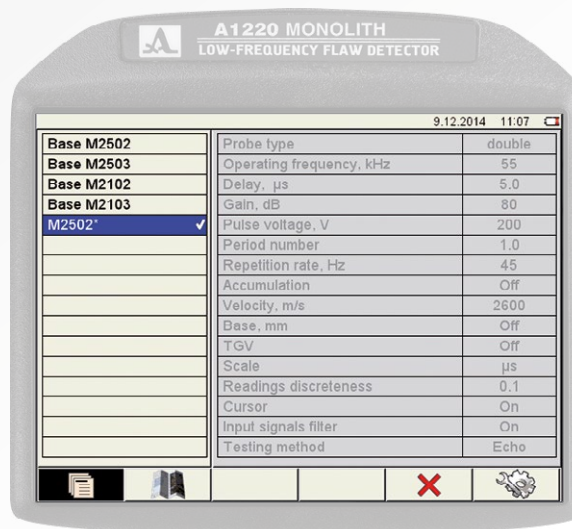
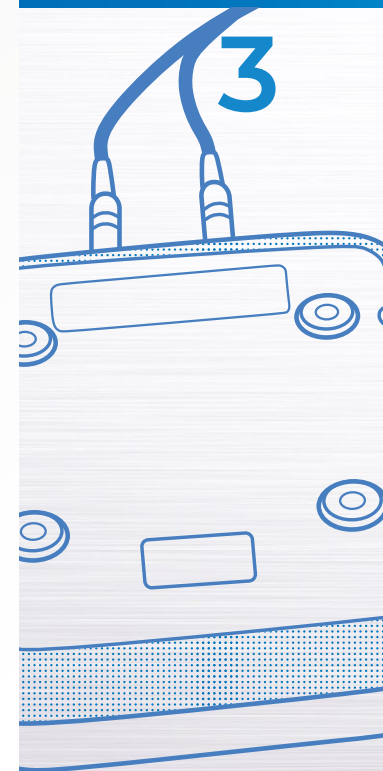

Figure 14





3

To include a configuration in the list of saved configurations, please assign a name to this configuration and press the **Enter** button. The window of the name editing opens (Figure 15).

If the name of a configuration taken as the basis ends with any sign or number without a hyphen in front, a hyphen and a sequence number are added to the name by default.

If the name of a configuration taken as the basis ends with a hyphen and a number, by default its value is increased by one. Any name may be assigned to the configuration (Figure 16).



Figure 15









Figure 16

To save a new name, press the F1 () button.

The configuration with a new name appears in the list and is set as the current one (Figure 17).

The functions of the icons during the name editing are given in the Table 6.

Table 6

Button	Icon	Function
F1		Save the new created name
F2		Move the cursor in the name field to the left
F3		Move the cursor in the name field to the right
F4		Type with capital letters
F5		Delete a symbol located to the left from the cursor
F6		Switch the screen-on keyboard layout (only when using Russian language of the interface)

3

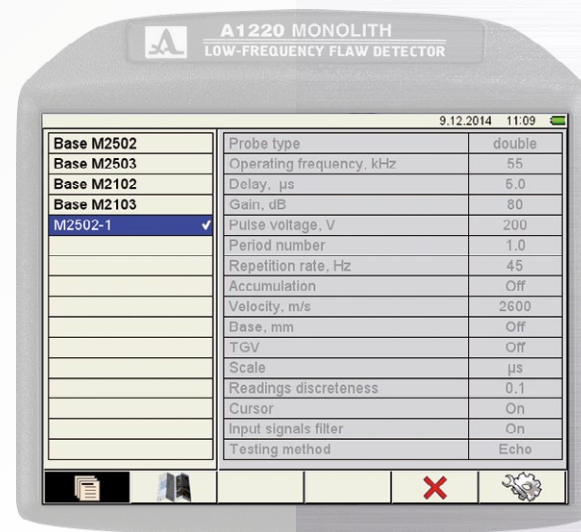
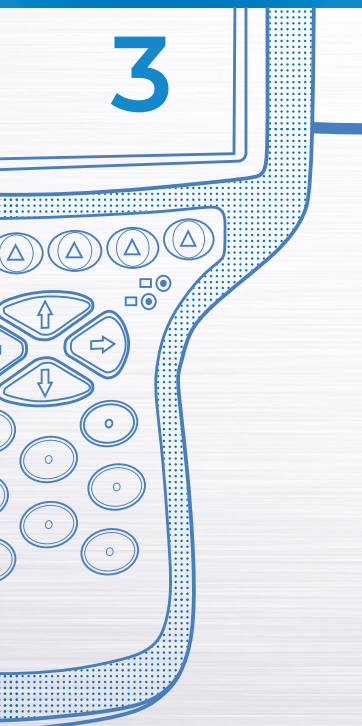





Figure 17

3



Functions of the buttons used for name editing are given in the Table 7.

Table 7

Button	Function
	Move around the keyboard field located at the device screen
	Move the cursor in the name field to the left / to the right
	Enter a symbol in the name field / perform an action highlighted on the keyboard field of the screen
	Exit the name editing in the window of the ADJUSTMENT mode without saving of the name



3.1.3 Parameters of the MAP mode

There is the list of saved maps and a line allowing to create a new map in the left column, and parameter names and their values in the right column.

The screen when setting the parameters in the MAP mode is shown in the Figure 18.

Note: the parameters of the existing maps are available only for viewing.

When a new map is created, the parameters are taken from the current configuration with an option to edit it.

To move to the parameter values editing please move to the line "Create a map..." and press the  button. Then please make all necessary changes in the parameter values and press the  button.

To create a map with the pre-set parameters please press the  button in the line "Create a map...", a window opens, where you create a new map name (Figure 19).

By default, the name MAPX is assigned to a map, where X is an automatically created next number on the basis of previously saved maps. Any name may be assigned to the map. The frame name editing mode is similar to the configuration name editing mode (section 3.1.2).

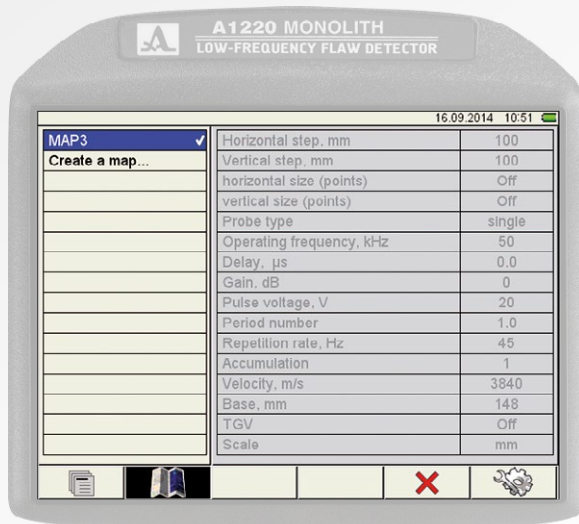
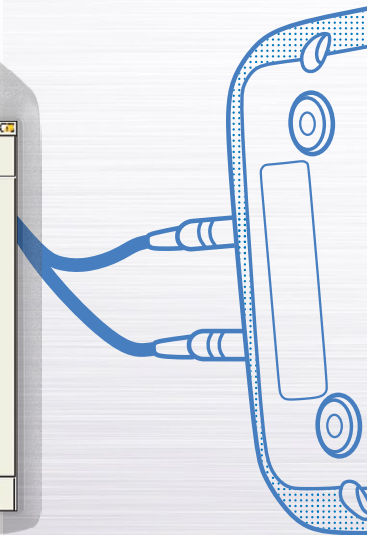

Figure 18



Figure 19



3

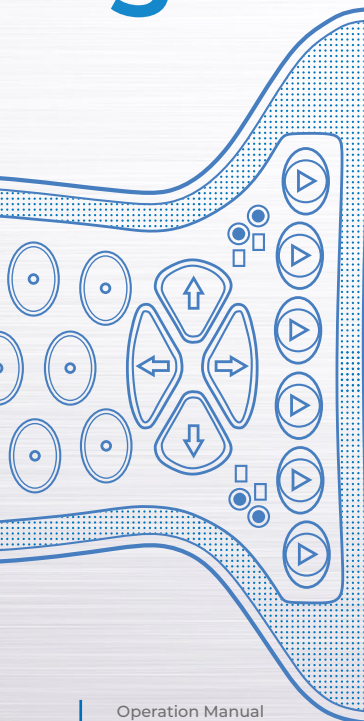

The name of MAP mode parameters and their permissible values are given in the Table 8.

Table 8

Parameter	Value	Description
Pitch horizontally, mm	From 10 to 1000 with pitch 10	Setting the horizontal scanning pitch
Pitch vertically, mm	From 10 to 1000 with pitch 10	Setting the vertical scanning pitch
Size horizontally (points)	Off / from 1 to 100	Setting the size horizontally
Size vertically (points)	Off / from 1 to 100	Setting the size vertically
Piezoelectric transducer, type	single crystal / double crystal	Select the type of piezoelectric transducer in use: single crystal; double crystal
Operating frequency, kHz	From 25 to 250 with pitch 5	Operating ultrasonic frequency during testing
Delay, mcs	From 0.0 to 100.0 with pitch 0.1	Signal delay time setting
Amplification, dB	From 0 to 100 with pitch 1	Setting of the amplification of the receiving path
Pulse, V	20/100/200	Selection of the amplitude of the testing pulse
Number of periods	From 0.5 to 5.0 with pitch 0.5	Defining the form of the testing pulse
Number of frames, Hz	From 5 to 45 with pitch 5	Selection of the frequency of information displaying
Averaging, number	1 / 2 / 4 / 8 / 16 / 32 / 64 / 128	Setting the number of averages
Ultrasonic speed, m/s	From 500 to 15000	Speed of the operating waves transmission in the testing object
Base, mm	Off / from 00 to 15000	Thickness of the testing object
Time corrected gain	On/off	Switching on the settings Time corrected gain / switching off
Scale	mm / mcs	Selection of horizontal scale units, determining the parameter for signal visualisation

3.1.4 Adjustment of time corrected gain

To align the echo-signals amplitudes from the same reflectors located at different depths the time corrected gain function is provided in the device.

To adjust the time corrected gain, it is necessary to have a reference sample of the material, where the size of testing reflectors (near and far) is set.





3.1.4.1 Preparation for adjustment

Before the time corrected gain is adjusted, please do the following in the A SCAN mode:

- Set the sweep in such a way, that signals from all defects in the estimated testing area are displayed;
- Put the strobe at the height of 50-80% of the screen;
- Determine the testing area with the strobe borders;
- Apply an antenna array to the sample and find a maximal signal from a near reflector;
- Set the pulse peak at the level of 50-80% of the screen.

3.1.4.2 Adjustment

To adjust time corrected gain, please do the following:

- Enter the adjustment mode;
- Press the F1 () button;
- Edit the line TCG with the buttons  or  switch on TCG, if it was switched off;
- Press the button  to initiate a setting of TCG;
- Find the signal maximum from a near reflector (Figure 20). Place the measuring cursor on it and create a node point with the  button.

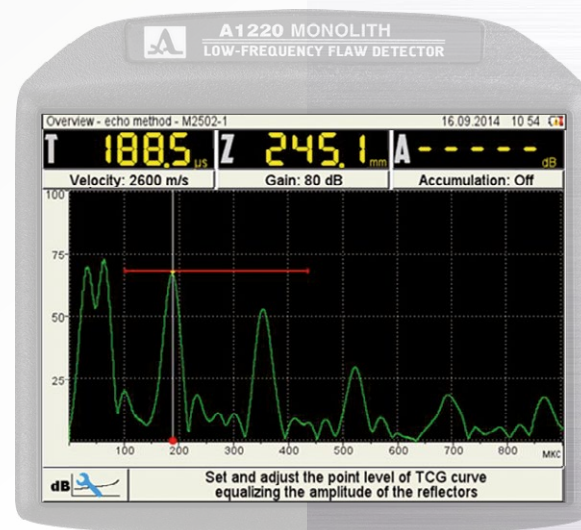
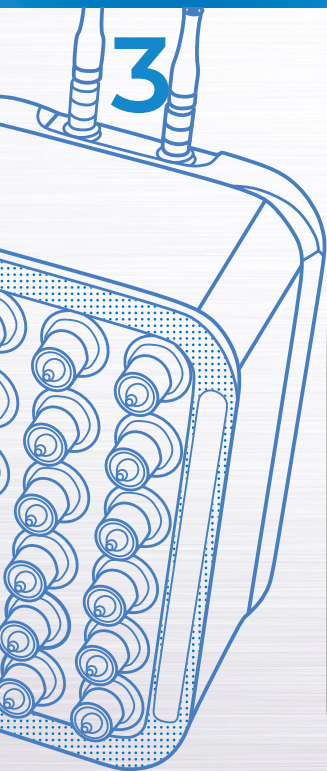



Figure 20



- Repeat the procedure of node point creation for a distant reflector (Figure 21). Correct the vertical position of the point in such a way, that the amplitudes of signals from near and far reflectors are at the level of the strobe.
 - If the sample has more than two testing reflectors, the node points for each of them should be created according to the above given algorithm.
 - Moving the cursor with buttons along the node points, correct the position of the newly created node points in such a way, that amplitudes from near and far reflectors are at the same level.
- To delete a node point, please place the measuring cursor on it and press the  button.

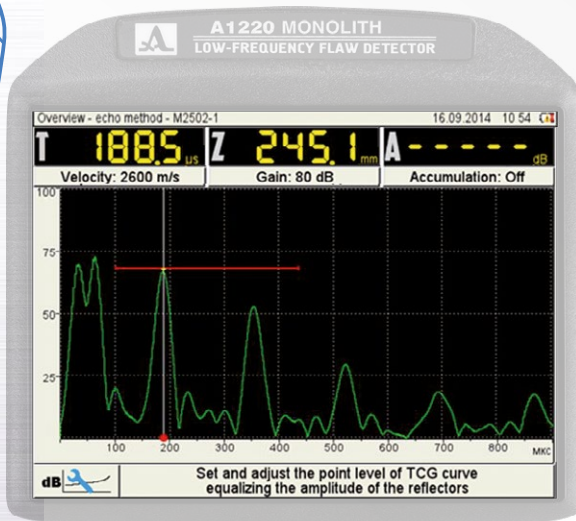

Figure 21

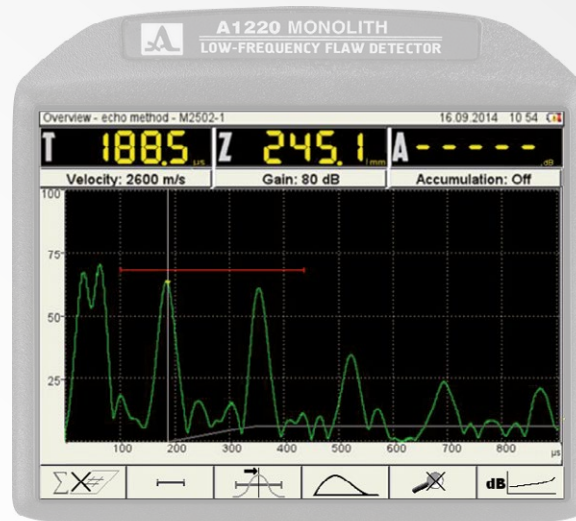









Figure 22

To save the settings and return to the ADJUSTMENT mode, please press the  button.

The screen view after exiting the ADJUSTMENT mode according to the results of the adjustment of time corrected gain is given in the Figure 22.

The functions of the buttons used for the adjustment of the time corrected gain are given in the Table 9.

Table 9

Button	Function
	Change the amplitude of the given point. If there is no point near the cursor, the buttons do not work
	Movement of the cursor
	Movement of the cursor to the nearest point in the corresponding direction
	Exit the mode of the time corrected gain adjustment
	Application of the time corrected gain settings
	Add / delete of a point in the cursor position
	Activate the operating mode selection window



3

3.1.5 System settings of the device

The system settings are common for all operating modes of the device.

The screen when selecting the system settings of the device is given in the Figure 23.

The name of the parameters and their permissible values are given in the Table 10.

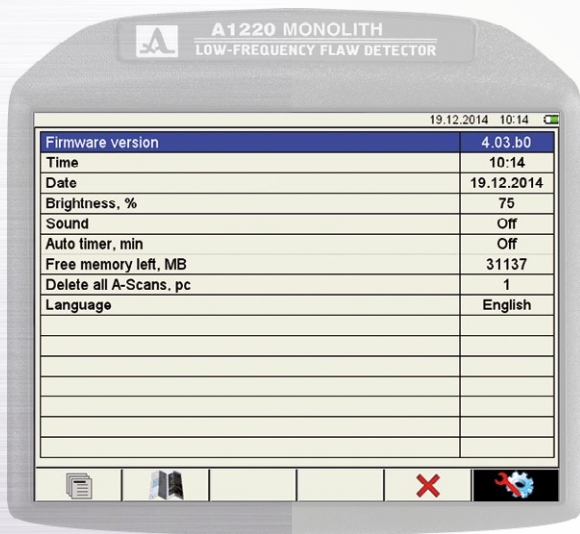

Figure 23

Table 10







Parameter	Value	Description
Firmware version	X.X.X	Current firmware version
Time	HH:MM	Current time in 24-hour format HOURS:MINUTES Enter the editing mode using 
Date	DD.MM.YY	Current date in format DAY.MONTH.YEAR Enter the editing mode using 
Brightness, %	From 5 to 100 with pitch 5	Setting of the screen brightness
Sound	Off / On	Switching on/off of the accompanying sound in case of Automatic Defect Signaling actuation in the device
Timer for the automatic switching off, min.	5 / 10 / 15 / 30 / 60	Select the time after which the device automatically switches off, if no button is pressed and no measurement is performed
Available memory, MB	XXXX	Volume of the available memory of the device

Table 10

Parameter	Value	Description
Delete all A-Scans, pcs.	XXX	Number of saved frames is represented. Start of the device memory cleaning procedure -  WARNING: COMPLETE MEMORY CLEANING, ALL A-SCANS AND MAPS ARE DELETED!
Language	Russian / English	Select the interface language of the device

The functions of the buttons used for system setting editing are given in the Table 11.

Table 11









Button	Function
	Move along the lines to select the parameter for editing
	Change the parameter value
	If "Time" or "Date" parameter is selected, entering the mode for their editing. Start of the memory cleaning procedure
	Exit the ADJUSTMENT mode



3

3.1.5.1 Editing of "Time" and "Date" parameters

To edit "Time" or "Date" parameters, please:

- select the corresponding parameter and press the  button;
- in the opened editing window (Figure 24), select a digit for editing with using the   buttons;
- correct the parameter value with using the   or   buttons;
- to confirm the changes, press the  button, to cancel press the  button.

3.1.5.2 Memory cleaning

After the start of the "Memory cleaning" procedure the warning appears (Figure 25).

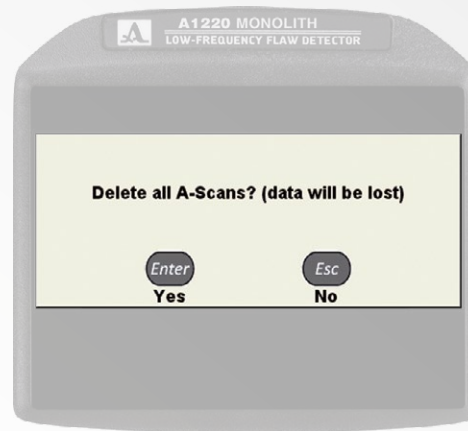
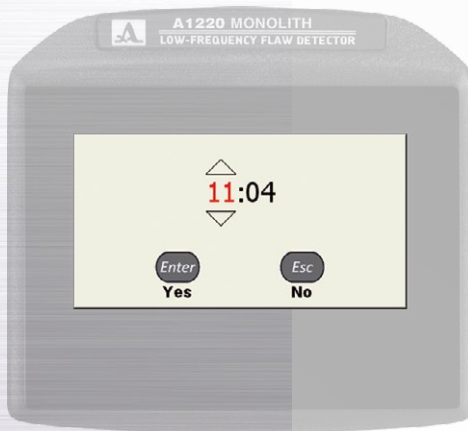

Figure 24

Figure 25



3.2 THE A SCAN MODE (THE ECHO METHOD)

3

The device is equipped with a strobe to set the testing area, susceptibility level, automatic Defect Signaling actuation and the measurement of defect coordinates and signal amplitudes from reflectors in the intervals of interest.

The measurement can be carried out in an automatic as well as manual modes.

In the **Automatic** mode the strobe is on. The value of the point amplitude exceeding the strobe level, depending on the set actuation manner, is measured. If an echo signal gets in a time span of the strobe and the signal amplitude exceeds the strobe level, the cursor is automatically positioned at the place of actuation and indication of the measured parameters. In addition, the fact of exceeding of the strobe level by the signal is accompanied by a sound, the corresponding red LED is switched on on the front panel of the device. If the signal is below the strobe, it is not fixed and measured.

In the **Manual** mode the measurement is performed with the strobe off. The signal is measured by means of the cursor movement using the   buttons.

Besides the cursor, the marker in a form of a colored triangle is displayed on the screen. The marker is always automatically set at the maximum value of the signal amplitude within the strobe.

3.2.1 Screen in the A SCAN mode (the echo method)

The device screen in the A SCAN mode (the echo method) is shown in the Figure 26.

The parameters represented in the blocks Panel of the measurement results and Area of the auxiliary values are changed depending on the operating mode of the device.

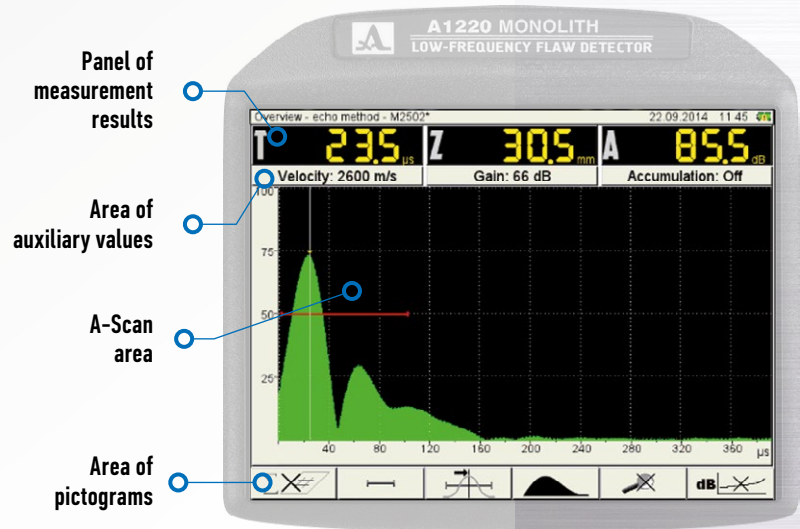
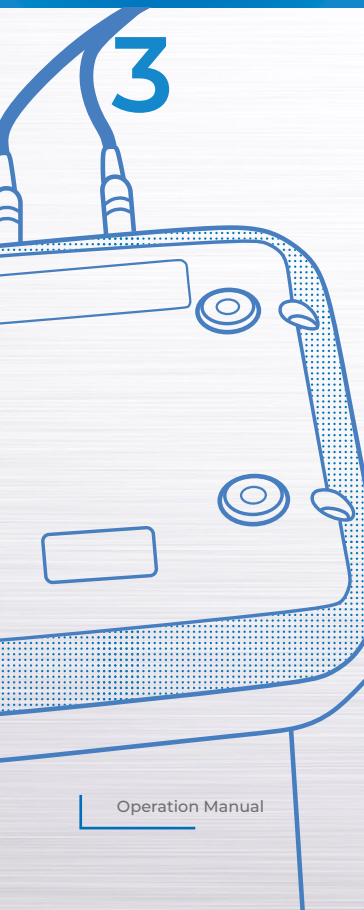

Figure 26



3.2.1.1 With the “BASE - Off” parameter

The following is shown in the Panel of the measurement results (Figure 27):

- In the first block the time, μs ;
- In the second block the depth, mm;
- In the third block the amplitude, dB.

The following is shown in the area of the auxiliary values:

- In the first block the value of ultrasonic speed set in the ADJUSTMENT mode, m/s;
- In the second block the amplification, dB;
- In the third block the value of accumulation set in the ADJUSTMENT mode, or “Off”, if the accumulation is turned off, or the value of the dimensioned accumulation with switched on icon F1 Σ $\#$.



Figure 27

3.2.1.2 If “BASE” parameter is on

The following is shown in the Panel of the measurement results (Figure 28):

- In the first block the speed, m/s;
- In the second block the depth, mm;
- In the third block the amplitude, dB.

The following is shown in the area of the auxiliary values:

- In the first block the value of the base set in the ADJUSTMENT mode, mm;
- In the second block the amplification, dB;
- In the third block the value of the accumulation set in the ADJUSTMENT mode, or “Off”, if the accumulation is turned off.



Figure 28

3.2.1.3 The grid, vertical and horizontal scale, strobe, cursor and marker are shown in the A-Scan area besides the A-Scan. The cursor and marker are automatically redrawn in case of the results update.

The horizontal scale of the device is switched between microseconds and millimeters.







3.2.1.4 The icon area is located below. Each icon is controlled with the corresponding button on the device panel. The main functions of the buttons and the corresponding icons in the A SCAN mode:

- F1 control the dimensioned accumulation;
- F2 control the strobe;
- F3 selection of the Automatic Defect Signaling actuation type;
- F4 selection of the signal reflection type;
- F5 switching on/off of the ZOOM mode;
- F6 switching on/off the TCG.

3.2.2 Functions of the buttons in the A SCAN mode

The functions of the buttons used in the A SCAN mode are given in the Table 12.

Table 12

Button	Function
	Switching the device on/off
	Moving the measurement cursor
	Up/down change of attenuator value To the right/to the left change of the scanning length
	Enter the STOP mode
	F1 – F6 edit the corresponding parameter
	Enter the ADJUSTMENT mode

3

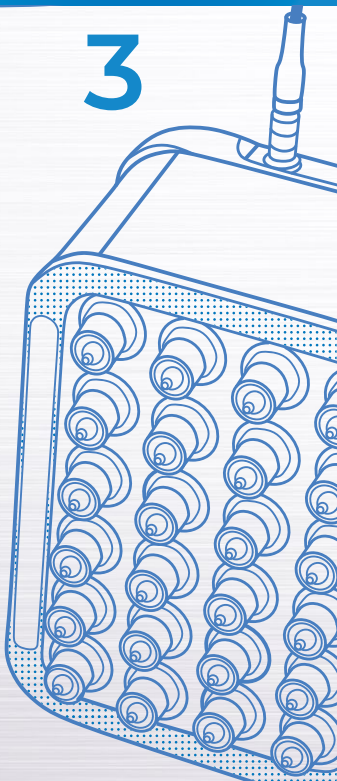

3.2.2 Functions of the controlling icons

F1 (dimensioned accumulation)



the dimensioned accumulation is off;

the dimensioned accumulation is on.

After the dimensioned accumulation is switched on the temporary accumulation set up in dimensioned accumulation, defined in the SETTING mode is automatically switched off, and vice versa when the temporary accumulation in the SETTING mode is switched on, the dimensioned accumulation is automatically switched off.

F2 (strobe)

The strobe is used to set the testing areas, the susceptibility levels and to actuate the Automatic Defect Signaling, the measurement of defect coordinates and signal amplitudes from reflectors in the interval needed.

If the signal exceeds the strobe level, the cursor is automatically set at the point where the exceeding has occurred (or at the maximum), the corresponding parameters of the cursor in this point are displayed, and sound and light indication occurs (Automatic Defect Signaling actuation).

If the strobe is located outside of the displayed area, a pointer appears near the right border of the area allowing the determination of the strobe threshold level (a single red arrow).

ATTENTION: IF THE SIGNAL AMPLITUDE EXCEEDS THE LEVEL OF THE STROBE WHICH IS OUTSIDE OF THE DISPLAYED AREA, THE AUTOMATIC DEFECT SIGNALING ACTUATION OCCURS, BUT THE CURSOR AND MARKER ARE NOT DISPLAYED!





The functions of the buttons used in case of an active icon  are given in the Table 13.

On the panel with the measurement results there is the beginning of the strobe (X1) in the first block, the end of the strobe (X2) in the second block, the level of the strobe (A) in the third block (Figure 29).



Figure 29

Table 13

Button	Function
	Move the strobe in the corresponding direction
	Change the strobe length relatively to its left border
	Switch the strobe off and exit the settings. The strobe switches on when you enter the strobe settings using the F2 button
	F2 exit the editing mode F1, F2 – F5 exit the editing mode and fulfill the function of a pressed button
	Enter the ADJUSTMENT mode

F3 (actuation type)

Selection the actuation type of the Automatic Defect Signaling



- at the signal maximum in the strobe;



- at the first exceeding signal of the strobe level.

In the measurement mode the maximum positions of the cursor and marker are the same.

F4 (signal type)

Switching of the signal type in the A-Scan area:



detected contour;



detected, filled;



radio signal.

F5 (zoom)

the ZOOM mode is off;



the ZOOM mode is on.



3

3

If the ZOOM mode is on, the signal is displayed within the time span, corresponding to the strobe, which allows the detailed assessment of the form of a temporary signal realization within the strobe.

The screen in the ZOOM mode is shown in the Figure 30.

F6 (time corrected gain)

-  the time corrected gain curve is on;
-  the time corrected gain curve is off.

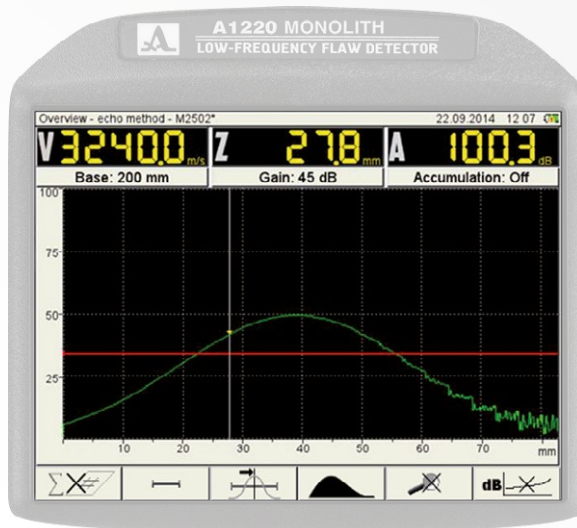

Figure 30

3.3 A SCAN MODE (PROPAGATION METHOD)

The interface of the A SCAN mode (in the propagation method) completely coincides with the interface of the A SCAN mode (in the echo method), only the A-Scan line is colored with the yellow color.

3.3.1 The screen in the A SCAN mode (propagation method)

The screen of the device in the A SCAN mode (propagation method) is shown on the Figure 31.

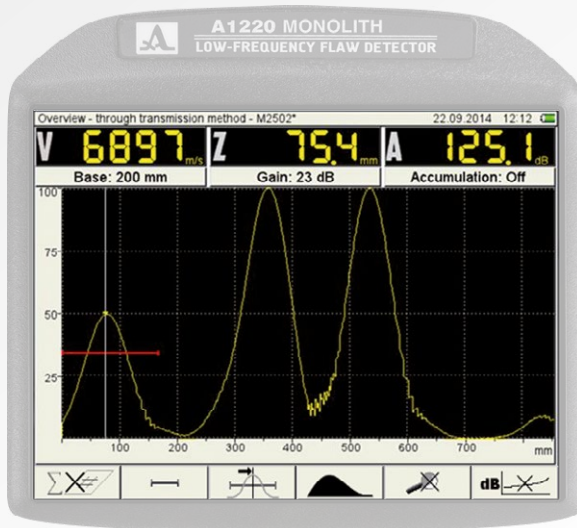
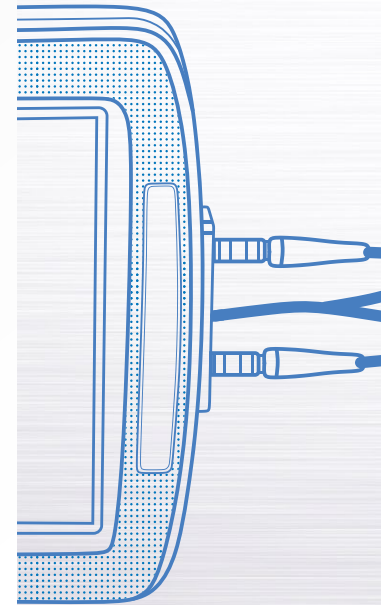

Figure 31

3



3

3.4 MAP MODE

The MAP mode is used to form a set of images of the tested object sections perpendicular to its surface when scanning of the antenna array along the previously marked lines (rows) with a constant pitch.

3.4.1 The screen in the MAP mode

The view of the device in the MAP mode is shown on the Figure 32.

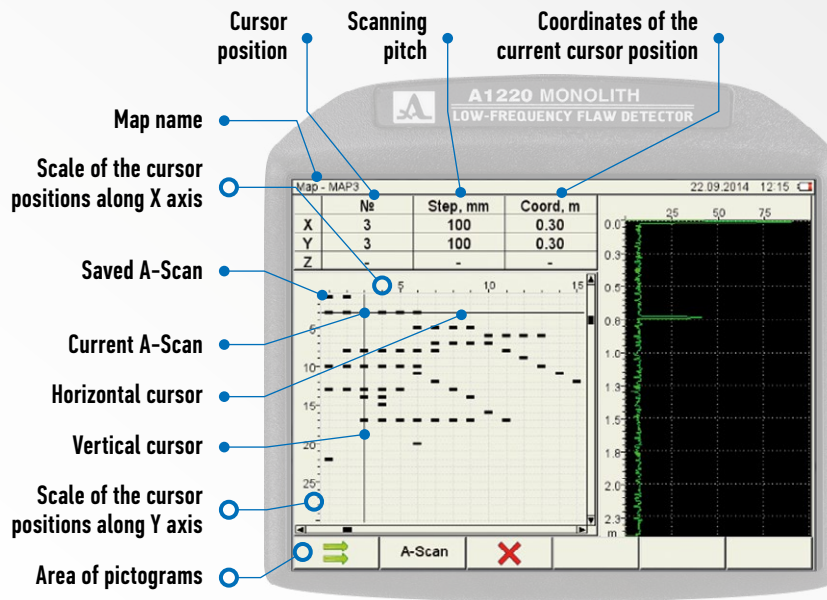
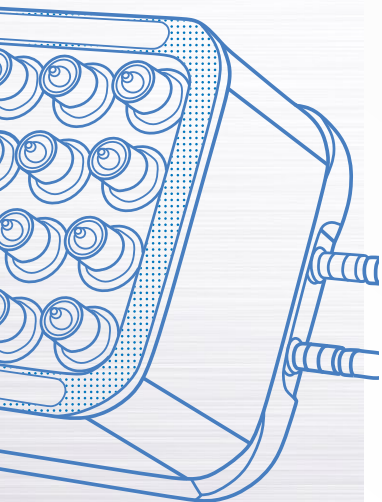







Figure 32

3.4.2 Functions of the buttons in the MAP mode





The functions of the buttons used in the MAP mode are given in the Table 14.

Table 14

Button	Function
	Switch the device on/off of
	Move of the horizontal and vertical cursor in the field of maps
	Save the current A-Scan
	F1, F2, F3 control the corresponding parameter
	Enter the ADJUSTMENT mode

3.4.3 Functions of the controlling icons

F1 (scanning direction)

		horizontal scanning;
		vertical scanning.

F2 (view of a reflected signal)

A-Scan	signal reflected in the A-scan mode;
B-Scan	signal irectified in the B-scan mode;
D-Scan	signal is reflected in the D Scan mode.

F3 (deletion of saved signals)

	deletion of the selected saved signal on the map.
--	---

3

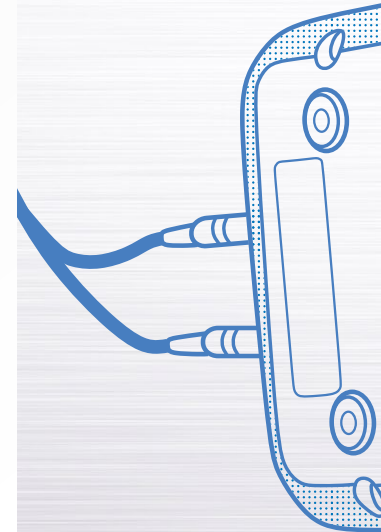



3

3.5 STOP MODE

If the  button is pressed in the A SCAN mode, the mode of saving and viewing of the previously saved A-Scans (frames) starts (Figure 33).

The icon functions when entering the STOP mode are given in the Table 15.

Table 15

Button	Icon	Function
F1		Frame saving in the STOP mode
F2		Start viewing the saved frames

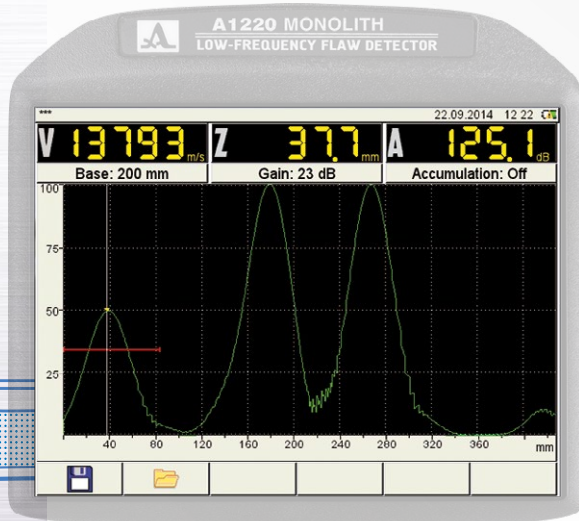

Figure 33



Figure 34

3.5.1 Saving the current frame

If the F1 button is pressed, the device starts the editing the name of a new frame (Figure 34).

By default, the name of a frame is formed using the word "Frame", a hyphen and then a serial number of the frame.



Any name may be assigned to a frame. Editing of the frame name is similar to the editing of the configuration name (paragraph 3.1.2).

3.6 WORK WITH PREVIOUSLY SAVED FRAMES

If F2 button is pressed, the device starts the mode of viewing and deletion of saved frames (Figure 35).

The functions of the icons in the STOP mode are given in the Table 16.

Table 15

Button	Icon	Function
F2		Move to the previously saved frame
F1		Move to the next saved frame
F3		Delete the current saved frame

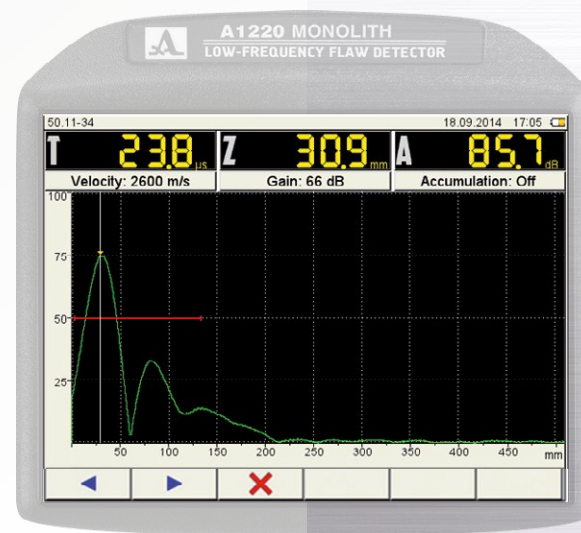

Figure 35

If the F3 button is pressed, the window with the name of the frame being deleted opens (Figure 36). The functions of the buttons used in the STOP mode are given in the Table 17.

Table 17



Button	Function
	Movement of the measurement cursor before saving of the frame
	Exit the STOP mode



Figure 25

4.1 POWER SUPPLY AND POWER CONSUMPTION

4.1.1 Checking the state of the power source

While the device is in operation, a built-in charge controller monitors the discharge degree of the power source. Its embedded discharge controller monitors the state of charge of the power source. This state is displayed as a battery icon in the upper right corner of the display. The battery icon will be filled according to the degree of charge. Completely filled green battery icon means that the accumulator battery is charged completely. As far as the battery discharges the filling degree decreases and the icon changes its color from orange to red. The device will be automatically switched off when the battery is critically discharged. All the settings and recorded information will be saved.

4.2 MAINTENANCE FREQUENCY

During the operation it is recommended to clean the device body from dirt and dust regularly using a cleaning agent for plastic items. If the protective glass of the screen is dirty, please wipe it with a soft cloth moistened in a household cleaning agent for plastic glasses.

The dirty keyboard can be cleaned with alcohol.

If dirt or foreign matter get in the arming connectors, they should be cleaned with a soft brush.

4.3 POTENTIAL PROBLEMS

In case of any problems or questions concerning the use of the device, please, contact the company representative by phone. The numbers are indicated in the data sheet of the device.

4.4 STORAGE

The device should be stored in a transport suitcase included in the scope of delivery of the device. The devices should be stored in racks.

The arrangement of the devices in warehouses shall enable their free movement and unrestricted access to them.

The distance between the devices and the walls, floor of the warehouse and other warehoused instruments shall be at least 100 mm. The distance between heating units of the storage room and the devices should be min. 0.5 m.

The storage room shall be free from the current-conducting dust, admixtures of aggressive gases and corrosive vapors able to attack the instruments.



5

TRANSPOR- TATION

The device should be transported in a transportation suitcase included in the scope of delivery of the device. The packaged devices can be transported in any vehicles at any distances without speed limits. Packaged devices should be properly and steadily fixed to prevent their hitting against one another and against vehicle walls during transportation. When transported in open vehicles the instruments shall be protected from rain and water splashes. The arrangement and fixation of the packed devices in transport facilities should provide their stable position and exclude strokes against each other as well as against the walls of the transportation facilities. The conditions for device transportation should meet the requirements of the valid specifications, rules and norms for each type of transport. If shipped by air, properly packed devices should be placed in hermetically sealed heated compartments. If transportation conditions differ from the operation conditions, the device shall be kept under normal weather conditions for at least 2 hours prior to operation.

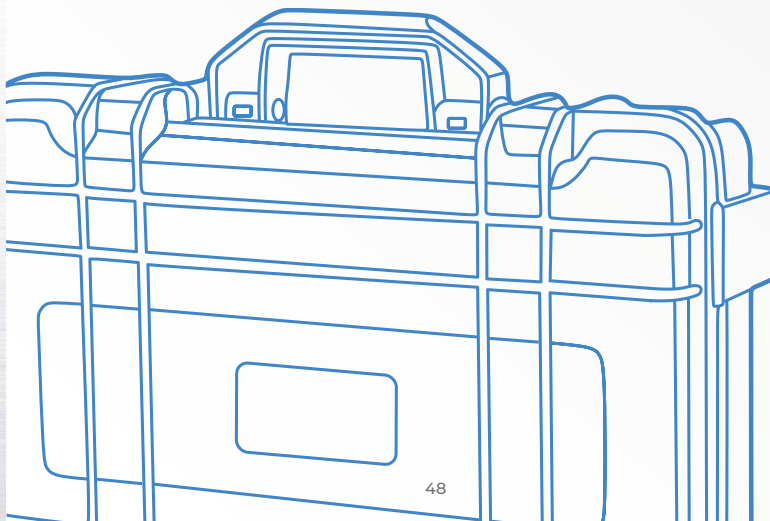

RECOMMENDED LITERATURE ON ULTRASONIC TESTING

1. Nondestructive testing and diagnostics: handbook / edited by V.V. Klyuev et al. – 3rd edition, revised and edited. – M.: Mashinostroenie, 2005. – 656 p.
2. Nondestructive testing: handbook: in 8 volumes / under general editorship of V.V. Klyuev. Volume 3: I.N. Ermolov, Y.V. Lange. Ultrasonic testing. – 2nd edition, revised. – M.: Mashinostroenie, 2006. – 864 p.: pic.
3. Ermolov I.N., Ermolov M.I. Ultrasonic testing. Textbook for specialists of the first and the second qualification levels. – 5th edition stereotyp. – M.: Azimut, 2006. – 208 p.: 77 pic.
4. Scherbinskij V.G. Technology of ultrasonic testing of welded joints. – 2nd edition, revised. – M.: Tisso, 2005. – 326 p.
5. Kretoy E.F. Ultrasonic flaw detection in power-plant engineering. Tutorial / 3rd edition, revised and edited. – SPb: Sven, 2011. – 305 p.

APPENDIX A (references)



NOTES



ULTRASONIC FLAW DETECTOR

A1220 **MONOLITH**



OPERATION MANUAL

Revision: February 2018