

# OPERATION MANUAL

DAKOTA ULTRASONICS

## HPX<sup>DL+</sup>

High Penetration A/B Scan Thickness Gauge

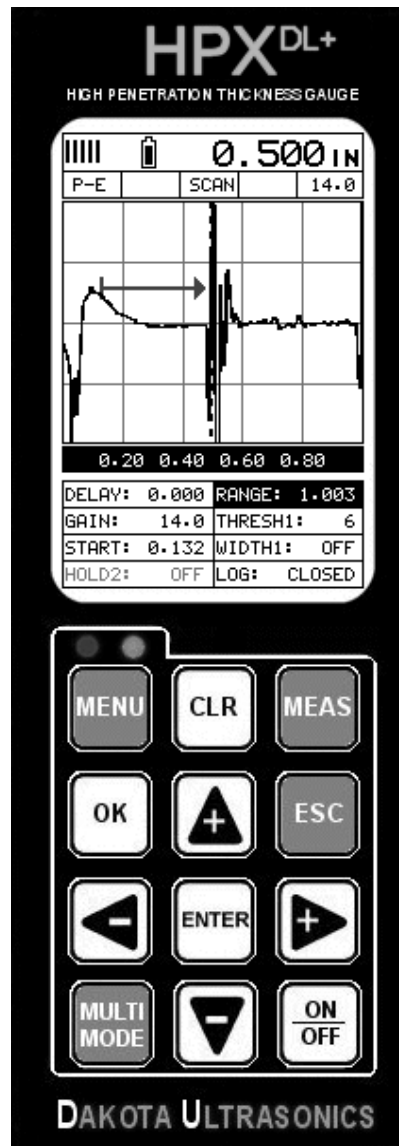



# CONTENTS

|   |           |
|---|-----------|
| <b>CHAPTER ONE INTRODUCTION.....</b>                                | <b>1</b>  |
| 1.1 DISCLAIMER.....   | 1         |
| <b>CHAPTER TWO QUICK STARTUP GUIDE.....</b>                         | <b>2</b>  |
| 2.1 HPX OVERVIEW.....   | 2         |
| 2.2 TABBED & HOT MENU REFERENCE.....                                | 5         |
| 2.3 SELECTING THE TRANSDUCER TYPE.....                              | 7         |
| 2.4 PROBE ZERO & CALIBRATION.....                                   | 8         |
| ONE POINT MATERIAL CALIBRATION.....                                 | 9         |
| 2.5 MEASURE.....  | 11        |
| <b>CHAPTER THREE KEYBOARD, MENU, &amp; CONNECTOR REFERENCE.....</b> | <b>15</b> |
| 3.1 MENU KEY (OPERATION & SUB MENUS).....                           | 15        |
| 3.2 PROBE – MENU.....   | 16        |
| 3.3 CAL – MENU.....   | 17        |
| 3.4 DISP (DISPLAY) – MENU.....                                      | 17        |
| 3.5 TUNE – MENU.....  | 18        |
| 3.6 GT1 – MENU.....   | 19        |
| 3.7 GT2 – MENU.....   | 20        |
| 3.8 GT3 – MENU.....   | 20        |
| 3.9 SETUP – MENU.....   | 20        |
| 3.10 DATA – MENU.....   | 21        |
| 3.11 UTIL (UTILITIES) – MENU.....                                   | 22        |
| 3.12 XFER (TRANSFER) – MENU.....                                    | 22        |
| 3.13 CLR (CLEAR) KEY.....   | 23        |
| 3.14 MEAS (MEASUREMENT MODE) KEY.....                               | 23        |
| 3.15 OK KEY.....  | 23        |
| 3.16 ESC KEY.....   | 23        |
| 3.17 ARROW KEYS.....  | 23        |
| 3.18 ENTER KEY.....   | 24        |
| 3.19 MULTI MODE KEY.....  | 24        |
| 3.20 ON/OFF KEY.....  | 24        |
| 3.21 TOP & BOTTOM END CAPS.....                                     | 25        |
| <b>CHAPTER FOUR PRINCIPALS OF ULTRASONIC MEASUREMENT .....</b>      | <b>26</b> |
| 4.1 TIME VERSUS THICKNESS RELATIONSHIP.....                         | 26        |
| 4.2 SUITABILITY OF MATERIALS.....                                   | 26        |

|  |           |
|--|-----------|
| 4.3 RANGE OF MEASUREMENT AND ACCURACY .....                | 26        |
| 4.4 COUPLANT .....   | 26        |
| 4.5 TEMPERATURE.....                                       | 26        |
| 4.6 MEASUREMENT MODES.....                                 | 27        |
| <b>CHAPTER FIVE MAKING MEASUREMENTS .....</b>              | <b>30</b> |
| 5.1 SELECTING TRANSDUCER TYPE.....                         | 30        |
| 5.2 PROBE ZERO .....                                       | 32        |
| 5.3 MATERIAL CALIBRATION .....                             | 35        |
| <b>CHAPTER SIX DISPLAY VIEW OPTIONS.....</b>               | <b>43</b> |
| 6.1 DISPLAY VIEWS.....                                     | 43        |
| 6.2 CHANGING DISPLAY OPTIONS.....                          | 51        |
| <b>CHAPTER SEVEN ADJUSTING THE SCOPE.....</b>              | <b>52</b> |
| 7.1 DELAY & RANGE (B-START/B-DEPTH) .....                  | 52        |
| 7.2 GAIN – MANUAL & AUTO (AGC) .....                       | 56        |
| 7.3 THRESHOLD.....   | 59        |
| 7.4 UNDERSTANDING THE FEATURES OF THE GATE .....           | 62        |
| 7.5 GATES.....   | 64        |
| <b>CHAPTER EIGHT THRU PAINT MEASUREMENT TECHNIQUE.....</b> | <b>69</b> |
| 8.1 INTRODUCTION TO THRU PAINT MEASUREMENT .....           | 69        |
| 8.2 USING THRU PAINT MODE .....                            | 69        |
| <b>CHAPTER NINE ADDITIONAL FEATURES OF THE HPX.....</b>    | <b>72</b> |
| 9.1 UNITS.....   | 72        |
| 9.2 BACKLIGHT .....  | 73        |
| 9.3 CONTRAST.....  | 73        |
| 9.4 RECTIFIED WAVE OPTIONS.....                            | 74        |
| 9.5 DETECT MARK .....                                      | 75        |
| 9.6 POLARITY .....   | 76        |
| 9.7 PULSE WIDTH.....                                       | 78        |
| 9.8 PULSER VOLTAGE.....                                    | 79        |
| 9.9 DAMPING .....  | 80        |
| 9.10 AGC MAX.....  | 81        |
| 9.11 GAIN SLOPE (TDG).....                                 | 82        |
| 9.12 TDG START .....                                       | 83        |
| 9.13 AUTO FIND .....                                       | 84        |
| 9.14 HIGH SPEED SCAN.....                                  | 85        |
| 9.15 ALARM MODE .....                                      | 86        |

|   |            |
|---|------------|
| 9.16 DIFFERENTIAL MODE .....  | 88         |
| 9.17 KEY CLICK .....  | 90         |
| 9.18 SET DATE & TIME.....   | 91         |
| 9.19 SHOW DATE & TIME .....   | 92         |
| 9.20 CAPTURE TO FILE.....   | 93         |
| 9.21 CAPTURE VIEWER .....   | 94         |
| <b>CHAPTER TEN DATA STORAGE – SETUP, EDIT, &amp; VIEW FILES .....</b> | <b>96</b>  |
| 10.1 INTRODUCTION TO GRID AND SEQUENTIAL FILE FORMATS .....           | 96         |
| 10.2 CREATING A NEW GRID OR SEQUENTIAL LOG (FILE) .....               | 97         |
| 10.3 STORING A READING.....   | 106        |
| 10.4 VIEWING STORED READINGS .....                                    | 108        |
| 10.5 DELETING GRIDS (FILES).....                                      | 109        |
| 10.6 EDITING A GRID (FILE).....                                       | 112        |
| 10.7 CHANGING THE ACTIVE FILE - OPEN .....                            | 114        |
| 10.8 CLOSING AN ACTIVE FILE - CLOSE.....                              | 116        |
| <b>CHAPTER ELEVEN SETUPS – CREATE, STORE, EDIT, &amp; RECALL.....</b> | <b>118</b> |
| 11.1 INTRODUCTION TO SETUPS.....                                      | 118        |
| 11.2 OPENING A SETUP.....   | 118        |
| 11.3 SAVING & EDITING A SETUP.....                                    | 119        |
| 11.4 DELETING A SAVED SETUP .....                                     | 122        |
| 11.5 USING THE DEFAULT SETUP .....                                    | 124        |
| 11.6 SELECTING A LANGUAGE .....                                       | 125        |
| <b>CHAPTER TWELVE USING THE UTILITY SOFTWARE .....</b>                | <b>127</b> |
| 12.1 COMPUTER SYSTEM REQUIREMENTS .....                               | 127        |
| 12.2 INSTALLING DAKVIEW .....   | 127        |
| 12.3 COMMUNICATING WITH THE <i>HPX</i> .....                          | 127        |
| 12.4 LINE POWER .....   | 127        |
| 12.5 UPGRADING THE <i>HPX</i> .....                                   | 127        |
| <b>APPENDIX A - VELOCITY TABLE .....</b>                              | <b>129</b> |
| <b>APPENDIX B - SETUP LIBRARY .....</b>                               | <b>131</b> |



## CHAPTER ONE INTRODUCTION

The Dakota Ultrasonics model **HPX** is a high penetration A / B scan ultrasonic thickness gauge. Based on the same operating principles as SONAR, the **HPX** is capable of measuring the thickness of various materials with accuracy as high as  $\pm 0.001$  inches, or  $\pm 0.01$  millimeters. The principle advantage of ultrasonic measurement over traditional methods is that ultrasonic measurements can be performed with access to only one side of the material being measured.

Dakota Ultrasonics maintains a customer support resource in order to assist users with questions or difficulties not covered in this manual. Customer support may be reached at any of the following:

|  |
|--|
| Dakota Ultrasonics Corporation   |
| 1500 Green Hills Road, #107  |
| Scotts Valley, CA 95066 USA  |
| Telephone: (831) 431-9722  |
| Facsimile: (831) 431-9723  |
| <a href="http://www.dakotaultrasonics.com">www.dakotaultrasonics.com</a> |

### 1.1 Disclaimer

The **HPX** is a full-featured scope that allows a great deal of control over the functionality and electronic performance of the instrument. However, as this provides the user greater control and versatility for a variety of applications, it also requires that the user be comfortable with operation and waveform interpretation of the instrument. It is strongly recommended that the contents of this manual be read in its entirety. It is also recommended that a sufficient amount of time be allocated to working with the instrument in a test environment prior to use in the field. Responsibility for proper use of the instrument rest solely with the user of the instrument.

## CHAPTER TWO QUICK STARTUP GUIDE

Turn the **HPX** on and off using the switch located on the bottom right corner of the keypad. When **HPX** is initially turned on, a flash logo and blinking lights will be displayed prior to entering into the main measurement screen. **Note:** *This section is primarily written as a basic startup guide only.*

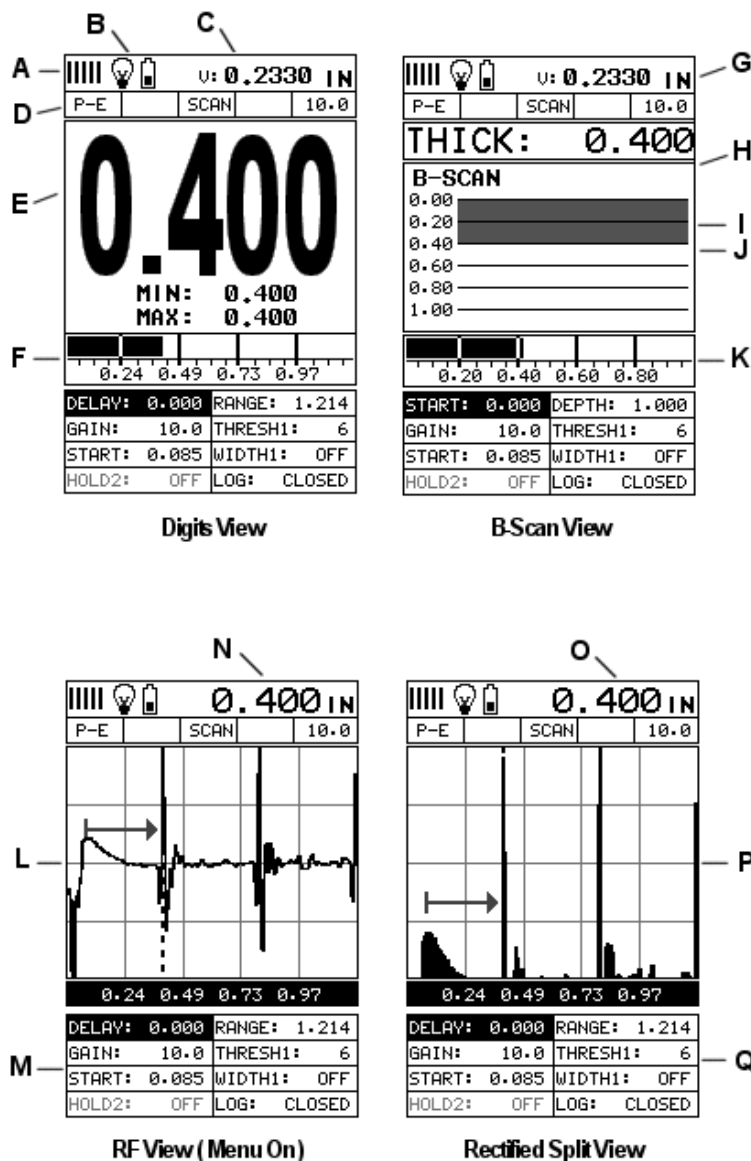

### 2.1 HPX Overview





In order to understand how to operate the **HPX**, it's best to start off with an understanding of what it is we're looking at. The **HPX** has a lot of great features and tools that will prove to be a huge benefit for the variety of applications you're constantly facing on a continual basis. Let's have a brief look at the screens you'll see most often:

- A. **Repeatability/Stability Indicator** – This indicator should be commonly used in conjunction with the digital thickness values displayed. When all the vertical bars are fully illuminated and the last digit on the digital thickness value is stable, the **HPX** is reliably measuring the same value approximately 250 times per second (250 Hz), depending on which measurement mode and features are enabled.
- B. **Battery Icon** – Indicates the amount of battery life the **HPX** has remaining.
- C. **Velocity** – The material velocity value the **HPX** is currently using or calibrated for. Displayed in both English or Metric units, depending on what units the gauge is set for.
- D. **Feature Status Bar** – Indicates the features currently enabled and in use in the following order:
  - Measurement Mode
  - Differential Mode
  - High Speed Scan Mode
  - Alarm Mode
  - Gain Setting
- E. **Digital Material Thickness Value** – Extra large font size for viewing ease.
- F. **Scan Bar** – Another view of material thickness in a deflection style horizontal bar. This is a visual tool that would enable the user the ability to see thickness changes in both standard and scan modes.
- G. **Units** – The current measurement units being used (English, Metric).
- H. **Digital Material Thickness Value** – Smaller font size when the B-Scan display view is enabled.
- I. **Minimum Material Thickness** – Part of the scan feature. Displays the minimum thickness value found during a scan.
- J. **Maximum Material Thickness** – Part of the scan feature. Displays the maximum thickness value found during a scan.
- K. **B-Scan Display** – Cross section view of the material. Provides the user with graphical view of the opposite/blind surface.
- L. **RF A-Scan Display** – The actual sound wave reflection that is returned from the detection of the opposite surface of the material being measured. In this view, the entire sine wave is displayed, showing both the positive and negative half cycles from the detection/reflection. This view is commonly used to initially “see the big picture” and make fine adjustments to the scope settings, prior to selecting another view option.

- M. **Hot Menu items** – We call this menu section our “hot menu”, as these items are the most commonly adjusted features, requiring quick access from the user. They can be displayed and scrolled by pressing the  key at anytime. The  key is used in conjunction with  key to reverse the direction scrolled.
- N. **Reference Note** – When the “hot menu” items are displayed/activated, the base material thickness value shown at reference point “N”. However, when the “hot menu” items have been deactivated, the current base material velocity value is displayed, as shown in reference point “O”. When the “hot menus” are deactivated, the entire “hot menu” section becomes a multiple measurement display area, allowing the user to simultaneously view: base material, coating, and base material minimum/maximum thickness values dynamically, as shown in reference point “R”.
- O. **Reference Note** – Please refer to “N”, for a detailed explanation.
- P. **RECT A-Scan Display** – The actual sound wave reflection that is returned from the detection of the opposite surface of the material being measured. In this view, only half of the sine wave is being displayed (positive or negative).
- Q. **Reference Note** – Please refer to “N”, for a detailed explanation.

## 2.2 Tabbed & Hot Menu Reference

The following table is a quick menu reference guide of the tabbed menu items, which can be accessed by pressing the **MENU** key multiple times to tab right, or the **ESC** key multiple times to tab left through the tabbed menus. The **HPX** has 11 tabbed menu titles and multiple submenu items as illustrated below. The **HPX** also has 1 'hot menu' subset of commonly adjusted menu items. They can be quickly accessed from the main measurement screen by pressing the **MEAS** key multiple times to access and tab right, or pressing the **ESC** key multiple times to tab left through the hot menu cells. Refer to Chapter Three for additional definitions and information on the keypad and menu items.

|                |  |
|----------------|--|
| Hot Menu Items |  |
|----------------|--|

**Note:** Only one "Threshold, Width and Holdoff" will be listed in the Hot Menus at a time. Log" is also listed, and is used to access data storage if no log file is currently open, or display log or grid file if open. Finally, either "Gain" or "AGC" will be displayed, depending on the current measurement mode selected.

### Start >>

| PRB        | CAL      | DISP            | TUNE           | GT1         | GT2         | GT3         | SETUP         |
|------------|----------|-----------------|----------------|-------------|-------------|-------------|---------------|
| ZERO PROBE | MAT      | VIEW            | MEASURE MODE   | START       | WIDTH 2     | HOLD 3      | OPEN          |
| TYPE       | MATL 1PT | DELAY (B-START) | POLARITY       | WIDTH 1     | HOLD 2      | THRESHOLD 3 | SAVE          |
|            | MATL 2PT | RANGE (B-DEPTH) | PULSE          | THRESHOLD 1 | THRESHOLD 2 |             | DELETE        |
|            | VELOCITY | (B-SCAN SPEED)  | PULSER VOLTAGE |             |             |             | DEFAULT SETUP |
|            |          | UNITS           | DAMPING        |             |             |             |               |
|            |          | BACKLIGHT       | GAIN           |             |             |             | LANGUAGE      |
|            |          | CONTRAST        | AGC            |             |             |             |               |
|            |          | RECT WAVE       | AGC MAX        |             |             |             |               |
|            |          | DETECT MARK     | TDG SLOPE      |             |             |             |               |
|            |          |                 | TDG START      |             |             |             |               |

>> End

| DATA            | UTILS        | XFER           |
|-----------------|--------------|----------------|
| NEW             | AUTO FIND    | UPGRADE GAUGE  |
| EDIT            | SCAN MODE    | CAPTURE VIEWER |
| OPEN            | ALARM        | ABOUT          |
| CLOSE           | ALARM HIGH   |                |
| DELETE ONE FILE | ALARM LOW    |                |
| DELETE ALL DATA | DIFFERENTIAL |                |
|                 | KEY CLICK    |                |
|                 | SET DATE     |                |
|                 | SHOW DATE    |                |

## 2.3 Selecting the Transducer Type





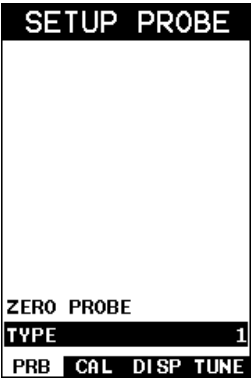

The first step for using the **HPX** is to select the transducer type. There are 2 different types; contact and delay line. The contact options consist of 1/8" to 1" diameters and 1-10 MHz frequencies, as well as a custom 500 kHz delay line transducer as the primary transducer option. The combination of these options will satisfy a variety of application scenarios. Selecting the type will load a default setup for that specific transducer to use as a starting point for fine tuning the final setup. **Note:** Once the transducer has been selected/loaded, the **HPX** will retain the selection and any modifications when the **HPX** is powered on/off. The transducer type will only change when another option has been selected. Therefore, if you have previously gone through this section and selected the appropriate setup, proceed to the next section.





The following steps outline transducer selection:

### Selecting the Transducer Type



```
SETUP PROBE
ZERO PROBE
TYPE 1
PRB CAL DISP TUNE
```

- 1) Press the  key to power up the **HPX**.
- 2) Press the  key once to activate the menu items tab. Press the  key multiple times to tab right and the  key multiple times to tab left until the **PRB** menu is highlighted and displaying the submenu items.
- 3) Press the  and  arrow keys to scroll through the sub menu items until **TYPE** is highlighted.
- 4) Press the  key to display the **Probe Type List**.

- 5) Press the  and  arrow keys multiple times to scroll through the list and highlight the correct type.
- 6) Press the  key to display the confirmation screen.
- 7) Press the  key to select the probe type and return to the menu screen, or  to cancel selecting the material type.

## 2.4 Probe Zero & Calibration

The next steps are to perform a probe zero and calibrate the **HPX** to a specific material type. If the sound velocity is unknown, the **HPX** can be calibrated to a known thickness sample. This demo will briefly explain both of these techniques.

**Note:** *The 'auto zero' option with 500 kHz delay line transducer will be demonstrated in this section. Refer to page 32 for additional zero/calibration options.*

The procedure is outlined as follows:



### Performing an Auto Probe Zero (Off Block)



#### WARNING!

BE SURE TO DO A  
PROBE ZERO BEFORE  
MEASURING



!

OK

- 1) Be sure all couplant has been removed from the face of the transducer.
- 2) Press the  key once to activate the menu items tab. Press the  key multiple times to tab right and the  key multiple times to tab left until the **PRB** menu is highlighted and displaying the submenu items.

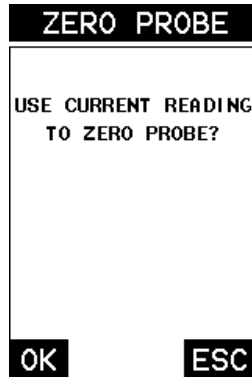
- 3) Press the  and  arrow keys multiple times to scroll through the sub menu items until **ZERO PROBE** is highlighted.



- 4) Press the  key to display the confirmation screen.
- 5) Press the  key to complete the probe zero process, or  key to cancel performing the probe zero process.
- 6) Proceed to the calibration section.





**Note:** *The value that is displayed will change depending on the current velocity setting in the **HPX**. Disregard the number that is displayed. **It is not important.** What is important is accurately performing the steps outlined above to insure reliability of the probe zero calculation.*

## One Point Material Calibration

For the purposes of this quick start section, we'll only be covering the most common one point calibration option to determine the sound velocity of the test material. It would be very handy to carry a set of mechanical calipers to use in conjunction with the **HPX** for making physical measurements of materials to calibrate in the field:

### Using a Known Thickness







| CALIBRATE |               |
|-----------|---------------|
| MAT       | CUSTOM        |
| MATL 1PT  | 0.400         |
| MATL 2PT  | UNCAL         |
| VELOCITY  | 0.2331        |
| PRB       | CAL DISP TUNE |

- 1) Physically measure an exact sample of the material or a location directly on the material to be measured using a set of calipers or a digital micrometer, and if a calibration standard will not be used.
- 2) Apply a drop of couplant on the transducer and place the transducer in steady contact with the cal standard or test material. Be sure that the reading is stable and the repeatability indicator in the top left corner of the display is fully lit and stable. Press the  key once to activate the menu items tab. Press the  key multiple times to tab right and the  key multiple times to tab left until the **CAL** menu is highlighted and displaying the submenu items.
- 3) Use the  and  arrow keys to scroll through the sub menu items until **MATL 1PT** is highlighted.

| MATL 1PT |     |
|----------|-----|
| 0.400    |     |
| OK       | ESC |

- 4) Press the  key to display the **Digits Edit Box**.



- 5) Use the  and  arrow keys to scroll the highlighted value.
- 6) Press the  and  arrow keys to scroll the digit locations.
- 7) Repeat steps 5 & 6 until the known thickness value is correctly displayed.
- 8) Press the  key to calculate the velocity and return to the menu screen, or  to cancel the one point calibration.
- 9) Finally, press the  key to return to the measurement screen and begin making measurements.









**Note: CHECK YOUR CALIBRATION!** Place the transducer back on the calibration point. The thickness reading should now match the known thickness. If the thickness is not correct, repeat the steps above.

## 2.5 Measure

The **HPX** is now ready to measure. There are four different measurement view options, each with a specific purpose – Digits, RF, RECT, & B-Scan. The steps below outline how to toggle between the different view options:

### Selecting the Measure View

| SET DISPLAY  |        |
|--------------|--------|
| VIEW         | +RECT  |
| DELAY        | 0.000  |
| RANGE        | 1.214  |
| B-SCAN SPEED | 6      |
| UNITS        | IN HR  |
| BACKLIGHT    | ON     |
| CONTRAST     | 6      |
| RECT WAVE    | FILLED |
| DETECT MARK  | DOTS   |
| PRB          | CAL    |
| DISP         | TUNE   |

- 1) Press the  key once to activate the menu items tab. Press the  key multiple times to tab right and the  key multiple times to tab left until the **DISP** menu is highlighted and displaying the submenu items.
- 2) Use the  and  arrow keys to scroll through the sub menu items until **VIEW** is highlighted.
- 3) Use the  and  arrow keys to scroll the view options.
- 4) Once the desired view is displayed, press the  key to return to measurement mode.

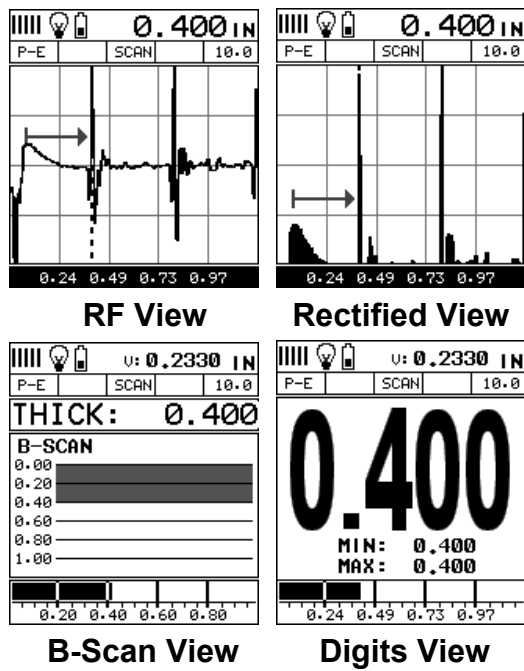

**DIGITS:** Displays the digital thickness value using a large font size. This view is useful when the **HPX** is intended for use as a basic thickness gauge.

**RF:** Displays the actual waveform signal, much like an oscilloscope, from the reflection of the opposite surface. This view shows both the positive and negative peaks, and is often used to fine tune the scope settings.

**RECT:** Displays a half waveform signal, either positive or negative, from the reflection of the opposite surface. The user can select the polarity or “phase” displayed. This is typically determined by first using RF view to select the most optimal polarity “phase”, setting the polarity, and switching to RECT view.

**BSCAN:** The Time Based B-Scan provides the user with a cross sectional view of the material being tested. This mode is useful when there is concern regarding the profile of the blind surface.







Once the view has been selected the **Delay** and **Range** of the screen will potentially need to be adjusted, considering the view selected is **RF** or **RECT**. Alternatively, if **BSCAN** was selected, the **B-Start** and **B-Depth** settings will potentially need to be adjusted as well. They are the same, with the exception of terminology; **Delay(B-Start) & Range(B-Depth)** and view. These items will be grouped together for the duration of this manual. Use the following steps to adjust these settings directly from the measurement screen as follows:

**Note:** *The **Delay (B-Start)** and **Range (B-Depth)** are also used to adjust the parameters of **Scan Bar** in digits & B-Scan views.*



### Adjusting Delay (B-Start) & Range (B-DEPTH)

|              |              |
|--------------|--------------|
| DELAY: 0.000 | RANGE: 0.500 |
| GAIN: 0.0    | THRESH1: 6   |
| START: 0.071 | WIDTH1: OFF  |
| HOLD2: OFF   | LOG: CLOSED  |







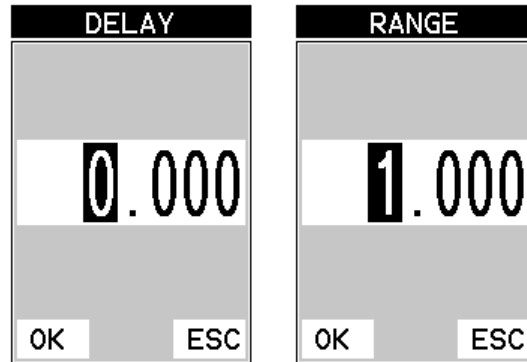

|              |              |
|--------------|--------------|
| DELAY: 0.000 | RANGE: 0.500 |
| GAIN: 0.0    | THRESH1: 6   |
| START: 0.071 | WIDTH1: OFF  |
| HOLD2: OFF   | LOG: CLOSED  |

- 1) Press the  key once to activate the measure menu items. Press the  key multiple times to move right and the  key multiple times to move left, until the either the **DELAY (START)** or **RANGE (DEPTH)** cell is highlighted.
- 2) Press the     arrow keys to scroll the **DELAY (START)** and **RANGE (DEPTH)** values.
- 3) Repeat steps **1 & 2** until the range is correctly being displayed.

Alternatively, the **DELAY (START)** and **RANGE (DEPTH)** values can be adjusted using the **Digit Edit Box** as follows:

- 4) Press the  key once to activate measure menu items. Press the  key multiple times to move right and the  key multiple times to move left, until the either the **DELAY (START)** or **RANGE (DEPTH)** cell is highlighted.



- 1) Press the  key to display the digits edit box.
- 2) Press the  and  arrow keys to scroll the highlighted value.
- 3) Press the  and  arrow keys to scroll the digit locations.
- 4) Repeat steps 2 & 3 until the **DELAY (START)** or **RANGE (DEPTH)** value is correctly displayed.
- 5) Press the  key to set the **DELAY (START)** and **WIDTH (DEPTH)** value and return to the measure screen, or  to cancel entering the **DELAY (START)** or **WIDTH (DEPTH)** value.
- 6) Finally, press the  key to return to the measurement screen and begin making measurements.

**Note:** The **DELAY (START)** & **WIDTH (DEPTH)** can also be adjusted from the tabbed menu item **DISP**. However, using the hot menu keys is the easiest method.

## CHAPTER THREE KEYBOARD, MENU, & CONNECTOR REFERENCE







### 3.1 Menu Key (Operation & Sub Menus)

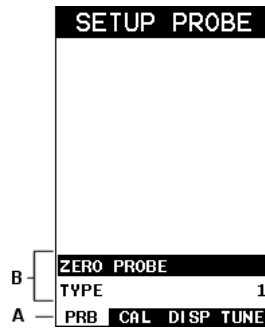

The **Menu** key activates the primary menu structure containing 8 menu tab groups. These tab groups then contain sub menu items, or functions. The sub menu items have been organized in tab groups according to how closely they are related to the individual tab group names. Let's first get familiar with how to move around in these tabs before continuing on to the sub menu functions. This procedure is outlined below:





### Activating and Getting Around in the Menu Items



- 1) Press the  key once to activate the menu items tab. Press the  key multiple times to tab right, and the  key multiple times to tab left until the desired tab group is highlighted and displaying the submenu items. The tab groups are illustrated above **(A)**.

Now that you're familiar with activating and moving around the tab groups, let's have a look at how to move around in the sub menu items as follows:

### Getting Around in the Sub Menu Items

- 1) Use the  and  arrow keys to scroll through the sub menu items until the desired menu item is highlighted. The sub menu items are illustrated in the diagram above **(B)**.
- 2) Depending on which menu item is highlighted, use the    keys to scroll the options or activate the **Digit Edit** and **List Box** options.

The sections to follow will provide the user with an explanation of the sub menu functions:

## 3.2 Probe – Menu

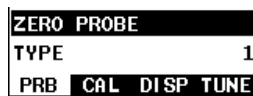

**ZERO PROBE:** The **HPX** is zeroed in much the same way that a mechanical micrometer is zeroed. If the **HPX** is not zeroed correctly, all of the measurements made using the **HPX** may be in error by some fixed value. The manual (on block) option is available for single contact transducer types in pulse echo (P-E) measurement mode, and the 'auto zero' option used with the 500 kHz delay line transducer. Refer to the section on page 32, for an explanation of this important procedure.

**TYPE:** Enables the user to select the type of transducer from a chart of transducer types. The options include 500 kHz delay line, or a variety of contact transducers 1-10 MHz and 1/8" to 1" diameters. A general setup will be load as a starting point with measure mode options available to the selected transducer type. Fine tuning and adjustments may be necessary depending on the application and material type. Refer to page 7 for a further explanation.

|          |               |
|----------|---------------|
| MAT      | STEEL <4340>  |
| MATL 1PT | UNCAL         |
| MATL 2PT | 0.4000        |
| VELOCITY | 0.2330        |
| PRB      | CAL DISP TUNE |

### 3.3 CAL – Menu

**MAT:** Select the material velocity from a chart of basic material types when a known sample thickness, or material velocity cannot be obtained. Refer to page 40 for further info.

**MATL 1PT:** Performs a single point calibration. This option allows the user to automatically calculate the velocity by entering a known sample thickness. Refer to page 36 for further info.

**MATL 2PT:** Performs a two-point calibration. This option allows the user to automatically calculate the velocity by entering a second known sample thickness. Refer to page 38 for further info.

**VELOCITY:** Function to calibrate the **HPX** by setting the velocity to a known material velocity. Refer to page 35 for further info.

| VIEW         | DIGITS        | VIEW         | BSCAN         |
|--------------|---------------|--------------|---------------|
| DELAY        | 0.779         | B-START      | 0.000         |
| RANGE        | 1.214         | B-DEPTH      | 1.000         |
| B-SCAN SPEED | 6             | B-SCAN SPEED | 6             |
| UNITS        | IN HR         | UNITS        | IN HR         |
| BACKLIGHT    | OFF           | BACKLIGHT    | OFF           |
| CONTRAST     | 10            | CONTRAST     | 10            |
| RECT WAVE    | FILLED        | RECT WAVE    | OUTLINE       |
| DETECT MARK  | DOTS          | DETECT MARK  | DOTS          |
| PRB          | CAL DISP TUNE | PRB          | CAL DISP TUNE |

### 3.4 DISP (display) – Menu

**VIEW:** Selectable RF wave, RECT (rectified), BSCAN (cross section), and DIGITS (large digits) view options. Refer to page 43 for further info.

**DELAY (B-START):** Provides the user the ability to change the A-Scan or Digits scanbar delay, and or start position of the B-SCAN view. Refer to page 52 for further info.

**RANGE (B-DEPTH):** Provides the user the ability to change the A-Scan or Digits scanbar Range, or the B-Scan overall depth of the viewable measurement area (zoom). Refer to page 53 for further info.

**B-SCAN SPEED:** Controls the speed of the time based B-Scan with an arbitrary scale of 0-10, with 10 being the fastest scrolling speed. Default speed set at 6. Refer to page 55 for further info.

**UNITS:** Toggle between English or Metric units. The readout will change from inches to millimeters (0.01" / 0.1mm), or (HR) high resolution (0.001" / 0.01mm).

**BACKLIGHT:** Selectable OFF, ON, AUTO, or INVERT backlight option. Refer to page 73 for further info.

**CONTRAST:** Adjustable display contrast for variable light conditions. Refer to page 73 for further info.

**RECT WAVE:** This option provides the user an outlined or filled view option when the display setting is in RECT (rectified) wave mode only. Refer to page 74 for further info.

**DETECT MARK:** Selectable graphics option for the point of detection on the waveform: Line, Box, Dots, None. Offers the user a graphics preference on how they prefer to view the detection on the waveform. Refer to page 75 for further info.

|                   |          |
|-------------------|----------|
| MEASURE MODE      | P-E      |
| POLARITY          | POSITIVE |
| PULSE             | THIN     |
| PULSER VOLTAGE    | 150      |
| DAMPING           | 300      |
| GAIN              | 10.0     |
| AGC               | 21       |
| AGC MAX           | 52.0     |
| TDG SLOPE         | 1.00     |
| TDG START         | 0.015    |
| PRB CAL DISP TUNE |          |

### 3.5 TUNE – Menu

**MEASURE MODE:** Toggles the measurement modes available to the transducer type selected. The modes are: pulse-echo (P-E) and echo-echo (E-E), depending on the transducer type selected. Refer to page 27 for further info.

**POLARITY:** The *HPX* uses zero crossing detection. The polarity toggles which stroke of the cycle the detection uses, either positive or negative. Refer to page 76 for further info.

**PULSE:** The *HPX* has adjustable pulse width options for both the 200 & 400 volt pulsers. The adjustable 400 volt tone burst pulser has tuned burst options at specific frequencies. These are selectable according to the transducer frequency for both



high penetration and resolution applications. The pulse width controls the duration of time the pulser is on. The options are (**Spike, Thin, and Wide**) for the 200 volt pulser, (**HV Spike, HV Thin, and HV Wide**) for the 400 volt pulser, and (**TB10MHz, TB5MHz, TB2MHz, TB1MHz, and TB.5MHz**) for the 400 volt tone burst option. Refer to page 78 for a further explanation.

**PULSER VOLTAGE:** The **HPX** has an adjustable 200 volt pulser (100, 150, 200 volts), a 400 high voltage pulser (200, 300, 400 volts), and a tunable high voltage 400 volt tone burst pulser (200, 300, 400 volts). Higher settings offer better penetration, while lower settings better resolution. Refer to page 79 for a further explanation.

**DAMPING:** Provides the user with multiple input impedances to match the impedance of the transducer and optimize overall transducer performance. Refer to page 80 for further info.

**GAIN:** The **HPX** has 110dB gain range from (-35 to 75 dB). This feature is used to increase/decrease the power or amplitude of the signal. Similar to turning the volume up or down on a stereo receiver. Refer to page 56 for further info.

**AGC:** The **HPX** is equipped with an automatic gain control and used for E-E (echo-echo) and E-EV (echo-echo verify) measurement modes. This feature automatically increases/decreases the power or amplitude of the signal to optimize the input to output signal ratio. Alternatively, the dynamic range of the AGC can be manually controlled using an arbitrary range of 1-20 clicks, the higher the number the larger the dynamic gain range. Refer to page 56 for further info.

**AGC MAX:** Allows control over the ‘maximum’ auto gain level setting. Allows for fine tuning of different style, frequency and diameter transducer settings. Refer to page 81 for further info.

**GAIN SLOPE (TIME DEPENDENT GAIN):** Similar to ‘time corrected gain’ but a linear gain ramp that increases/boosts the output of the **HPX** at a constant rate over time (dB per microsecond). Can be used in all measurement mode options to overcome attenuative materials and boost the signal output. Refer to page 82 for further info.

**TDG START:** Adjustable control of where the time dependent gain slope starts, and is only active in pulse-echo mode. In all other measurement modes the start value is automatically set. Refer to page 83 for further info.

### 3.6 GT1 – Menu

|             |             |
|-------------|-------------|
| START       | 0.085       |
| WIDTH 1     | OFF         |
| THRESHOLD 1 | 6           |
| GT1         | GT2 GT3 SET |

**START:** Gates allow the user to view signals within a specific measurement range, or sections of the waveform, while blocking others. This feature adjusts the start of the gate according to time/distance. Used in all measurement modes. Refer to page 62 for further info.

**GATE1 WIDTH:** This feature allows the user to set the overall width of the gate, in terms of distance, from the starting value of Gate1. Refer to page 62 for further info.

**THRESHOLD1:** Enables the user to set the sensitivity level of Gate1. The amplitude of the signal must reach or exceed the threshold level to detect and measure. Refer to page 62 for further info.

### 3.7 GT2 – Menu

|             |       |
|-------------|-------|
| WIDTH 2     | 0.771 |
| HOLD2       | 0.064 |
| THRESHOLD 2 | 7     |
| GT1         | GT2   |
| GT3         | SET   |

**GATE2 WIDTH:** This feature allows the user to set the overall width of the gate, in terms of distance, from the starting value of HoldOff2. Refer to page 62 for further info.

**HOLDOFF 2:** Provides the user with the ability to delay the starting point of Gate2 a specific distance from the first detection point found inside of the boundaries of the Gate 1 settings. If no detection is found, the Gate1 width value is used as a starting value for Gate2. Refer to page 62 for further info.

**THRESHOLD2:** Enables the user to set the sensitivity level of Gate2. The amplitude of the signal must reach or exceed the threshold level to detect and measure. Refer to page 62 for further info.

### 3.8 GT3 – Menu

|             |       |
|-------------|-------|
| HOLD3       | 0.007 |
| THRESHOLD 3 | 7     |
| GT1         | GT2   |
| GT3         | SET   |

**HOLDOFF 3:** Provides the user with the ability to delay the starting point of Gate3 a specific distance from the first detection point found inside of the boundaries of the Gate 2 settings. If no detection is found, the Gate2 width value is used as a starting value for Gate3. Refer to page 62 for further info.

**THRESHOLD3:** Enables the user to set the sensitivity level of Gate3. The amplitude of the signal must reach or exceed the threshold level to detect and measure. Refer to page 62 for further info.

### 3.9 SETUP – Menu

|               |         |
|---------------|---------|
| OPEN          |         |
| SAVE          |         |
| DELETE        |         |
| DEFAULT SETUP |         |
| LANGUAGE      | ENGLISH |
| GT1           | GT2     |
| GT3           | SET     |

**OPEN:** Displays a list of factory and user defined setups currently stored in memory. These setups can be recalled and used at any time. Refer to page 118 for further info.

**SAVE:** Provides the user with the ability to save a custom setup that has been modified or created by the user. Refer to page 119 for further info.

**DELETE:** Provides the user with the ability to delete specific setups previously save in memory. Refer to page 122 for further info.

**DEFAULT SETUP:** Loads a basic default setup. Use only as a last resort when the setups in the *HPX* have been corrupted and a computer is not accessible. Refer to page 124 for further info.

**LANGUAGE:** Provides the user the ability to select different languages for the *HPX*. Refer to page 125 for further info.

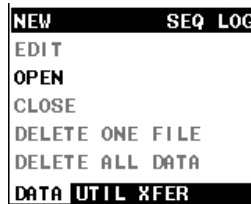

### 3.10 DATA – Menu

**NEW:** Allows the user the ability to create a new alpha numeric grid, or sequential log file with auto identifiers. It is equipped with custom parameters, rows, and columns depending on the user’s application reporting requirements. Refer to page 97 for further info.

**EDIT:** Gives the user the ability to change parameters of grid or sequential file previously saved. Note: Pre-defined coordinates cannot be changed once they have been created. Refer to page 112 for further info.

**OPEN:** This function provides the user with the ability to recall grids or sequential log files that currently exist in memory, from a list of grids. Refer to page 114 for further info.

**CLOSE:** Provides the user the ability to close a currently opened grid or sequential log file. Refer to page 116 for further info.

**DELETE ONE FILE:** This function provides the user with the ability to delete one individual grid or sequential log file from a list of multiple grids/files previously saved in memory. Refer to page 109 for further info.

**DELETE ALL DATA:** This function provides the user with the ability to delete all files currently stored in memory. Refer to page 110 for further info.

|                       |        |
|-----------------------|--------|
| <b>AUTO FIND</b>      |        |
| SCAN MODE             | ON     |
| ALARM                 | ON     |
| ALARM HIGH            | 0.350  |
| ALARM LOW             | 0.250  |
| DIFFERENTIAL          | OFF    |
| KEY CLICK             | QUIET  |
| SET DATE              | MMDDYY |
| SHOW DATE             | OFF    |
| <b>DATA UTIL XFER</b> |        |

### 3.11 UTIL (utilities) – Menu

**AUTO FIND:** Automatically locates and displays the detection point if the measurement is out of the viewable display area. Refer to page 84 for further info.

**SCAN MODE:** This function enables a high speed scan mode that increases the overall sample rate to 200 measurements per second (200Hz). Refer to page 85 for further info.

**ALARM:** Toggles alarm mode on, off, or audible. Refer to page 86 for further info.

**ALARM HIGH:** Gives the user the ability to set the high limit parameter. If the measurement exceeds this value, a red light will illuminate and sound the internal beeper. Refer to page 86 for further info.

**ALARM LOW:** Gives the user the ability to set the low limit parameter. If the measurement falls below this value, a red light will illuminate and sound the internal beeper. Refer to page 86 for further info.

**DIFFERENTIAL:** Gives the user the ability to set a nominal value and the **HPX** will display +/- the difference from the nominal value entered. Refer to page 88 for further info.

**KEY CLICK:** Give the user the ability to set the level of the key press beeper, OFF, QUIET, or LOUD. Refer to page 90 for further info.

**SET DATE:** Gives the user the ability to set the internal date and time stamp in the **HPX**. Refer to page 91 for further info.

**SHOW DATE:** Gives the user the ability to display the date and time in the waveform area of the **HPX**. The options are OFF, DATE, TIME, BOTH. Refer to page 92 for further info.

|                       |           |
|-----------------------|-----------|
| <b>UPGRADE GAUGE</b>  |           |
| CAPTURE VIEWER        |           |
| ABOUT                 | DEV 3.01R |
| <b>DATA UTIL XFER</b> |           |

### 3.12 XFER (transfer) – Menu

**UPGRADE GAUGE:** Enables the user the ability to upgrade the **HPX** to the most current firmware revision. Latest version posted on [www.dakotaultrasonics.com](http://www.dakotaultrasonics.com).

**CAPTURE VIEWER:** Enables the user to view all the captured (.tif) files stored in the **HPX** on the gauge display. Refer to page 94 for further info.

**ABOUT:** Provides the user with Dakota Ultrasonics contact information and the **HPX** firmware version. Refer to the Dakota Ultrasonics web site for information on the latest firmware versions available for download.

### 3.13 CLR (clear) Key



The primary function of the **CLR** key is to clear a measurement, or set an *obstruct* (obstruction) in a grid or sequential log. It is also used as a backspace in an **Alpha Edit Box**. If a user has already saved a measurement in a cell location, use this key to clear the measurement at any time.

### 3.14 MEAS (measurement mode) Key



The **MEAS** key displays the main measurement screen, as well as advances the cell cursor forward/right in the Hot Menu fields.

**Note:** *(color version only) – If the “Landscape” feature is enabled and currently active, pressing the **MEAS** key will toggle back to portrait view and display the Hot Menu items.*

### 3.15 OK Key



The primary function of the **OK** key is confirmation of a change or selection. It also toggles the Hot Menu area to a large digits display view in measurement mode. When displaying a grid or sequential log in the Hot Menu area, the **OK** key toggles a “go to row” digits edit box to advance to a specific cell location.

**Note:** *When the “landscape” feature is enabled, the **OK** key toggles the screen rotation 90 degrees right or left, depending on the setting selected.*

### 3.16 ESC Key



The **ESC** key is used in conjunction with the **MENU**, **MEAS**, and **EDIT** functions to move the cursor left, or as an escape from function. When viewing a grid or sequential log in the Hot Menu area, the **ESC** key toggles the display options: Digits, RF, RECT, and B-Scan views.

### 3.17 Arrow Keys



The **Arrow Keys** are used to navigate through the menus, increase/decrease values, and toggle specific function keys.

### 3.18 ENTER key



The **ENTER** key is used in the overall menu selection process to activate list and edit boxes, and display and save measurements to grid or sequential file.

### 3.19 MULTI MODE Key



The **MULTI MODE** key opens a measurement mode screen, listing all the modes available to the transducer type selected. The measure modes possible are: pulse-echo (P-E), echo-echo (E-E), and (E-EV) echo-echo verify (triple-echo). All or a combination of these modes will be available to a given transducer type. An additional menu item “**capture To File**” can also be accessed and performed from this screen. This feature captures and stores the last screen viewed to a .tif file.

### 3.20 ON/OFF Key



The **ON/OFF** key simply powers the unit either **ON** or **OFF**. **Note:** *Unit will automatically power off when idle for 5 minutes. All current settings are automatically saved prior to powering off.*

### 3.21 Top & Bottom End Caps

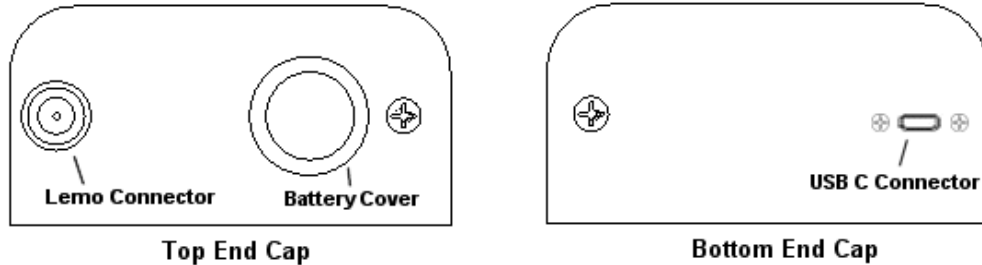

The top & bottom end panels are where all connections are made to the **HPX**. The diagram above shows the layout and description of the connectors:

#### Transducer Connectors

Refer to Diagram: The transducer connector and battery cover/probe zero disk are located on the **HPX** top end cap. The transducer connector type is a Lemo “00”.

#### Probe Zero Disk & Battery Cover

The Battery cover is the large round disk shown in the diagram. Simply remove the cover when replacing the batteries (3 AA cells). The battery polarity reference is indicated on the back label of the **HPX**.

**Note:** *Rechargeable batteries can be used however they must be recharged outside of the unit in a stand-alone battery charger.*

**Note:** *This same disk is also used as a probe zero disk. When performing a manual probe zero function, simply place the transducer on disk making firm contact.*

#### USB-C Connector

The **USB-C** connector, located on the bottom end cap, is a mini type C female connector. It is designed to connect directly from the **HPX** to a standard USB type A port on a PC. The cable supplied with the **HPX** is a USB type C to a USB type A (pt# N-003-0330).

**Note:** *This connector is also used to upgrade the **HPX** with the latest version of firmware.*

## **CHAPTER FOUR**

### **PRINCIPALS OF ULTRASONIC MEASUREMENT**

#### **4.1 Time versus thickness relationship**

Ultrasonic thickness measurements depend on measuring the length of time it takes for sound to travel through the material being tested. The ratio of the thickness versus the time is known as the sound velocity. In order to make accurate measurements, a sound velocity must be determined and entered into the instrument.

The accuracy of a thickness measurement therefore depends on having a consistent sound velocity. Some materials are not as consistent as others and accuracy will be marginal. For example, some cast materials are very granular and porous and as a result have inconsistent sound velocities.

While there are many different ultrasonic techniques to measure thickness, which will be discussed below, all of them rely on using the sound velocity to convert from time to thickness.

#### **4.2 Suitability of materials**

Ultrasonic thickness measurements rely on passing a sound wave through the material being measured. Not all materials are good at transmitting sound. Ultrasonic thickness measurement is practical in a wide variety of materials including metals, plastics, and glass. Materials that are difficult include some cast materials, concrete, wood, fiberglass, and some rubber.

#### **4.3 Range of measurement and accuracy**

The overall measurement capability, based on wide variety of material types, is determined by the consistency/homogeneity of the material being measured.

The thickness range will depend on the material type, technique used, and the type and frequency of the transducer.

The accuracy will be based on the consistency of the materials velocity. The more consistent/homogeneous the material is, the better the accuracy.

#### **4.4 Couplant**

All of our equipment, given our frequency range, require some type of medium to effectively transfer the sound generated from the transducer into the test material. Typically a high viscosity liquid is used as the medium. The frequencies used, megahertz (MHz), do not travel through air efficiently. By using a liquid couplant between the transducer and test material, the greater amount of ultrasound transferred.

#### **4.5 Temperature**



Temperature has an effect on sound velocity. The higher the temperature, the slower sound travels in a material. High temperatures can also damage transducers and present a problem for various liquid couplants.

Since the sound velocity varies with temperature it is important to calibrate at the same temperature as the material being measured.

**Normal temperature range**

Most standard transducers will operate from 0°F to 120°F.

**High temperature measurements**

Special transducers and couplants are available for temperatures above the normal range. It is necessary to cool the transducer, by submerging it in water, between measurements at high temperatures.

**Modes and temperature errors**

In addition to errors caused by velocity changing, transducer heating & cooling, some modes (measurement techniques) will be affected more than others. For example, pulse-echo mode will have larger errors than a multiple-echo technique. However, there's a trade-off, as multiple echoes are harder to produce in materials at high temperatures.

**4.6 Measurement Modes**

In this section we will discuss the different measurements modes the **HPX** is capable of operating in, the transducers required, and the reasons for using specific modes:

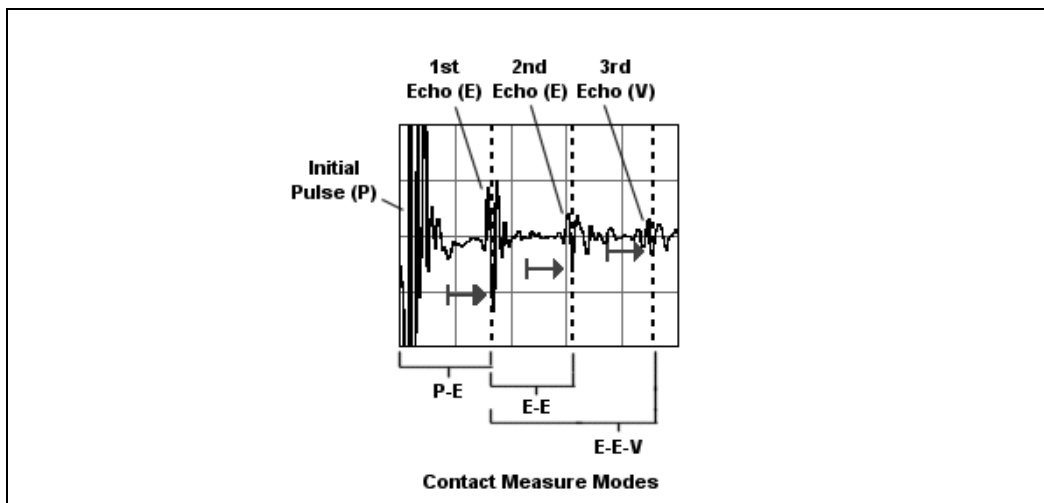

**Pulse-Echo Mode (P-E) – Contact Style Transducer**

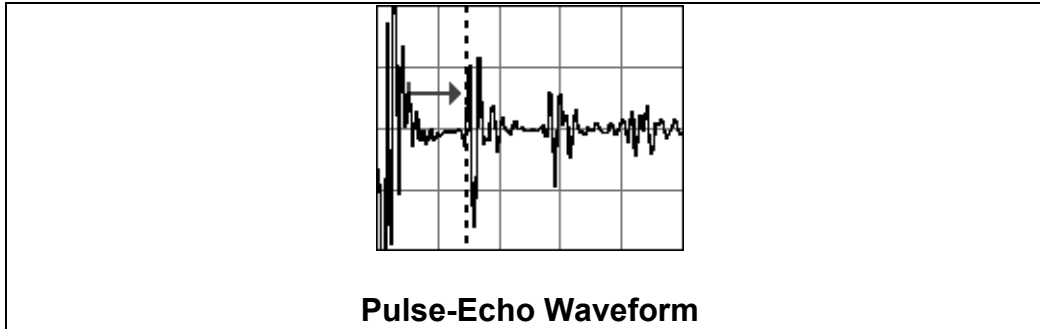

Pulse-echo mode measures from the initial pulse (sometimes referred to as an artificial zero) to the first echo (reflection). The transducer is placed on a reference disk, located on the top of the **HPX**, and the zero function is executed to establish a zero point for the transducer. Surface coatings and temperature variations will produce errors in this mode. As pulse-echo mode only requires a single reflection/echo, it is the best mode for measuring thicker attenuative materials. Used for general material thickness requirements, and used in conjunction with a single element contact style transducer.

**Note:** *The 500 kHz delay line transducer also uses pulse-echo (P-E) mode.*

### **Echo-Echo Mode (E-E) – Contact Style Transducer**

Echo-echo mode measures between two echoes (reflections). This measure mode is commonly used to eliminate errors temperature gradients when used with a single element contact style transducer. Since two echoes are needed for measurement, a possible disadvantage would include granular and attenuative materials where multiple echoes cannot be produced. Error from paint or surface coating will also be eliminated. Used for general material thickness requirements, and used in conjunction with a single element contact style transducer.

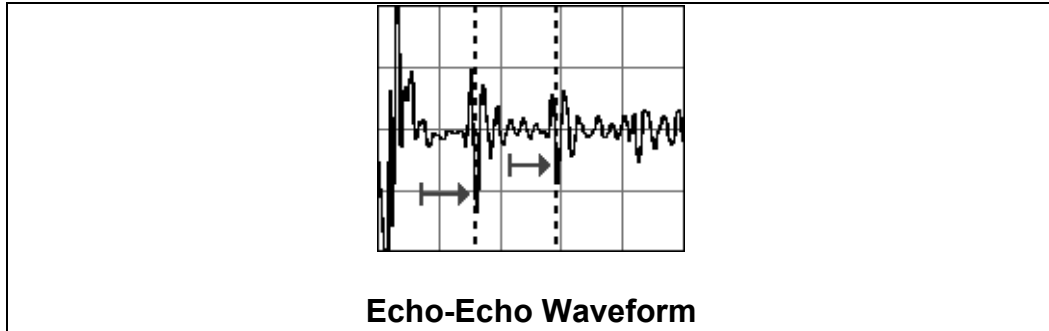

**Echo-Echo Verify Mode (E-E-V) – Contact Style Transducer**

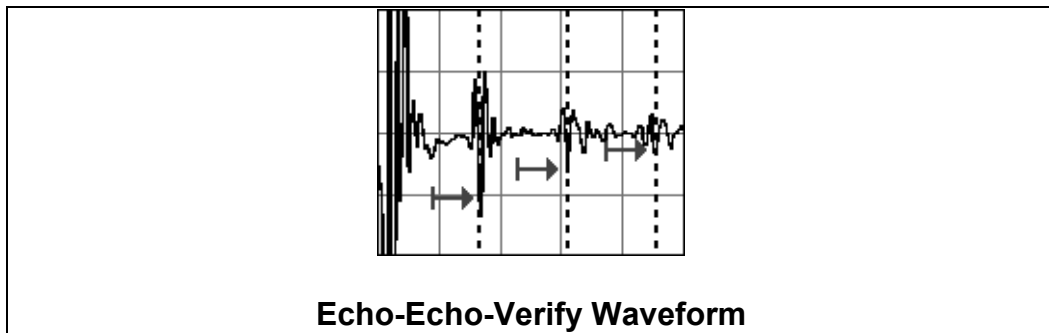

Echo-echo verify mode measures between three reflections. Similar to E-E mode, this technique is commonly used to eliminate errors from surface coatings and also as verification of echo-echo mode, as it compares the 1<sup>st</sup> & 2<sup>nd</sup> to the 2<sup>nd</sup> & 3<sup>rd</sup> echoes to verify they're both measuring on the same cycle, thus providing the user an additional level of confidence. The disadvantage is three reflections are needed for measurement, and not always easy to produce when measuring attenuative or thick materials. Used for general material thickness requirements, and used in conjunction with a single element contact style transducer.

## CHAPTER FIVE MAKING MEASUREMENTS

The steps involved in making measurements are detailed in this section. The following sections outline how to setup and prepare your **HPX** for field use.

Both the 500 kHz delay line and contact style transducers can be used with the **HPX**. The low frequency 500 kHz transducer uses a modified 'auto zero' method to account for the rubber delay line. All standard contact transducers require a manual zero using the disk at the top of the gauge (battery disk). Both transducer types can be zeroed using any 'standalone' test specimen and performing a 'one point calibration' using the 'second point' option in the CAL menu (MATL 2PT). This can only be done in the pulse-echo (P-E) measurement mode. The zero procedure compensates for variations in hardware and transducers.

In all modes the sound velocity must be determined. The sound velocity is used to convert the transit time to a physical length. The sound velocity can be selected from a material chart in the manual, selected from a material list in the **HPX**, or for greater precision determined from a mechanically measured sample of the test material. To enter the velocity from a table, look up the material on the chart in the appendix of this manual and refer to the section below on Calibration to a Known Velocity. To determine the velocity of a single sample, refer to the Material Calibration section on page 36.

For more accuracy over a smaller thickness range, a two-point calibration can be performed using a minimum and maximum test sample representative of the thickness range. This procedure is outlined on page 38.





### 5.1 Selecting Transducer Type

The first step in using the **HPX** is to select the transducer/probe type from a list in the gauge. This will load the parameters for the type selected, which can be used as a general starting point. All of the types in the list, with the exception of the '500 kHz delay line' type, were setup for mild carbon steel. The settings were also tuned to represent the effective measuring ranges, depending on the measure mode active. The procedure for selecting the probe type is outlined below as follows:

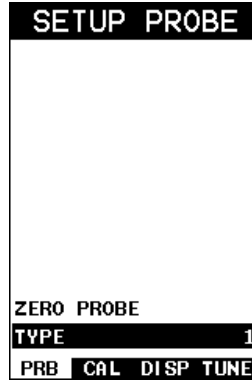

**Note:** *Once the transducer type has been selected, the **HPX** will store and recall this transducer type every time the **HPX** is powered on/off. The type will only change if the user physically selects another type from the list, or selects a previously saved setup. Therefore, if you have previously gone through this section and selected the transducer, proceed to the next section.*

#### Transducer Type

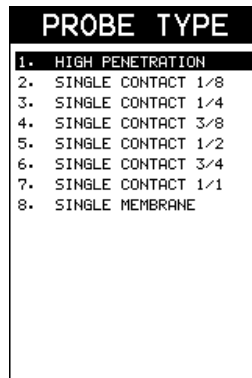

- 1) Press the  key once to activate the menu items tab. Press the  key multiple times to tab right and the  key multiple times to tab left until the **PRB** menu is highlighted and displaying the submenu items.
- 2) Use the  and  arrow keys to scroll through the sub menu items until **TYPE** is highlighted.



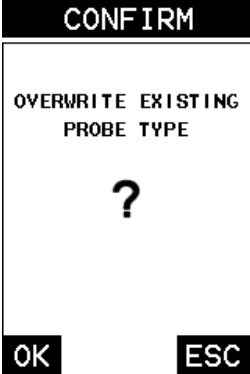

- 3) Press the  key to display the probe type list.
- 4) Use the  and  arrow keys to scroll through the list until the correct type is highlighted.

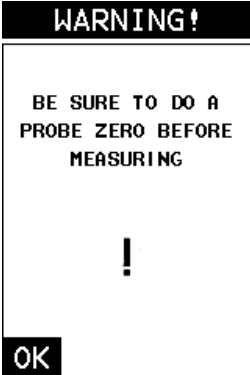

5) Press the  key to display the confirmation screen.



6) Press the  key to display the warning screen, and the  once again to return to the measurement screen, or  to cancel selecting the probe type.



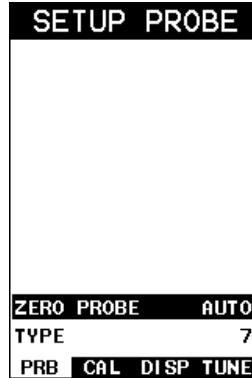

## 5.2 Probe zero

All the transducer types in the HPX will require either a 'manual (On Block)' zero (contact style probes), or an 'auto (Off Block)' zero (500 kHz delay line probe) if pulse-echo measure mode will be used. If a contact transducer type was selected and will only be used in the echo-echo measure mode, proceed to the next section. The steps to perform a zero are outlined below as follows:



### Auto Zero (Off Block)



**Note:** Couplant must be removed from the face of the probe and the transducer 'not' in contact with any material.

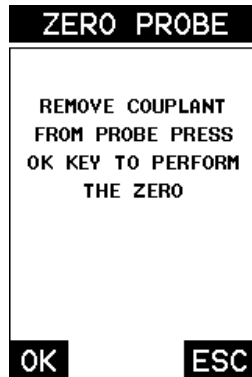



- 1) Press the  key to activate the menu items tab. Press the  key multiple times to tab right and the  key multiple times to tab left until the **PRB** menu is highlighted and displaying the submenu items.
- 2) Press the  and  arrow keys to scroll through the sub menu items until **ZERO PROBE** is highlighted.



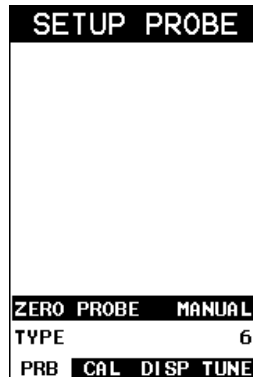



- 3) Press the  key to display the confirmation screen.
- 4) Press the  key to perform the auto zero and return the measurement screen, or  key to cancel the auto zero procedure.
- 5) Proceed to the calibration section.

## Manual Zero (On Block)

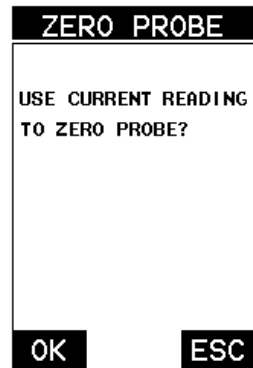

- 1) Apply a drop of couplant on the transducer and place the transducer in steady contact with the probe zero disk. Obtain a steady reading.
- 2) Press the  key to activate the menu items tab. Press the  key multiple times to tab right and the  key multiple times to tab left until the **PRB** menu is highlighted and displaying the submenu items.
- 3) Press the  and  arrow keys to scroll through the sub menu items until **ZERO PROBE** is highlighted.



- 4) Press the  key to display the confirmation screen.
- 5) Press the  key to complete the probe zero function, or  key to cancel the probe zero procedure.
- 6) Remove the transducer from the probe zero disk and proceed to the calibration section.



**Note:** *The value that is displayed will change depending on the current velocity setting in the **HPX**. Disregard the number that is displayed. **It is not important.** What is important is accurately performing the steps outlined above to insure reliability of the probe zero calculation.*

### 5.3 Material Calibration

In order for the **HPX** to make accurate measurements it must be set to the correct sound velocity of the material being measured. Different types of materials have different sound velocities. For example, the velocity of sound through steel is about 0.233 inches per microsecond, versus that of aluminum which is about 0.248 inches per microsecond, and even fiberglass which is much slower. If the gauge is not set to the correct sound velocity, all measurements may be in error.

The **One Point** calibration is the simplest and most commonly used calibration method - optimizing linearity over large ranges. The **Two Point** calibration allows for greater accuracy over smaller ranges by calculating the probe zero and velocity. The **HPX** provides four simple methods for either manually setting a known velocity, or allowing the **HPX** to calculate the sound-velocity outlined below:





#### Known Velocity

If the material velocity is known, it can be directly entered into the **HPX**. The steps for entering the velocity are outlined below:









**Entering Known Velocity**

**CALIBRATE**

|          |               |
|----------|---------------|
| MAT      | STEEL <4340>  |
| MATL 1PT | UNCAL         |
| MATL 2PT | UNCAL         |
| VELOCITY | 0.2330        |
| PRB      | CAL DISP TUNE |

- 1) Press the  key once to activate the menu items tab. Press the  key multiple times to tab right and the  key multiple times to tab left until the **CAL** menu is highlighted and displaying the submenu items.
- 2) Use the  and  arrow keys to scroll through the sub menu items until **VELOCITY** is highlighted.



- 3) Press the  key to display the **Digits Edit Box**.
- 4) Press the  and  arrow keys to scroll the highlighted value.
- 5) Press the  and  arrow keys to scroll the digit locations.
- 6) Repeat steps **4 & 5** until the velocity number is correctly displayed.
- 7) Press the  key to set the velocity and return to the menu screen, or  to cancel entering the velocity.
- 8) Finally, press the  key to return to the measure screen and begin making measurements.

## Known Thickness

When the material velocity is unknown, or accuracy is critical, the sound velocity can be calculated using one or two known thicknesses locations on the test material. As previously stated, the **HPX** has a one or two point calibration option. The one point calibration option is most suited for linearity over large ranges. It's best to calibrate on the thickest point of the measurement range, or close to it, to minimize the error.





For example, if the measurement range is .100" (2.54mm) to 1.0" (25.4mm), the user should calibrate on a known thickness close to 1.0" (25.4mm). The procedure to perform a 'one point' calibration is outlined below as follows:

**Note:** *It's always handy to carry a set of mechanical calipers to use in conjunction with the HPX for calibration in the field.*









### One Point Calibration

| CALIBRATE       |               |
|-----------------|---------------|
| MAT             | CUSTOM        |
| <b>MATL 1PT</b> | <b>0.5000</b> |
| MATL 2PT        | UNCAL         |
| VELOCITY        | 0.2324        |
| PRB             | CAL DISP TUNE |

**Note:** *If a contact style transducer was selected, be sure a probe zero has been performed prior to performing the calibration procedure.*

- 1) Physically measure an exact sample of the material, or a location directly on the material to be measured, using a set of calipers or a digital micrometer.
- 2) Apply a drop of couplant on the transducer and place the transducer in steady contact with the sample or actual test material. Be sure that the reading is stable and the repeatability indicator, in the top left corner of the display, is fully lit and stable. Press the  key once to activate the menu items tab. Press the  key multiple times to tab right and the  key multiple times to tab left until the **CAL** menu is highlighted and displaying the submenu items.
- 3) Use the  and  arrow keys to scroll through the sub menu items until **MATL 1PT** is highlighted.







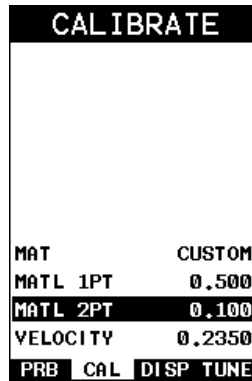

- 4) Press the  key to display the **Digits Edit Box**.
- 5) Press the  and  arrow keys to scroll the highlighted value.
- 6) Press the  and  arrow keys to scroll the digit locations.
- 7) Repeat steps **5 & 6** until the known thickness value is correctly displayed.
- 8) Press the  key to calculate the velocity and return to the menu screen, or  to cancel the one point calibration.
- 9) Finally, press the  key to return to the measurement screen and begin taking readings.

**Note: CHECK YOUR CALIBRATION!** Place the transducer back on the calibration point. The thickness reading should now match the known thickness. If the thickness is not correct, repeat the steps above.



When additional accuracy is needed over a smaller measurement range, a two point calibration can be used. For example, if the measurement range was .080" (2.03mm) to .250" (6.35mm), it's optimal to select two points close to the minimum and maximum thicknesses range. When a two point calibration is performed, the **HPX** calculates the zero and the velocity. The following steps outline this procedure:



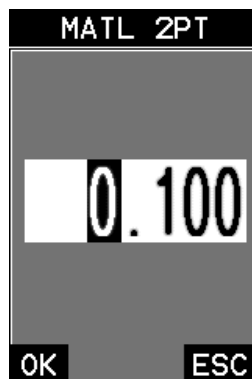

### Two Point Calibration



- 1) Physically measure an exact sample of the material or a location directly on the material to be measured using a set of calipers or a digital micrometer.
- 2) Apply a drop of couplant on the transducer and place the transducer in steady contact with the sample or actual test material. Be sure that the reading is stable and the repeatability indicator, in the top left corner of the display, is fully lit and stable. Press the  key once to activate the menu items tab. Press the  key multiple times to tab right and the  key multiple times to tab left until the **CAL** menu is highlighted and displaying the submenu items.
- 3) Use the  and  arrow keys to scroll through the sub menu items until **MATL 2PT** is highlighted.



- 4) Press the  key to display the **Digits Edit Box**.
- 5) Press the  and  arrow keys to scroll the highlighted value.





- 6) Press the  and  arrow keys to scroll the digit locations.
- 7) Repeat steps **5 & 6** until the known thickness value is correctly displayed.
- 8) Press the  key to calculate the zero/velocity and return to the menu screen, or  to cancel the one point calibration.
- 9) Finally, press the  key to return to the measurement screen and begin taking readings.

**Note: CHECK YOUR CALIBRATION!** Place the transducer back on the calibration point. The thickness reading should now match the known thickness. If the thickness is not correct, repeat the steps above.

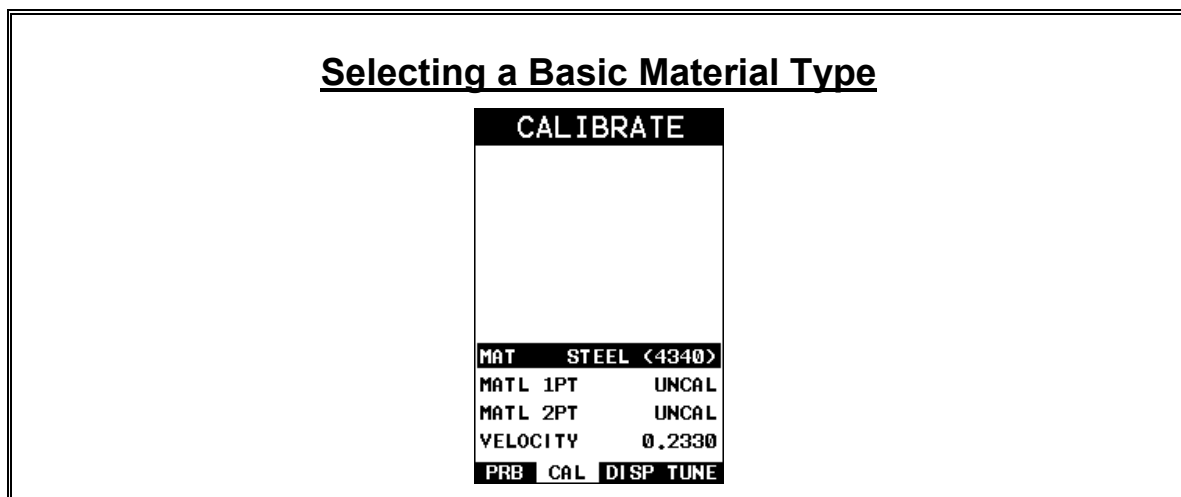

## Basic Material Type



If the material velocity is unknown, and a sample thickness cannot be taken from the material, the user may opt to select a basic material type from the list of materials in the gauge, or from a chart. These are 'approximate' velocity values only, but for general inspection may be all that's required. Use these values only if a close approximation is acceptable. Follow the steps below to select a basic material type:







- 1) Press the  key once to activate the menu items tab. Press the  key multiple times to tab right and the  key multiple times to tab left until the **CAL** menu is highlighted and displaying the submenu items.
- 2) Use the  and  arrow keys to scroll through the sub menu items until **MAT** is highlighted.

| MATL TYPE          |        |
|--------------------|--------|
| 18. MONEL          | 0.2110 |
| 19. NICKEL         | 0.2220 |
| 20. NYLON          | 0.1060 |
| 21. PLATINUM       | 0.1560 |
| 22. PLEXIGLASS     | 0.1060 |
| 23. POLYSTYRENE    | 0.0920 |
| 24. PVC            | 0.0940 |
| 25. QUARTZ GLASS   | 0.2260 |
| 26. RUBBER, VULCAN | 0.0910 |
| 27. SILVER         | 0.1420 |
| 28. STEEL (1020)   | 0.2320 |
| 29. STEEL (4340)   | 0.2330 |
| 30. STEEL, STAIN.  | 0.2230 |
| 31. TEFLON         | 0.0540 |
| 32. TIN            | 0.1310 |
| 33. TITANIUM       | 0.2400 |
| 34. TUNGSTEN       | 0.2040 |

- 3) Press the  key to display the list of material types.
- 4) Press the  and  arrow keys to scroll through the material list until the appropriate material is highlighted.

| CONFIRM   |   |
|---|---|
| OVERWRITE<br>CURRENT<br>VELOCITY  |   |
|  |  |

- 5) Press the  key to display the confirmation screen.
- 6) Press the  key to overwrite the velocity, or  key to cancel selecting a material type.

7) Finally, press the  key to return to the measurement screen and begin taking readings.



## CHAPTER SIX DISPLAY VIEW OPTIONS

The **HPX** has four different display options; Digits, RF, RECT and B-Scan. All views provide a digital thickness readout, and alarm limit tolerances if active. A key feature of the **HPX** is the A-Scan waveform display. The waveform is a graphical representation of the sound reflections, similar to an oscilloscope. Consider standing at the base of a canyon and screaming “Hello There”. After a brief delay, you will here multiple echoes, “Hello There’s” repeated back to you. The waveform displays the sine waves showing the amplitude of the signal received on the vertical (Y) axis, and thickness/depth on the horizontal (X) axis. It’s very useful to have a visual presentation to make adjustments to the features of the scope, as well as an understanding of where the detection is occurring. Confirmation that the detection is occurring in the right location, while making adjustments to the gates, gain and threshold makes the **HPX** a versatile instrument.

The B-Scan display option can also be useful when doing short scans of a surface area, and viewing the cross section of the test material. It provides a convenient way of visually profiling, or drawing a picture of, the blind surface of the test material during a scan. The graphical scan bar represents the thickness of the material direct beneath the probe. The display options are outline in the chapter as follows:

### 6.1 Display Views

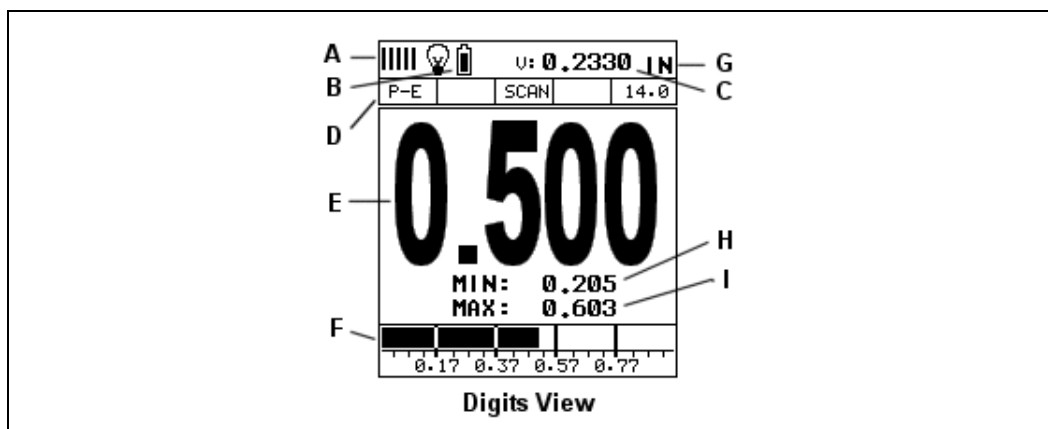

#### Digits

The Digits view is a basic digital thickness gauge look and feel. The larger digits make it much easier for the operator to monitor the thickness readings. The Scan Bar has also been added to the Digits view to provide the user with yet another visual tool for easily monitoring changes in thickness readings due to internal voids or lamination issues.

The following is a list of the viewable features on the display:

- A. **Repeatability/Stability Indicator** – This indicator should be commonly used in conjunction with the digital thickness value displayed. When all the vertical bars are fully illuminated and the last digit on the digital thickness value is stable, the **HPX** is reliably measuring the same value multiple times per second.
- B. **Battery Icon** – Indicates the remaining amount of battery life.
- C. **Velocity** – The current material velocity value setting. Displayed in English or Metric units, depending on current units setting.
- D. **Feature Status Bar** – Indicates the features currently enabled and in use, in the following order:
  - Measurement Mode (P-E, E-E, E-EV)
  - Differential Mode (ON/OFF)
  - High Speed Scan Mode (ON/OFF)
  - Alarm Mode (ON/OFF/AUDIBLE)
  - Gain Setting (Manual & Automatic (AGC))
- E. **Digital Material Thickness Value** – Extra large font size for viewing ease.
- F. **Scan Bar** – Another view of material thickness in a deflection style horizontal bar. Another visual tool offering the ability to see thickness changes during high speed scans.
- G. **Units** – The current measurement units (English, Metric).
- H. **Minimum Material Thickness** – Part of the scan feature. Displays the minimum thickness value found during a scan.
- I. **Maximum Material Thickness** – Part of the scan feature. Displays the maximum thickness value found during a scan.

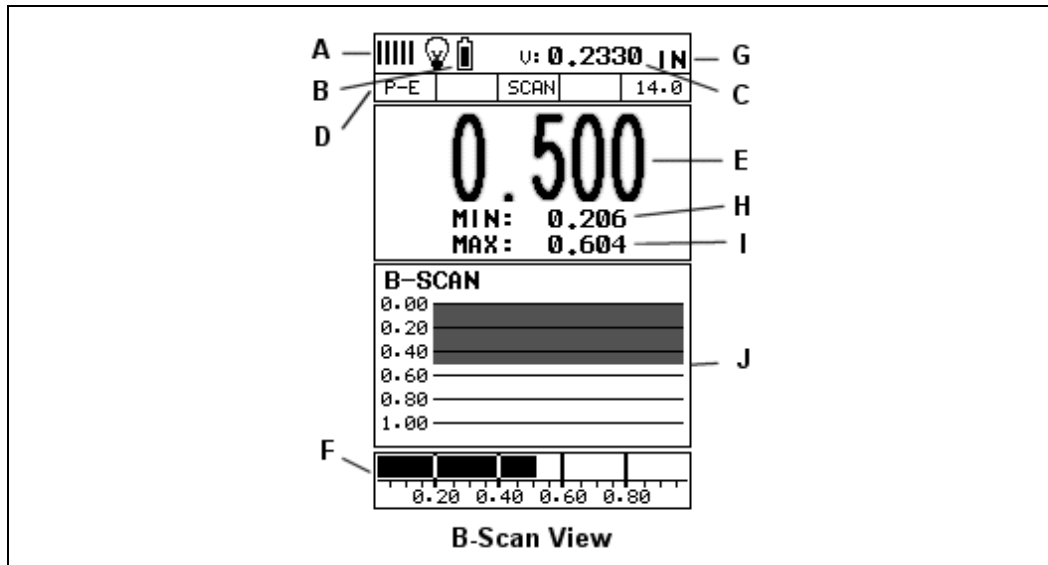

## B-Scan

The B-Scan displays a time based cross section view of test material. This view is commonly used to display the contour on the blind, or opposite surface of a test material or part. The solid black rectangle in the diagram at location K represents the cross section, or side view of the material. The B-Scan view is equipped with an adjustable speed that it will draw to the display.

**Note:** The measurement range on the display should be set wide enough to include the maximum material thickness on the display. If the range is set less than the maximum thickness of the material, the opposite surface will not be in view.

The following is a list of the viewable features on the display:

- A. **Repeatability/Stability Indicator** – This indicator should be commonly used in conjunction with the digital thickness value displayed. When all the vertical bars are fully illuminated and the last digit on the digital thickness value is stable, the **HPX** is reliably measuring the same value multiple times per second.
- B. **Battery Icon** – Indicates the remaining amount of battery life.
- C. **Velocity** – The current material velocity value setting. Displayed in English or Metric units, depending on current units setting.
- D. **Feature Status Bar** – Indicates the features currently enabled and in use, in the following order:
  - Measurement Mode (P-E, E-E, I-E, I-E-E)
  - Differential Mode (ON/OFF)
  - High Speed Scan Mode (ON/OFF)

- Alarm Mode (ON/OFF/AUDIBLE)
  - Gain Setting (Manual & Automatic (AGC))
- E. **Digital Material Thickness Value** – Smaller font size with hot menu visible, and larger font in full screen mode.
- F. **Scan Bar** – Another view of material thickness in a deflection style horizontal bar. Another visual tool offering the ability to see thickness changes during high speed scans.
- G. **Units** – The current measurement units (English, Metric).
- H. **Minimum Material Thickness** – Part of the scan feature. Displays the minimum thickness value found during a scan.
- I. **Maximum Material Thickness** – Part of the scan feature. Displays the maximum thickness value found during a scan.
- J. **B-Scan Display** – Cross section view of the material. Provides the user with graphical view of the opposite/blind surface.

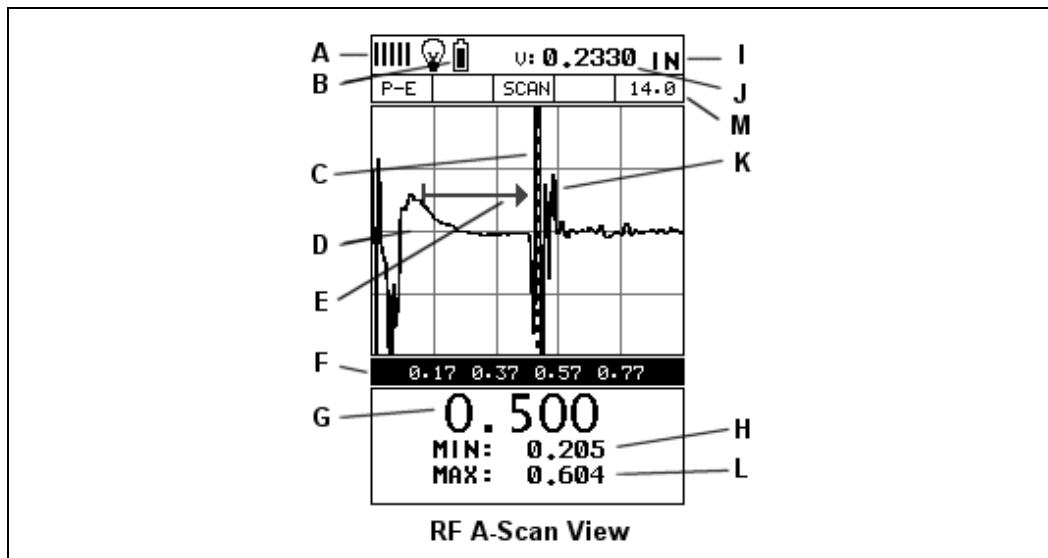

## Radio Frequency (RF) A-Scan

The RF mode shows the waveform in a similar fashion to an oscilloscope. It shows both the positive and the negative peaks – sine wave. In this view adjustments to the polarity, gates, gain, and threshold can be made in order to optimize the scope for an application.

In order for the wave to be viewable on the display, the measurement must be inside the boundaries of the delay and range. However, even if a detection is occurring outside of the display settings, or boundaries, a measurement can still be made. If the wave is outside of the display boundaries, it can be manually brought into view by adjusting the **Delay** and **Range**, or automatically adjusted into view using the **Auto Find** feature located in the UTIL menu. Refer to page 84 for additional information on the **Auto Find** feature.

The following is a list of the viewable features on the display:

- A. **Repeatability/Stability Indicator** – This indicator should be commonly used in conjunction with the digital thickness value displayed. When all the vertical bars are fully illuminated and the last digit on the digital thickness value is stable, the **HPX** is reliably measuring the same value multiple times per second.
- B. **Battery Icon** – Indicates the remaining amount of battery life.
- C. **Detect Indicator** – The broken vertical line displays the zero crossing, or flank detection point on the waveform where the measurement has been obtained.
- D. **Baseline** - The horizontal trace across the A-scan presentation for a no signal zero amplitude condition. It represents time, in terms of thickness/depth.
- E. **Gate** – An electronic feature that allows the user to monitor signals inside the boundaries of the gate settings. The height of the gate from the baseline is

known as the threshold, and controls the sensitivity of the reflections that trigger a detection from the opposite surface of the material.

- F. **Measurement Scale** – Represents thickness values over a defined measurement range, and is labeled at the calibrated hash marks on the display (X) axis.
- G. **Digital Material Thickness Value** – The thickness of the base material.
- H. **Minimum Thickness Value** – Dynamically updates the minimum value during a scan, and displays the minimum thickness value found. **Note:** *Only visible when high speed scan mode is enabled.*
- I. **Units** – The current measurement units (English, Metric).
- J. **Velocity** – The current material velocity value setting. Displayed in English or Metric units, depending on current units setting.
- K. **RF waveform** – The sine wave created by the reflected sound of the test material. The both the positive and negative half cycles (full cycles) are displayed.
- L. **Maximum Thickness Value** – Dynamically updates the maximum value during a scan, and displays the minimum thickness value found. **Note:** *Only visible when high speed scan mode is enabled.*
- M. **Feature Status Bar** - Indicates the features currently enabled and in use, in the following order:
  - Measurement Mode (P-E, E-E, E-EV)
  - Differential Mode (ON/OFF)
  - High Speed Scan Mode (ON/OFF)
  - Alarm Mode (ON/OFF/AUDIBLE)
  - Gain Setting (Manual & Automatic (AGC))

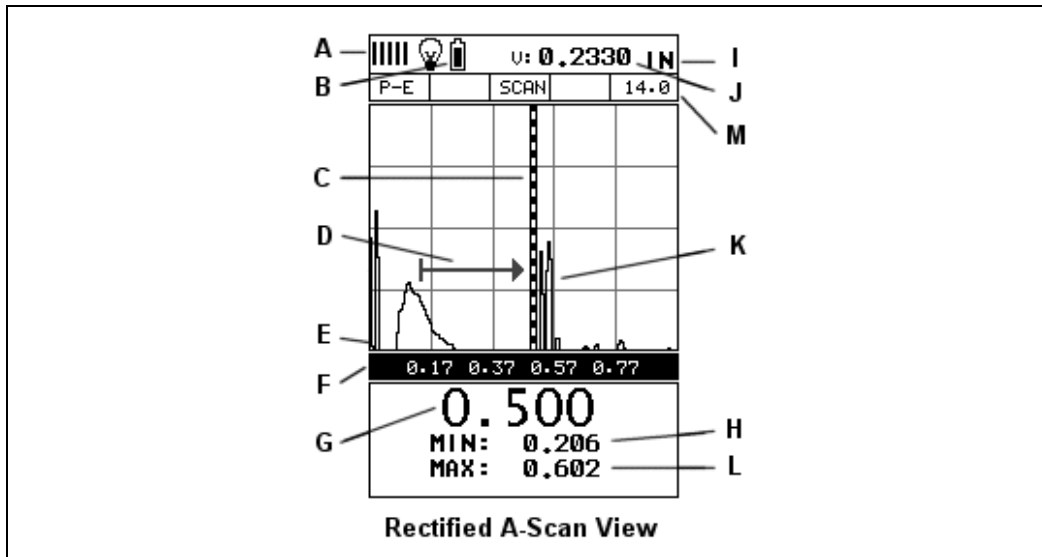

### Rectified (RECT) A-Scan

The RF mode shows the waveform in a similar fashion to an oscilloscope. It shows both the positive and the negative peaks. The peak (either positive or negative) selected for measurement is shown in upper portion of the display.

It's important to note that a measurement must fall inside the displays viewable range in order to see the waveform. However, even if the waveform is outside of the viewable range of the display, a measurement can be taken and viewed on the digital readout. If the wave is outside of the display range, you can manually change the range by adjusting the **Delay** and **Width** values, or you can use the **Auto Find** feature located in the **UTIL** menu of the tabbed menu items. Refer to page 84 for additional information on the **Auto Find** feature.

The following is a list of the viewable features on the display:

- A. **Repeatability/Stability Indicator** – This indicator should be commonly used in conjunction with the digital thickness value displayed. When all the vertical bars are fully illuminated and the last digit on the digital thickness value is stable, the **HPX** is reliably measuring the same value multiple times per second.
- B. **Battery Icon** – Indicates the remaining amount of battery life.
- C. **Detect Indicator** – The broken vertical line displays the zero crossing, or flank detection point on the waveform where the measurement has been obtained.
- D. **Gate** – An electronic feature that allows the user to monitor signals inside the boundaries of the gate settings. The height of the gate from the baseline is known as the threshold, and controls the sensitivity of the reflections that trigger a detection from the opposite surface of the material.
- E. **Baseline** - The horizontal trace across the A-scan presentation for a no signal zero amplitude condition. It represents time, in terms of thickness/depth.

- F. **Measurement Scale** – Represents thickness values over a defined measurement range, and is labeled at the calibrated hash marks on the display (X) axis.
- G. **Digital Material Thickness Value** – The thickness of the base material.
- H. **Minimum Thickness Value** – Dynamically updates the minimum value during a scan, and displays the minimum thickness value found. **Note:** *Only visible when high speed scan mode is enabled.*
- I. **Units** – The current measurement units (English, Metric).
- J. **Velocity** – The current material velocity value setting. Displayed in English or Metric units, depending on current units setting.
- K. **RECT waveform** – The half cycle, either positive or negative polarity, of the RF sine wave created by the reflected sound from the test material.
- L. **Maximum Thickness Value** – Dynamically updates the maximum value during a scan, and displays the minimum thickness value found. **Note:** *Only visible when high speed scan mode is enabled.*
- M. **Feature Status Bar** - Indicates the features currently enabled and in use, in the following order:
  - Measurement Mode (P-E, E-E, E-EV)
  - Differential Mode (ON/OFF)
  - High Speed Scan Mode (ON/OFF)
  - Alarm Mode (ON/OFF/AUDIBLE)
  - Gain Setting (Manual & Automatic (AGC))











## 6.2 Changing Display Options

The following procedure outlines how to select or toggle the display views:

### Changing Display View

| SET DISPLAY  |               |
|--------------|---------------|
| VIEW         | DIGITS        |
| DELAY        | 0.779         |
| RANGE        | 1.214         |
| B-SCAN SPEED | 6             |
| UNITS        | IN HR         |
| BACKLIGHT    | OFF           |
| CONTRAST     | 10            |
| RECT WAVE    | FILLED        |
| DETECT MARK  | DOTS          |
| PRB          | CAL DISP TUNE |

- 1) Press the  key once to activate the menu items tab. Press the  key multiple times to tab right, and the  key multiple times to tab left, until the **DISP** menu is highlighted and displaying the submenu items.
- 2) Use the  and  arrow keys to scroll through the sub menu items until **VIEW** is highlighted.
- 3) Use the  and  arrow keys to scroll the view options. Once the appropriate view is displayed, press the  key to return to the measurement screen and begin taking measurements.

## CHAPTER SEVEN

### ADJUSTING THE SCOPE

This chapter will focus on making adjustments to the A/B scan scope, using all the features available in the *HPX*.

#### 7.1 Delay & Range (B-Start/B-Depth)

The viewable range is set by adjusting the delay and range, with the delay controlling the start position of the left side of the display, and the range controlling the viewable area from the delay setting. Example, if the delay is set to '0', and the range is set to 1.0", the viewable area is 0 to 1.0". *Depending on the measure mode selected, the viewable range can be different from where the actual measurement occurs.* If the measure mode is set to pulse-echo (P-E) in the above example, the range would perfectly align with where the detection was measured on the display. However, if echo-echo (E-E) mode was used, the measurement detection would occur outside of the viewable range. To further explain why, pulse-echo measures from the initial pulse starting at zero, to a specific thickness or depth. While echo-echo measures between the first and second echo reflections. Depending on the length of the delay line, the actual measurement could be well outside of the display range settings.

While the delay and range are scaled in terms of in/mm, where the measurement occurs will vary with the measure mode selected. The delay can be swept left and right, and range zoomed in/out, in order to adjust the display to include the area where the measurement is being made.

**Note:** *If B-Scan mode is selected, B-Start and B-Depth will be used in place of Delay and Range, and operate identically.*

#### Setting the Delay (B-Start)









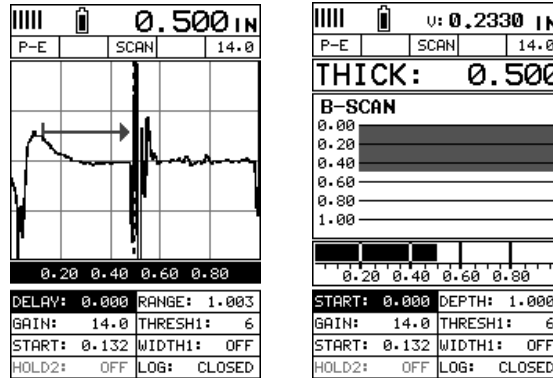





The Delay (B-Start) represents the start position of left side of the display, and is represented in terms of thickness/depth.

**Note:** *Delay and Range are stored independently of B-Start and B-Depth, and can be adjusted independent of one another.*

The procedure to adjust the **Delay (B-Start)** is outlined below:

**Adjusting Delay (B-Start) using the Hot Menu**







- 1) Press the  key once to activate hot menu items. Press the  key multiple times to move right and the  key multiple times to move left, until the **DELAY** cell is highlighted.
- 2) Press the     arrow keys to scroll the highlighted value.
- 3) **Alternatively**, press the  key to display the **Digits Edit Box**.
- 4) Press the  and  arrow keys to scroll the highlighted value.
- 5) Press the  and  arrow keys to scroll the digit locations.
- 6) Repeat steps **4 & 5** until the **DELAY** value is correctly displayed.
- 7) Press the  key to return to the measurement screen, or  to cancel entering the **DELAY**.
- 8) Finally, press the  key to return to the measurement screen and begin taking readings.

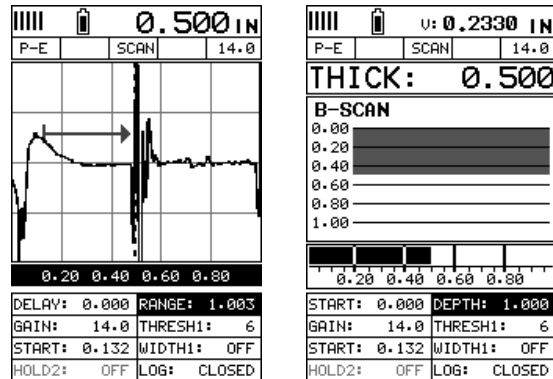

### Adjusting the Range (B-Depth)

The Range (B-Depth) + Delay (B-Start) equals the right side of the screen. Therefore, the Range (B-Depth) is the overall area, from the delay, that will be viewable on the screen. The procedures to adjust the overall thickness range viewed Range (B-Depth) are outlined below:







## Adjusting the Range (B-Depth) using the Hot Menu

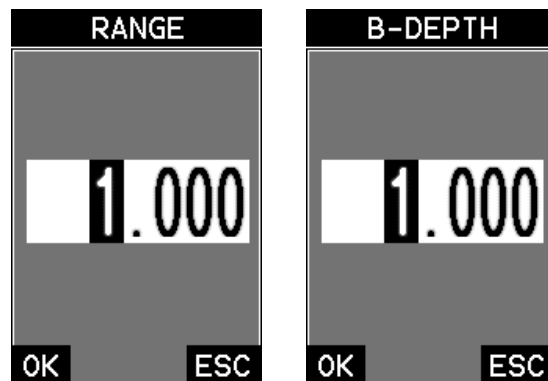

- 1) Press the  key once to activate measure menu items. Press the  key multiple times to move right and the  key multiple times to move left, until the **RANGE** cell is highlighted.

- 2) Press the     arrow keys to scroll the highlighted value.



- 3) **Alternatively**, press the  key to display the **Digits Edit Box**.
- 4) Press the  and  arrow keys to scroll the highlighted value.
- 5) Press the  and  arrow keys to scroll the digit locations.
- 6) Repeat steps 4 & 5 until the **RANGE** value is correctly displayed.
- 7) Press the  key to return to the measurement screen, or  to cancel entering the **RANGE**.









- 8) Finally, press the  key to return to the measurement screen and begin taking readings.







## Adjusting the B-Scan Speed

The **HPX** has the capability to adjust the scrolling speed of the time based B-Scan displayed in the gauge. The procedures to adjust the speed, only applicable if B-Scan view was selected, are outlined below:

### Adjusting the B-Scan Speed

| SET DISPLAY         |             |
|---------------------|-------------|
| VIEW                | BSCAN       |
| B-START             | 0.100       |
| B-DEPTH             | 1.000       |
| <b>B-SCAN SPEED</b> | <b>6</b>    |
| UNITS               | IN HR       |
| BACKLIGHT           | OFF         |
| CONTRAST            | 6           |
| RECT WAVE           | OUTLINE     |
| DETECT MARK         | DOTS        |
| <b>PRB</b>          | <b>CAL</b>  |
| <b>DISP</b>         | <b>TUNE</b> |

- 1) Press the  key once to activate the menu items tab. Press the  key multiple times to tab right, and the  key multiple times to tab left, until the **DISP** menu is highlighted and displaying the submenu items.
- 2) Use the  and  arrow keys to scroll through the sub menu items until **B-SCAN SPEED** is highlighted.
- 3) Use the  and  arrow keys to scroll the speed from 0-10. Note: 10 representing the fastest scroll time. Once the appropriate speed is displayed, press the  key to return to the measurement screen and begin the B-Scan process.
- 4) **Alternatively**, press the  key to display the **Digits Edit Box**.

- 5) Press the  and  arrow keys to scroll the highlighted value.
- 6) Press the  and  arrow keys to scroll the digit locations.
- 7) Repeat steps **5 & 6** until the **SPEED** is correctly displayed.
- 8) Press the  key to set the speed and return to the **DISP** menu., followed by pressing the  key to begin the B-Scan process.
- 9) Finally, press the  key to return to the measurement screen and begin the scanning process.

## 7.2 Gain – Manual & Auto (AGC)





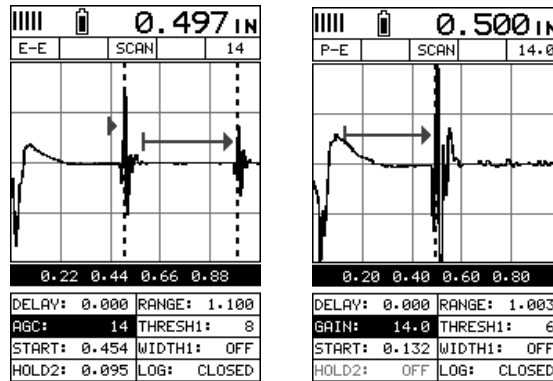

The gain, or amplification of the return echoes, can be adjusted in the **HPX** to accommodate a variety of applications. Gain is crucial in order to obtain valid readings during the measurement process. Too much gain may result in erroneous measurements, detecting on noise rather than the actual test materials back wall reflection. Not enough gain may result in intermittent detection, or no detection at all. The ability to vary the gain provides user the ability to ‘fine’ tune the gauge and transducer to the application. An example of gain might be similar to the volume on a stereo. If it’s turned up to high, you can’t hear the music clearly. If it’s down too low, you can’t hear it at all.

The **HPX** has 110dB gain range that can be controlled manually or automatically, depending on the measure mode selected. Additionally, the dynamic range of the automatic mode (AGC) can also be adjusted to optimize the **HPX** for a given application. Finally, adjustments to the gain can be made to optimize the visibility of the waves generated through the test material. Absorptive materials may require additional gain, while granular materials less gain due to noise.





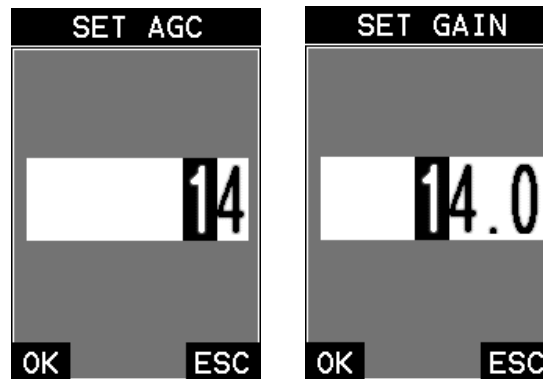

The procedures to adjust the **Gain** are outlined below:

### Adjusting the Gain using the Hot Menu



- 1) Press the  key once to activate measure menu items. Press the  key multiple times to move right, and the  key multiple times to move left until the **GAIN/AGC** cell is highlighted.
- 2) Press the     arrow keys to scroll the highlighted value.









- 3) **Alternatively**, press the  key to display the **Digits Edit Box**.
- 4) Press the  and  arrow keys to scroll the highlighted value.
- 5) Press the  and  arrow keys to scroll the digit locations.
- 6) Repeat steps 4 & 5 until the **GAIN/AGC** value is correctly displayed.
- 7) Press the  key to return to the measurement screen, or  to cancel entering the **GAIN/AGC**.





The gain can also be adjusted from the tabbed menus. However, this method is more tedious than making the adjustments using the **Hot Menu**. The procedure using the tabbed menus is outlined below:

### Adjusting the Gain using the Tabbed Menus

| TUNE SIGNAL       |          | TUNE SIGNAL       |          |
|-------------------|----------|-------------------|----------|
| MEASURE MODE      | E-E      | MEASURE MODE      | P-E      |
| POLARITY          | POSITIVE | POLARITY          | POSITIVE |
| PULSE             | THIN     | PULSE             | THIN     |
| PULSER VOLTAGE    | 150      | PULSER VOLTAGE    | 150      |
| DAMPING           | 300      | DAMPING           | 300      |
| GAIN              | 4.2      | GAIN              | 14.0     |
| AGC               | 14       | AGC               | 21       |
| AGC MAX           | 20.0     | AGC MAX           | 52.0     |
| TDC SLOPE         | 0.20     | TDC SLOPE         | 1.00     |
| TDC START         | AUTO     | TDC START         | 0.015    |
| PRB CAL DISP TUNE |          | PRB CAL DISP TUNE |          |

- 1) Press the  key once to activate the menu items tab. Press the  key multiple times to tab right, and the  key multiple times to tab left, until the **TUNE** menu is highlighted and displaying the submenu items.
- 2) Use the  and  arrow keys to scroll through the sub menu items until **GAIN/AGC** is highlighted.
- 3) Press the  and  arrow keys to scroll the value. When the correct **GAIN/AGC** is being displayed, **proceed to step 8.**



- 4) **Alternatively**, press the  key to display the **Digits Edit Box**.
- 5) Press the  and  arrow keys to scroll the highlighted value.
- 6) Press the  and  arrow keys to scroll the digit locations.



- 7) Repeat steps 5 & 6 until the **GAIN/AGC** value is correctly displayed.
- 8) Press the **OK** key to set the **GAIN/AGC** and return to the menu screen, or **ESC** to cancel entering the **GAIN/AGC**.
- 9) Finally, press the **MEAS** key to return to the measurement screen and begin taking readings.

### 7.3 Threshold

The **Threshold** is the level (sensitivity) of signal amplitude required to break the gate and detect. This level can be used in conjunction with the gain. Lowering the threshold level, or increasing the gain have similar effects. However, adjusting one over the other will often be the case during optimization of the scope. For example, if the material is producing a great deal of noise on the scope, lowering the threshold could be a better option over introducing additional gain, creating more noise.



The **HPX** is equipped with three independent gates, each with an adjustable threshold level. All three gates can be enabled only if a contact style transducer has been selected, and the mode is set to echo-echo-verify.





The procedures to adjust the **Thresholds** are outlined below:

**Adjusting the Thresholds using the Hot Menu**

|              |              |              |              |              |              |
|--------------|--------------|--------------|--------------|--------------|--------------|
| DELAY: -.024 | RANGE: 1.214 | DELAY: -.024 | RANGE: 1.214 | DELAY: -.024 | RANGE: 1.820 |
| GAIN: 1.0    | THRESH1: 6   | AGC: 14      | THRESH2: 5   | AGC: 14      | THRESH3: 2   |
| START: 0.057 | WIDTH1: OFF  | START: 0.461 | WIDTH2: OFF  | START: 0.461 | WIDTH2: OFF  |
| HOLD2: OFF   | LOG: A001    | HOLD2: 0.095 | LOG: A001    | HOLD3: 0.098 | LOG: A001    |



| THRESHOLDS  |    |
|-------------|----|
| THRESHOLD 1 | 10 |
| THRESHOLD 2 | 5  |
| THRESHOLD 3 | 2  |

1) Press the  key once to activate measure menu items. Press the  key multiple times to move right and the  key multiple times to move left, until the **THRESH(1-3)** cell is highlighted.





2) If the correct **THRESHOLD** is displayed, press the     arrow keys to scroll the highlighted value.

| THRESHOLDS |   |
|------------|---|
| THRESHOLD1 | 4 |
| THRESHOLD2 | 2 |
| THRESHOLD3 | 1 |

3) If the correct **Threshold** is not being displayed, press the  key to display the **List Box**.

4) Use the  and  arrow keys to scroll through the **List Box** items until the correct **THRESHOLD** is highlighted.

5) Press the  key to return to the measure screen and **Hot Menu** items.





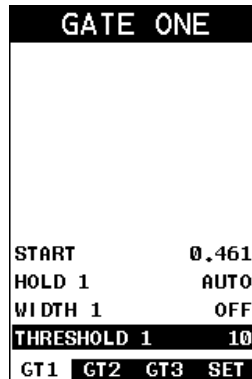

6) Press the     arrow keys to scroll the highlighted value.

7) Repeat steps 3-6 until all the **THRESH** values are correctly adjusted.





The threshold can also be adjusted from the tabbed menus. However, this method is more tedious than making the adjustments using **the Hot Menu**. The procedure for using the tabbed menu is outlined below:

### Adjusting the Thresholds using the Tabbed Menu

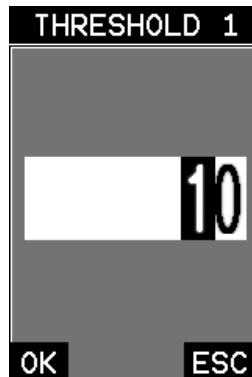

- 1) Press the  key once to activate the menu items tab. Press the  key multiple times to tab right, and the  key multiple times to tab left, until the **GT1** menu is highlighted and displaying the submenu items.
- 2) Use the  and  arrow keys to scroll through the sub menu items until **THRESHOLD1** is highlighted.
- 3) Press the  and  arrow keys to scroll the value. When the correct threshold is being displayed, **proceed to step 8.**



- 4) **Alternatively**, press the  key to display the **Digits Edit Box**.
- 5) Press the  and  arrow keys to scroll the highlighted value.
- 6) Press the  and  arrow keys to scroll the digit locations.
- 7) Repeat steps **5 & 6** until the **Threshold** number is correctly displayed.

- 8) Press the **OK** key to set the **Threshold** and return to the menu screen, or **ESC** to cancel entering the **Threshold**.
- 9) Repeat steps **1-8** to set any additional **Threshold** level.
- 10) Finally, press the **MEAS** key to return to the measurement screen and begin taking readings.

### 7.4 Understanding the features of the Gate

This section covers the operation and adjustment of the gates. The purpose of a gate is to set the boundaries of where a detection, or measurement, can occur. Each gate will have some combination of a start, width, hold-off (delay), and threshold level. These parameters provide the operator the ability to setup and tune the scope to measure in a specific area/region, while blocking unwanted reflections outside of the intended area. The following diagrams illustrate all the features of the gates based on the measure mode selected:

**Note:** This is a general overview and should be referred to in conjunction with the detailed feature sections that follow.

| Modes | # Gates  | Gate # | Start | HoldOff | Width | Threshold |
|-------|----------|--------|-------|---------|-------|-----------|
| P-E   | 1,2,or 3 | 1      | √     |         | √     | √         |
|       |          | 2      |       |         |       |           |
|       |          | 3      |       |         |       |           |
| E-E   | 2        | 1      | √     | √       | √     | √         |
|       |          | 2      |       | √       | √     | √         |
|       |          | 3      |       |         |       |           |
| E-EV  | 3        | 1      | √     | √       | √     | √         |
|       |          | 2      |       | √       | √     | √         |
|       |          | 3      |       | √       |       | √         |

Diag. 1 Gate Features vs Modes

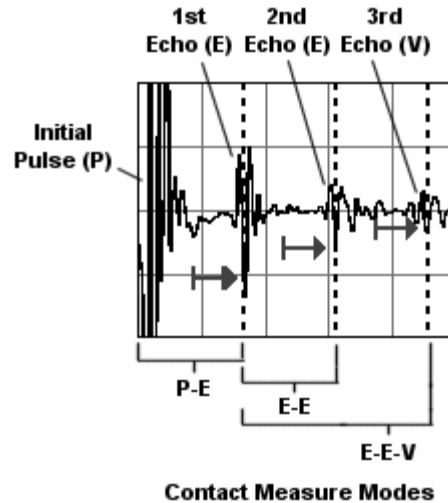

Diag. 2

In **diagram 1**, the gates have been associated with the measurement modes, along with the features available to every gate. For example, echo-echo mode (E-E) has 2 gates available, while echo-echo-verify (E-EV) has 3. These gates have been designed to work in order, from 1 to 3. Therefore, the user must be using gate 2 before they can activate and use gate 3. **Note:** *Gate 1 is on at all times, as a gate must be activated to measure.* Each gate has a given set of features to fine adjust the settings of the gate. The features are as follows:

**Start (Gate1):** This feature is only available to gate 1, and determines where gate 1 will start. Detection can only occur inside the boundaries of the gate. Therefore, if the measure mode is set to pulse echo (P-E), the start at 0.200", it's not possible to measure .100" without moving the gate to a value slightly less than 0.100". An initial pulse with a great deal of ring down, or a noisy material, can be avoided by moving the start further out in time/thickness. See diagram 2 above.

**Hold-Off:** The hold-off is the starting point of the left side of gates 2 & 3, and is used only if a detection is found inside the previous gate. It should be considered as a delay from the detection point of the previous gate. When the hold-off is off, or 0, the gate will start at the point of detection from the previous gate. As the value of the hold-off is increased, it is further delaying the start of the gate and increasing the minimum overall thickness range capability. A greater the hold off value loses the ability to measure thin materials. **Note:** *Although we've used the terminology of hold-off for gate 3, it is actually a "hold-back" from the detection of the second echo, and only available as a measure mode for 'contact transducers'. Therefore, as the value is increased, the "hold-back" moves closer to the second detection, just the opposite of the operation of gate 2 hold-off.* See diagram 2 above.

**Width:** The width determines the length of the gate. Therefore, the width – start (hold-ff) equals the length of the gate, as the start (hold-off) value is not equal to zero. If no detection is located inside the boundaries of a gate, the width value is used to start the next available gate. **Note:** *When the width is activated for a gate and assigned a value, the next available gate is also activated. Therefore, activating width1 of gate1 activates gate2, and activating width2 of gate2 activates gate3. See diagram 2.*

**Thresh:** The threshold controls the level of sensitivity of the signal amplitude required to trigger a detection, or measurement. It is represented by the distance from the baseline, and displayed as the vertical position of a gate. The further the vertical position is from the baseline, the less sensitive the threshold is, and vice versa. This offers additional control of the scope, to avoid unwanted detection on noise, or control over detections based on amplitude. This feature is used in conjunction with gain. Increasing the threshold has a similar effect of decreasing the gain, and vice versa. See diagram 2.

### **Activating the gates:**

- **Automatically:** *The gates are automatically activated, when a measurement mode is selected. Gate1 is active in all measurement modes. These modes have been internally setup at the Dakota factory. Selecting a transducer type, will automatically load a setup enabling the required gates for the mode selected. The factory setup should work fine as a general configuration, and has been optimized using 4340 mild steel calibration standards.*
- **Manually:** The gates can also be activated manually by using the Hot or Tabbed menus. For example, if a contact transducer was selected and pulse-echo is the measure mode, gate 2 can be activated by setting a value for gate 1 width, and gate 3 activated by setting a value for width 2.

## **7.5 Gates**

The **HPX** is equipped with up to three gates, depending on the measure mode selected. Gate 1 is active at all times in all measurement modes. These gates are full featured and completely adjustable. They can be fine tuned to accommodate a variety of applications. Diagram 1 in the previous section outlines the gates and features available for all measurement modes. Refer to the previous section for additional information.

**Note:** *In order to adjust the gates they must be activated. The gates are automatically activated depending upon the transducer type and measurement mode selected. If a gate is inactive, it will be grayed out in the hot and tabbed menus. The*

explanations that follow assume that the proper transducer type and measurement mode have been selected. Refer to page 27 for more information on selecting measurement modes.

These features are described in more detail below:

A common adjustment for Gate 1 would be adjusting the start position to avoid surface or transducer noise occurring immediately following the initial pulse.

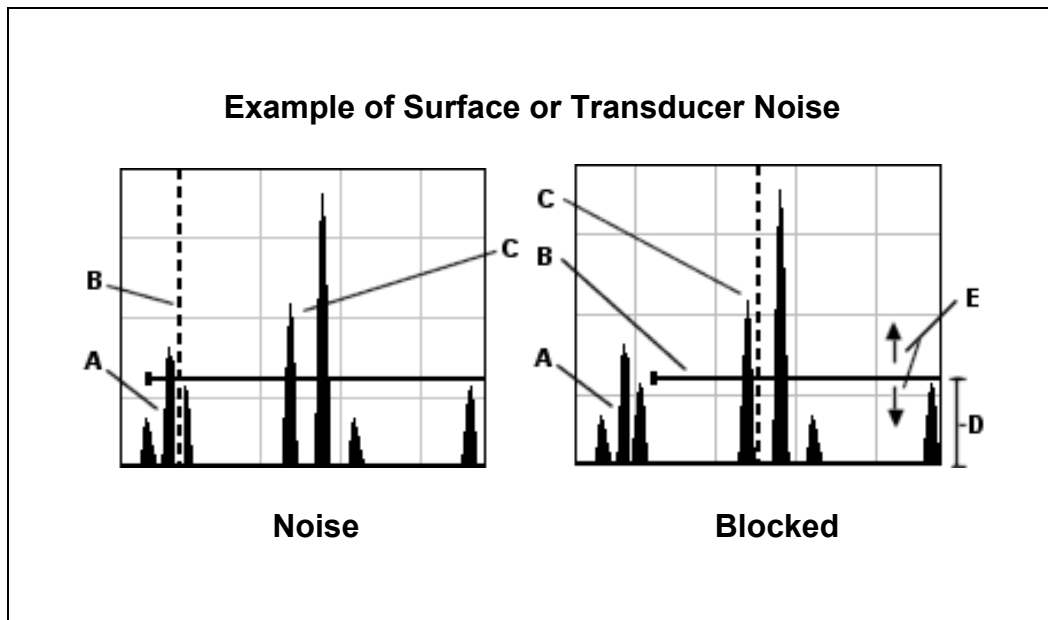

Refer to the **Noise** diagram: **(A)** refers to the noise in front of the actual back wall signal **(C)**. Notice the start position of the gate. As a result, the **HPX** is detecting on the noise **(A)** as shown at point **(B)**. However, the true measurement should be taken at point **(C)**. Given the start, threshold, and gain levels, the amplitude from the noise is sufficient enough to cause the **HPX** to detect, or measure the noise rather than the true back wall thickness **(C)**. Therefore, the **HPX** is making an incorrect measurement at point **(B)**.

Now refer to the **Blocked** diagram. The horizontal line at the top of **(D)**, is **GATE1**. The start of **GATE1** has been moved just beyond the noise **(A)** to block the noise and detect on the correct signal **(C)**. **Note: The HPX will only detect on signals that are located inside the dimensions of GATE1 (B)**. Therefore, the **HPX** is blocked from detection at point **(A)**, with the new starting point of the gate **(B)**. Also notice, the position of the threshold level with respect to the baseline **(D)**, which represents the sensitivity setting of the threshold. Extreme sensitivity is indicated by the bottom of the range **(D)** at the baseline, and less sensitivity indicated by the top of the range at **(D)**. Therefore, the vertical height of **GATE1** from the baseline is the threshold level. The threshold level can be increased to decrease sensitivity, or vice versa.

If the threshold level was increased in the **Noise** diagram, so that the vertical position of **GATE1** was higher than the amplitude of the noise (**A**), the **HPX** would have detected on the true back wall (**C**). Alternatively, if the gain level was decreased, the signal amplitude of the noise (**A**) would have decreased below the threshold level, and the **HPX** would have also detected the true back wall (**C**). This example brings all the fine adjustments into consideration, and demonstrates the versatility of having a fully functional scope rather than a basic digital thickness gauge.

The procedures to adjust all of the features associated with the **Gates** are outlined below:

**Note:** This is a combined procedure that works the same for any of the features associated with the gates. **ALL = Start, Hold, Width and Threshold.**

### Gate Adjustments - Hot Menu

|                     |               |                     |              |              |                      |
|---------------------|---------------|---------------------|--------------|--------------|----------------------|
| DELAY: 0.300        | RANGE: 1.000  | DELAY: 0.300        | RANGE: 1.000 | DELAY: 0.300 | RANGE: 1.000         |
| AGC: 0              | THRESH3: 1    | AGC: 0              | THRESH2: 2   | AGC: 0       | THRESH3: 1           |
| <b>GATE1: 0.040</b> | WIDTH3: 0.040 | GATE1: 0.040        | WIDTH2: OFF  | GATE1: 0.040 | <b>WIDTH3: 0.040</b> |
| HOLD3: 0.050        | LOG: CLOSED   | <b>HOLD2: 0.050</b> | LOG: CLOSED  | HOLD3: 0.050 | LOG: CLOSED          |









**Start**
**Hold**
**Width**

- 1) Press the key once to activate measure menu items. Press the key multiple times to move right and the key multiple times to move left, until the **ALL** cell is highlighted.
- 2) If the correct **ALL** is displayed, press the arrow keys to scroll the highlighted value.

HOLDOFFS

|           |       |
|-----------|-------|
| HOLDOFF 2 | 0.050 |
| HOLDOFF 3 | 0.050 |







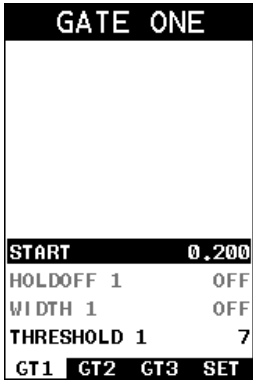

- 3) **Alternatively**, if the correct **ALL** is not being displayed, press the  key to display the **List Box**.
- 4) Use the  and  arrow keys to scroll through the **List Box** items until the correct **ALL** is highlighted.
- 5) Press the  key to return to the measure screen and **Hot Menu** items.
- 6) Press the     arrow keys to scroll the highlighted value.
- 7) Repeat steps **3-6** until all the **ALL** values are correctly adjusted.

These features can also be adjusted from the tabbed menus. However, this method is more tedious than making the adjustments using **the Hot Menu**. The procedure is outlined below:







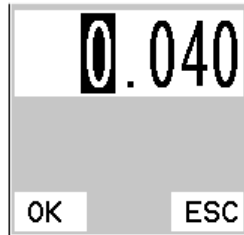

**Gate Adjustments - Tab Menu**



- 1) Press the  key once to activate the menu items tab. Press the  key multiple times to tab right, and the  key multiple times to tab left, until the **ALL** menu is highlighted and displaying the submenu items.
- 2) Use the  and  arrow keys to scroll through the sub menu items until **ALL** is highlighted.

- 3) Press the  and  arrow keys to scroll the value. When the correct **ALL** is being displayed, **proceed to step 8.**



- 4) **Alternatively**, press the  key to display the **Digits Edit Box**.
- 5) Press the  and  arrow keys to scroll the highlighted value.
- 6) Press the  and  arrow keys to scroll the digit locations.
- 7) Repeat steps **5 & 6** until the **ALL** number is correctly displayed.
- 8) Press the  key to set the **ALL** and return to the menu screen, or  to cancel entering the **ALL**.
- 9) Repeat steps **1-8** to set any additional **ALL** level.
- 10) Finally, press the  key to return to the measurement screen and begin taking readings.

## CHAPTER EIGHT THRU PAINT MEASUREMENT TECHNIQUE

### 8.1 Introduction to Thru Paint Measurement

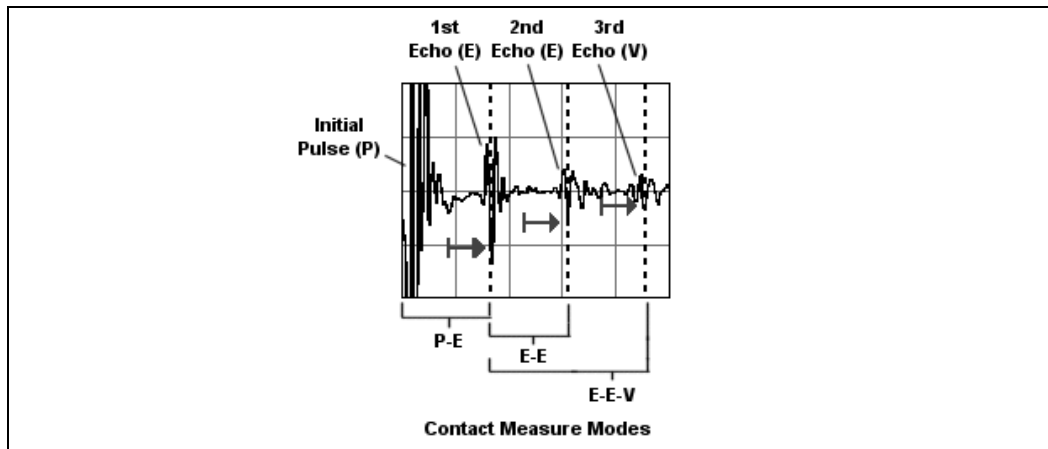

In order to measure through paint and eliminate the error from the paint or coating, a measurement is made using two backwall reflections/echoes. Since both of these back wall echoes travel the same path through the paint or coating, the thickness of the coating is eliminated from the measurement and base material measured. It can certainly prove to be an advantageous feature, avoiding the time to scrape and removing the coating from the test material prior to measuring.

With all of the measurement mode and multiple transducer options in the **HPX**, the primary through paint mode options are echo-echo (E-E) and echo-echo-verify (E-EV) using a contact style transducer. The echo-echo-verify option is a triple echo mode that compares the measurement made between the 1<sup>st</sup> and 2<sup>nd</sup> echoes, against the measurement between the 2<sup>nd</sup> and 3<sup>rd</sup> echoes. By doing this, the **HPX** can confirm that a peak jump hasn't occurred and the measurement made is stable and correct. This mode is only suitable for thin materials and coatings, as the ability to achieve 3 reflections from the test material isn't always possible.

### 8.2 Using Thru Paint Mode

Selecting the transducer type, will automatically load the measurement modes available to the transducer. The modes have been preconfigured using 4340 mild steel calibration standards. Depending on the type and thickness of the

paint/coating, adjustments may be necessary to optimize the setup. Once the settings have been optimized, the setup can be saved and recalled at any time.

**Note:** *Once a transducer type has been selected, all the measurement modes available to the transducer can be recalled by pressing the multi-mode key.*

When configuring the **HPX** for specific thru paint applications, all the parameters associated with the scope may require adjustment/tuning. As a result, the delay, range, gain (AGC), thresholds, gates, and hold-offs have been added to the hot menu for quick and easy access.

**Note:** *Once the values of the fields have been changed or modified, these changes must be saved to a setup location prior to powering the **HPX** off. **Failure to do so will result in losing your changes.** Refer to page 118 for additional information on setups.*

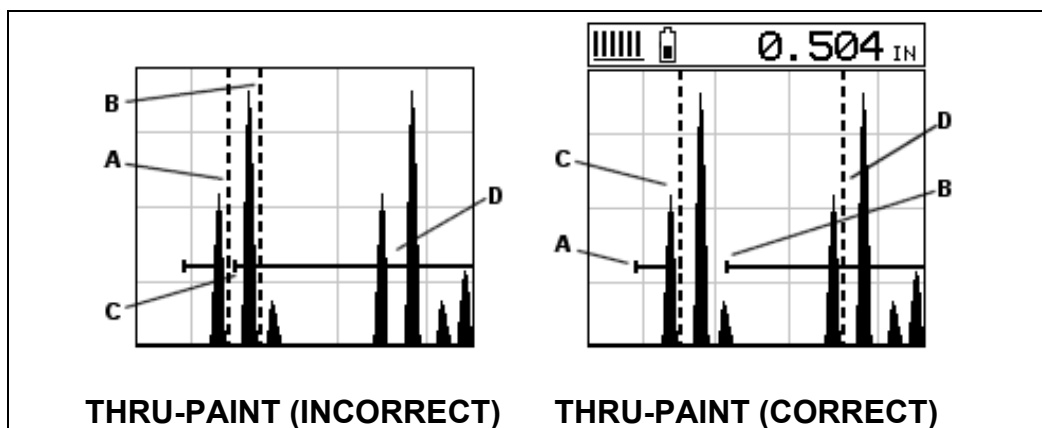

Refer to the incorrect diagram above. Point **(A)** represents the detection on the first back wall echo. The true, second back wall, reflection should be detecting at point **(D)**. However, the hold-off **(C)** is setup incorrectly and the **HPX** is detecting the ring down noise of the transducer, on the first reflection, rather than the true second back wall reflection shown at **(D)**.

Before we look at the diagram with the correct configuration, let's consider all of our options on how to fix the problem beforehand. Our **delay** and **Range** will simply change the view options of the screen – not needed in this example. Will a **gain(AGC)** or **threshold** adjustment fix the problem? Unfortunately, not. Why? Notice the amplitude of the cycle just to the left of **(B)**. If we tried to increase the threshold level above the height of the cycle, we would lose our detection for both echoes resulting in no reading at all. If we decrease our **gain(AGC)**, reducing the signal amplitudes, we would also lose our detection of both back wall echoes.

Notice that the amplitude of the cycle just to the left of **(C)**. The amplitude of the cycle, at **(C)**, is less than the amplitude of the cycle at **(B)**, in terms of overall height. If we decreased our **gain(AGC)**, we would lose the first cycle **(C)** long before losing the second cycle **(B)**. Therefore, adjusting the **gain(AGC)** or **threshold** levels will not help us in this example. Our final option is adjusting the **GATE2** hold-off, shown at point **(C)** in the incorrect diagram, to point **(B)** in the correct diagram. If we adjust the **GATE2** hold-off further to the right of the first reflection, the ring down noise from the first back wall echo no longer interferes with the true detection **(D)**, shown in the correct diagram.

The adjustment considerations in the example above will typically be used for all thru paint applications respectively. In some applications the hold-off may be sufficient, while a **gain(AGC)** or **thresholds** adjustment will solve the problem. A similar process of elimination should be considered for all thru paint applications.

## CHAPTER NINE ADDITIONAL FEATURES OF THE HPX









### 9.1 Units

The **HPX** measures in both English and Metric units. Both have a high and low resolution option; IN, IN HR, MM, MM HR. Standard resolution is 0.01in (0.1mm), and HR resolution is 0.001" (0.01mm), or standard resolution at 0.01" (0.1mm).

The procedure for toggling the units is outlined below:

**Unit Options**

| SET DISPLAY  |        |
|--------------|--------|
| VIEW         | RF     |
| DELAY        | 1.169  |
| RANGE        | 0.076  |
| B-SCAN SPEED | 6      |
| UNITS        | IN HR  |
| BACKLIGHT    | OFF    |
| CONTRAST     | 10     |
| RECT WAVE    | FILLED |
| DETECT MARK  | DOTS   |
| PRB          | CAL    |
| DISP         | TUNE   |

- 1) Press the  key once to activate the menu items tab. Press the  key multiple times to tab right and the  key multiple times to tab left until the **DISP** menu is highlighted and displaying the submenu items.
- 2) Use the  and  arrow keys to scroll through the sub menu items until **UNITS** is highlighted.
- 3) Press the  and  arrow keys to toggle the options; IN, IN HR, MM, MM HR.
- 4) Finally, press the  key to return to the measurement screen and begin taking readings.









## 9.2 Backlight

The **HPX** LCD display is equipped with a backlight to adjust for various light conditions. There's an 'auto' option that will only illuminate the display when coupled. Additionally, there's a screen 'invert' for extreme sunlight conditions.

The procedure for enabling and adjusting the backlight is outlined below:

**Backlight Options**

| SET DISPLAY       |         |
|-------------------|---------|
| VIEW              | RF      |
| DELAY             | -.024   |
| RANGE             | 1.214   |
| B-SCAN SPEED      | 6       |
| UNITS             | IN HR   |
| BACKLIGHT         | OFF     |
| CONTRAST          | 10      |
| RECT WAVE         | OUTLINE |
| DETECT MARK       | DOTS    |
| PRB CAL DISP TUNE |         |

- 5) Press the  key once to activate the menu items tab. Press the  key multiple times to tab right and the  key multiple times to tab left until the **DISP** menu is highlighted and displaying the submenu items.
- 6) Use the  and  arrow keys to scroll through the sub menu items until **BACKLIGHT** is highlighted.
- 7) Press the  and  arrow keys to scroll the options; on, off, auto, invert.
- 8) Finally, press the  key to return to the measurement screen and begin taking readings.









## 9.3 Contrast

The **HPX** LCD display has a contrast feature to control the display light/dark appearance. This used to optimize the display for various light conditions, and has an arbitrary scale of 1-20, with 20 representing the brightest setting.

The procedure for changing the contrast is outlined below:

### Setting Contrast

| SET DISPLAY     |               |
|-----------------|---------------|
| VIEW            | RF            |
| DELAY           | -.024         |
| RANGE           | 1.214         |
| B-SCAN SPEED    | 6             |
| UNITS           | IN HR         |
| BACKLIGHT       | OFF           |
| <b>CONTRAST</b> | <b>10</b>     |
| RECT WAVE       | OUTLINE       |
| DETECT MARK     | DOTS          |
| PRB             | CAL DISP TUNE |

- 1) Press the  key once to activate the menu items tab. Press the  key multiple times to tab right and the  key multiple times to tab left until the **DISP** menu is highlighted and displaying the submenu items.
- 2) Use the  and  arrow keys to scroll through the sub menu items until **CONTRAST** is highlighted.
- 3) Press the  and  arrow keys to scroll the contrast value.
- 4) Finally, press the  key to return to the measurement screen and begin taking readings.

## 9.4 Rectified Wave Options

When the display is set to rectified view, there are two graphics options available for the waveform; outline and filled. The outline option simply outlines the wave, and the filled option paints everything under the wave outline.

The procedure for changing the graphic option is outlined below:

### Wave Options



1) Press the key once to activate the menu items tab. Press the key multiple times to tab right and the key multiple times to tab left until the **DISP** menu is highlighted and displaying the submenu items.

2) Use the and arrow keys to scroll through the sub menu items until **RECT WAVE** is highlighted.

3) Press the and arrow keys to scroll the options.

4) Finally, press the key to return to the measurement screen and begin taking readings.

### 9.5 Detect Mark

Another graphics option available in the *HPX* is the detection mark. There are three options; dots, line, none. When enabled, displays a vertical line or dots where the detection point occurs on the wave.

The procedure for selecting the detection mark is outlined below:

### Wave Options

1) Press the **MENU** key once to activate the menu items tab. Press the **MENU** key multiple times to tab right and the **ESC** key multiple times to tab left until the **DISP** menu is highlighted and displaying the submenu items.

2) Use the **▲** and **▼** arrow keys to scroll through the sub menu items until **DETECT MARK** is highlighted.

3) Press the **◀** and **▶** arrow keys to scroll the options.

4) Finally, press the **MEAS** key to return to the measurement screen and begin taking readings.

## 9.6 Polarity

The **HPX** is equipped with an option to select the polarity, or phase +/-, for the purpose of detection. The phase can be a valuable feature when the signal returning from the test material is marginal because of a weak first positive or negative cycle. The ability to review the waveform and select the optimal polarity offers additional flexibility during setup. Refer to the diagram below:

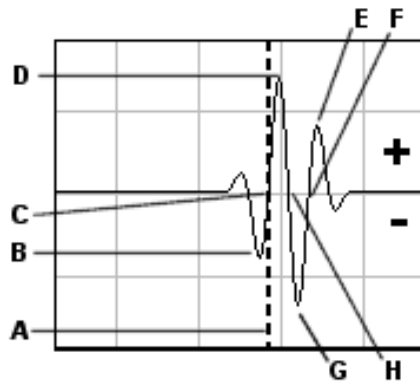









Notice the +/- positions in the diagram. The positive phase is everything above the horizontal center line, and the negative everything below the center line. In this example the **HPX** is using a zero crossing method for detection. Therefore, the detect line (**A**) is represented by the broken vertical dotted line, and is currently detecting on the negative portion of the waveform (**B**) at the zero crossing (**C**). The signal amplitude (**B**) is shown as the negative vertical height at (**B**) in the diagram. Refer to the height of the second negative peak at (**G**). It's clear that the amplitude of (**G**) is much greater than that of (**B**). Therefore, if the user was measuring thick absorptive material, and the amplitude of (**B**) decreased substantially, the **HPX** would lose the first cycle (**B**) and peak jump to the second cycle (**F**). The detect (**A**), would move to (**F**), resulting in incorrect measurements.

If the user were to select the positive phase in the diagram above, the detect would measure at (**H**). (**A**) would move to (**H**). Notice the height of (**D**) with respect to the height of (**E**) in the diagram. If the user was measuring thick absorptive material using this phase, the signal (**E**) will certainly be lost long before (**D**). Therefore, the positive phase is a much better choice in the diagram above.

The procedure for selecting the polarity is outlined below:

| <b>Polarity/Phase</b> |                 |
|-----------------------|-----------------|
| <b>TUNE SIGNAL</b>    |                 |
| MEASURE MODE          | P-E             |
| <b>POLARITY</b>       | <b>NEGATIVE</b> |
| PULSE                 | THIN            |
| PULSER VOLTAGE        | 150             |
| DAMPING               | 300             |
| GAIN                  | 1.0             |
| AGC                   | 21              |
| AGC MAX               | 52.0            |
| TDC SLOPE             | 1.00            |
| TDC START             | 0.015           |
| PRB                   | CAL DISP TUNE   |









- 1) Press the  key once to activate the menu items tab. Press the  key multiple times to tab right and the  key multiple times to tab left until the **TUNE** menu is highlighted and displaying the submenu items.
- 2) Use the  and  arrow keys to scroll through the sub menu items until **POLARITY** is highlighted.
- 3) Press the  and  arrow keys to scroll the options.
- 4) Finally, press the  key to return to the measurement screen and begin taking readings.

## 9.7 Pulse Width

The **HPX** has an adjustable pulse width option. Pulse width, refers to the duration of time the pulser is left on. This time results in increased energy sent into the test material. There are three width options for the 200 volt pulser (**SPIKE**, **THIN**, and **WIDE**), three width options for the high voltage 400 volt pulser (**HV SPK**, **HV THIN**, and **HV WIDE**). The **SPIKE** setting may be desirable for higher resolution and general applications to decrease the overall noise, while the **THIN** and **WIDE** settings for additional penetration requirements. The procedure to change the pulse width is outlined below:

**Selecting the Pulse Width**

| TUNE SIGNAL       |             |
|-------------------|-------------|
| MEASURE MODE      | P-E         |
| POLARITY          | POSITIVE    |
| <b>PULSE</b>      | <b>THIN</b> |
| PULSER VOLTAGE    | 150         |
| DAMPING           | 300         |
| GAIN              | 1.0         |
| AGC               | 21          |
| AGC MAX           | 52.0        |
| TDC SLOPE         | 1.00        |
| TDC START         | 0.015       |
| PRB CAL DISP TUNE |             |

- 1) Press the  key once to activate the menu items tab. Press the  key multiple times to tab right and the  key multiple times to tab left until the **TUNE** menu is highlighted and displaying the submenu items.
- 2) Use the  and  arrow keys to scroll through the sub menu items until **PULSE** is highlighted.
- 3) Use the  and  arrow keys to scroll the **PULSE** options.
- 4) Once the desired option is displayed, press the  key to return to the measurement screen.









## 9.8 Pulser Voltage

The **HPX** has an adjustable 200 volt spike pulser (100, 150, 200 volts), an adjustable high voltage 400 volt square wave pulser (200, 300, 400 volts), and an 400 volt tone burst pulser with tuned bursts at frequencies of (500 kHz, 1 MHz, 2 MHz, 5 MHz & 10 MHz), and (200, 300, 400 volt) options. The variety of pulser options and settings included in the HPX offers a great deal of diversity for materials requiring additional penetration, as well as an assortment of transducer types and frequencies options to address materials that are difficult to penetrate such as; fiberglass, fiber reinforced plastic, composites, carbon fiber, and rubber applications.

The procedure to change the pulser voltage is outlined below:

### Changing the Pulser Voltage

| TUNE SIGNAL           |            |
|-----------------------|------------|
| MEASURE MODE          | P-E        |
| POLARITY              | NEGATIVE   |
| PULSE                 | HV THIN    |
| <b>PULSER VOLTAGE</b> | <b>300</b> |
| DAMPING               | 300        |
| GAIN                  | 1.0        |
| AGC                   | 21         |
| AGC MAX               | 52.0       |
| TDC SLOPE             | 1.00       |
| TDC START             | 0.015      |
| PRB CAL DISP          | TUNE       |

- 1) Press the  key once to activate the menu items tab. Press the  key multiple times to tab right and the  key multiple times to tab left until the **TUNE** menu is highlighted and displaying the submenu items.
- 2) Use the  and  arrow keys to scroll through the sub menu items until **PULSER VOLTAGE** is highlighted.
- 3) Use the  and  arrow keys to scroll the voltage options.
- 4) Once the desired voltage is displayed, press the  key to return to the measurement screen and begin taking readings.









## 9.9 Damping

The **HPX** has a built-in damping feature to control the impedance input of the receiver. This enables the user the ability to match and optimize the transducer for better signal quality at various frequencies. The available settings are 50, 75, 100, 300, 600 and 1500 ohms.

The procedure below outlines the steps for selecting an impedance setting as follows:

**Setting the Damping Value**

| TUNE SIGNAL    |            |
|----------------|------------|
| MEASURE MODE   | E-E        |
| POLARITY       | NEGATIVE   |
| PULSE          | THIN       |
| PULSER VOLTAGE | 150        |
| <b>DAMPING</b> | <b>300</b> |
| GAIN           | 4.8        |
| AGC            | 14         |
| AGC MAX        | 20.0       |
| TDC SLOPE      | 1.00       |
| TDC START      | AUTO       |
| PRB CAL DISP   | TUNE       |



- 1) Press the  key once to activate the menu items tab. Press the  key multiple times to tab right, and the  key multiple times to tab left, until the **TUNE** menu is highlighted and displaying the submenu items.
- 2) Use the  and  arrow keys to scroll through the sub menu items until **DAMPING** is highlighted.
- 3) Use the  and  arrow keys to scroll through the **DAMPING** values until the correct value is displayed.
- 4) Finally, press the  key to return to the measurement screen and begin taking readings.





## 9.10 AGC MAX

The automatic gain control max feature adds additional versatility when using contact style transducers in echo-echo (E-E) and echo-echo verify (E-EV) modes, to control the maximum allowable gain. Depending on the transducer diameter and frequency, the ability to control the max gain allows for fine tuning the transducers performance.

### Setting AGC Max

| TUNE SIGNAL    |               |
|----------------|---------------|
| MEASURE MODE   | E-E           |
| POLARITY       | POSITIVE      |
| PULSE          | THIN          |
| PULSER VOLTAGE | 150           |
| DAMPING        | 300           |
| GAIN           | 20.0          |
| AGC            | 14            |
| <b>AGC MAX</b> | <b>20.0</b>   |
| TDG SLOPE      | 0.20          |
| TDG START      | AUTO          |
| PRB            | CAL DISP TUNE |

- 5) Press the  key once to activate the menu items tab. Press the  key multiple times to tab right, and the  key multiple times to tab left, until the **TUNE** menu is highlighted and displaying the submenu items.

- 6) Use the  and  arrow keys to scroll through the sub menu items until **AGC MAX** is highlighted.
- 7) Use the  and  arrow keys to scroll **AGC MAX** until the correct value is displayed.
- 8) Finally, press the  key to return to the measurement screen and begin taking readings.

## 9.11 Gain Slope (TDG)

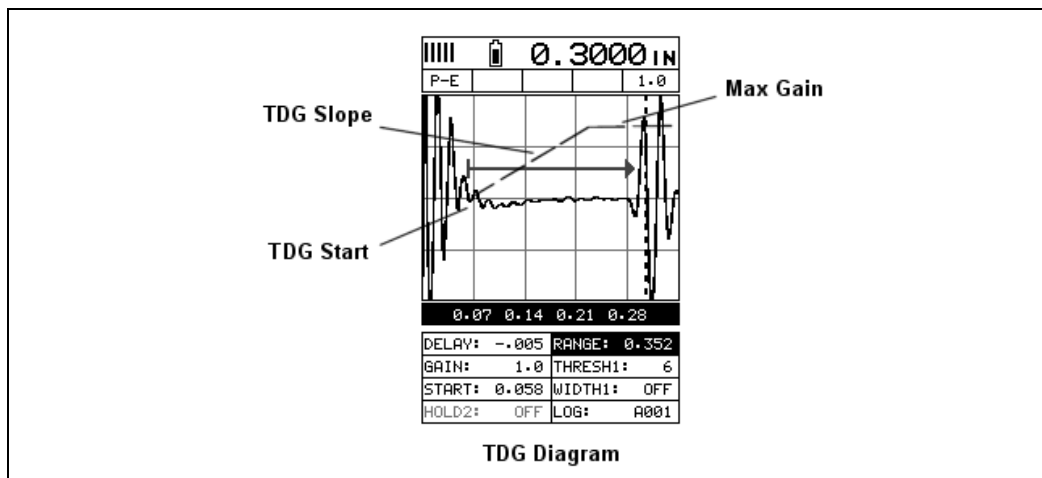









The **HPX** has a gain slope feature that is similar to a basic linear time corrected gain function, or “time dependent gain” **TDG**. The slope can be adjusted from 0-40 decibels per inch depth. It can be used in all measurement modes (P-E, E-E, E-EV), and automatically tracks and starts just following first echo in multiple echo modes (E-E, E-EV). However, in pulse-echo (P-E) mode the start can be manually adjusted to start the slope where needed. Refer to section on **TDG START** for additional information. A useful feature for improving sensitivity and overall output with respect to thickness/depth.

The procedure below outlines the steps to enable and set the gain slope, as follows:



### Setting the Gain Slope

| TUNE SIGNAL      |               |
|------------------|---------------|
| MEASURE MODE     | P-E           |
| POLARITY         | NEGATIVE      |
| PULSE            | HV THIN       |
| PULSER VOLTAGE   | 300           |
| DAMPING          | 300           |
| GAIN             | 1.0           |
| AGC              | 21            |
| AGC MAX          | 52.0          |
| <b>TDG SLOPE</b> | <b>1.00</b>   |
| TDG START        | 0.015         |
| PRB              | CAL DISP TUNE |

- 1) Press the  key once to activate the menu items tab. Press the  key multiple times to tab right, and the  key multiple times to tab left, until the **TUNE** menu is highlighted and displaying the submenu items.
- 2) Use the  and  arrow keys to scroll through the sub menu items until **GAIN SLOPE** is highlighted.
- 3) Use the  and  arrow keys to scroll the **GAIN SLOPE** value until the correct value is displayed to the right of the **GAIN SLOPE** menu item.
- 4) Finally, press the  key to return to the measurement screen and begin taking readings.









### 9.12 TDG Start

This feature only applies to the pulse-echo measure mode, as the start for multi-echo modes (E-E, E-EV) automatically start just following the first return echo. The start of the TDG slope begins at the initial gain setting of the gauge, and increases at the rate of the slope setting until “max gain” has been reached.

The procedure below outlines the steps to enable and set the gain start, as follows:

### Setting the Gain Start

| TUNE SIGNAL    |          |
|----------------|----------|
| MEASURE MODE   | P-E      |
| POLARITY       | NEGATIVE |
| PULSE          | HV THIN  |
| PULSER VOLTAGE | 300      |
| DAMPING        | 300      |
| GAIN           | 1.0      |
| AGC            | 21       |
| AGC MAX        | 52.0     |
| TDG SLOPE      | 1.00     |
| TDG START      | 0.015    |
| PRB            | CAL      |
| DISP           | TUNE     |

- 1) Press the  key once to activate the menu items tab. Press the  key multiple times to tab right, and the  key multiple times to tab left, until the **TUNE** menu is highlighted and displaying the submenu items.
- 2) Use the  and  arrow keys to scroll through the sub menu items until **GAIN START** is highlighted.
- 3) Use the  and  arrow keys to scroll the **GAIN START** value until the correct value is displayed to the right of the **GAIN START** menu item.
- 4) Finally, press the  key to return to the measurement screen and begin taking readings.

### 9.13 Auto Find







The **HPX** is equipped with a very handy feature for locating the detection point of a back wall echo that is not currently in the viewable region of the display. Suppose the **HPX** is currently setup with a delay of 0.000" and a range of 0.500", but the target thickness measured is at 1.000". Using the auto find will automatically adjust and setup the delay and range, bringing the waveform into view on the display.

The procedure to use the **AUTO FIND** feature is outlined below:

#### Using Auto Find

| UTILITIES        |        |
|------------------|--------|
| <b>AUTO FIND</b> |        |
| SCAN MODE        | OFF    |
| ALARM            | OFF    |
| ALARM HIGH       | 1.000  |
| ALARM LOW        | 0.000  |
| DIFFERENTIAL     | OFF    |
| KEY CLICK        | QUIET  |
| SET DATE         | MMDDYY |
| SHOW DATE        | OFF    |
| DATA UTIL XFER   |        |

**Note:** The transducer must be coupled to test material and measuring prior to using this function.

- 1) Press the  key once to activate the menu items tab. Press the  key multiple times to tab right, and the  key multiple times to tab left, until the **UTIL** menu is highlighted and displaying the submenu items.
- 2) Use the  and  arrow keys to scroll through the sub menu items until **AUTO FIND** is highlighted.
- 3) Press the  key to display the confirmation screen.
- 4) Press the  key to automatically adjust the delay and range, and being taking readings.









## 9.14 High Speed Scan

The High Speed Scan feature of the **HPX** increases the overall repetition/sample rate to 140Hz with a screen refresh rate of 25 times a second (25Hz). This feature enables a user to make scanned passes over an arbitrary length of the test material, while still maintaining a reasonable representation of thickness over the scanned area or region. This feature can be used in conjunction with High and Low alarm limits features to dynamically keep track of both values. The feature is typically used to provide a better representation of the area scanned, by taking more readings at a faster rate.

The procedure to use the **SCAN MODE** is outlined below:

### Using the Scan Mode

| UTILITIES             |           |
|-----------------------|-----------|
| AUTO FIND             |           |
| <b>SCAN MODE</b>      | <b>ON</b> |
| ALARM                 | ON        |
| ALARM HIGH            | 1.000     |
| ALARM LOW             | 0.000     |
| DIFFERENTIAL          | OFF       |
| KEY CLICK             | QUIET     |
| SET DATE              | MMDDYY    |
| SHOW DATE             | OFF       |
| <b>DATA UTIL XFER</b> |           |

- 1) Press the  key once to activate the menu items tab. Press the  key multiple times to tab right and the  key multiple times to tab left until the **UTIL** menu is highlighted and displaying the submenu items.
- 2) Use the  and  arrow keys to scroll through the submenu items until **SCAN MODE** is highlighted.
- 3) Use the  and  arrow keys to toggle the **SCAN MODE** on/off.
- 4) Press the  key to return to the measurement screen.







## 9.15 Alarm Mode

The **Alarm Mode** feature of the *HPX* provides a method of setting tolerances, or limits, for a given application. This feature may be used for a variety of applications to verify the material is in allowable tolerance. There is a high & low limit option that can be used together or individually. There are alarm LED's, as well as an audible beeper that can be enabled.

The procedures to use the **ALARM MODE** feature are outlined below:

### Activating Alarm (on/off)



| UTILITIES      |           |
|----------------|-----------|
| AUTO FIND      |           |
| SCAN MODE      | ON        |
| <b>ALARM</b>   | <b>ON</b> |
| ALARM HIGH     | 0.225     |
| ALARM LOW      | 0.190     |
| DIFFERENTIAL   | OFF       |
| KEY CLICK      | QUIET     |
| SET DATE       | MMDDYY    |
| SHOW DATE      | OFF       |
| DATA UTIL XFER |           |



- 1) Press the  key once to activate the menu items tab. Press the  key multiple times to tab right, and the  key multiple times to tab left, until the **UTIL** menu is highlighted and displaying the submenu items.
- 2) Use the  and  arrow keys to scroll through the sub menu items until **ALARM** is highlighted.
- 3) Use the  and  arrow keys to toggle the **ALARM** on/off/audible.
- 4) Continue on to the next section “Setting the Alarm Limits”.

### Setting the Alarm Limits





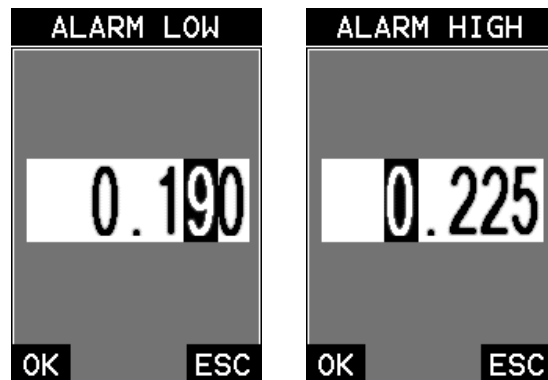

| UTILITIES        |              |
|------------------|--------------|
| AUTO FIND        |              |
| SCAN MODE        | ON           |
| ALARM            | ON           |
| ALARM HIGH       | 0.225        |
| <b>ALARM LOW</b> | <b>0.190</b> |
| DIFFERENTIAL     | OFF          |
| KEY CLICK        | QUIET        |
| SET DATE         | MMDDYY       |
| SHOW DATE        | OFF          |
| DATA UTIL XFER   |              |

| UTILITIES         |              |
|-------------------|--------------|
| AUTO FIND         |              |
| SCAN MODE         | ON           |
| ALARM             | ON           |
| <b>ALARM HIGH</b> | <b>0.225</b> |
| ALARM LOW         | 0.750        |
| DIFFERENTIAL      | OFF          |
| KEY CLICK         | QUIET        |
| SET DATE          | MMDDYY       |
| SHOW DATE         | OFF          |
| DATA UTIL XFER    |              |

- 1) Assuming the **ALARM** is **ON**, use the  and  arrow keys to scroll through the sub menu items until **ALARM** is highlighted.

- 2) Press the  and  arrow keys to scroll the value. When the correct alarm value is being displayed, **proceed to step 7.**



- 3) **Alternatively**, press the  key to display the **Digits Edit Box**.
- 4) Press the  and  arrow keys to scroll the highlighted value.
- 5) Press the  and  arrow keys to scroll the digit locations.
- 6) Repeat steps 4 & 5 until the **ALARM** value is correctly displayed.
- 7) Press the  key to return to the measurement screen and begin taking readings.







## 9.16 Differential Mode

The **Differential Mode** of the *HPX* provides the user with the ability to set a nominal value, according to what the expected thickness should be, and measure the +/- difference from the nominal value entered. This feature is typically used for quality inspections of incoming parts, or inspection during the manufacturing process.

The steps below outline how to enable and set a nominal value:

### Activating Diff Mode (on/off)





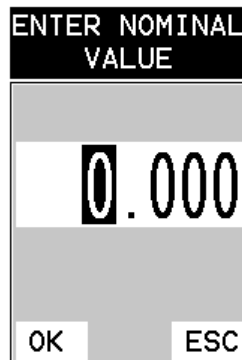

| UTILITIES           |              |
|---------------------|--------------|
| AUTO FIND           |              |
| SCAN MODE           | OFF          |
| ALARM               | ON           |
| ALARM HIGH          | 0.225        |
| ALARM LOW           | 0.190        |
| <b>DIFFERENTIAL</b> | <b>0.600</b> |
| KEY CLICK           | QUIET        |
| SET DATE            | MMDDYY       |
| SHOW DATE           | OFF          |
| DATA UTIL XFER      |              |

- 1) Press the  key once to activate the menu items tab. Press the  key multiple times to tab right, and the  key multiple times to tab left, until the **UTIL** menu is highlighted and displaying the submenu items.
- 2) Use the  and  arrow keys to scroll through the sub menu items until **DIFFERENTIAL** is highlighted.
- 3) Use the  and  arrow keys to toggle the **DIFFERENTIAL** on. A value will appear to the right of **DIFFERENTIAL**.
- 4) Continue on to the next section “**Setting the Nominal Value**”.

### Setting the Nominal Value



- 1) Assuming **DIFFERENTIAL** has been enabled and a value is being displayed to the right of the **DIFFERENTIAL** label, press the  key to display the **Digits Edit Box**.

- 2) Press the  and  arrow keys to scroll the highlighted value.
- 3) Press the  and  arrow keys to scroll the digit locations.
- 4) Repeat steps 2 & 3 until the **DIFFERENTIAL** value is correctly displayed.
- 5) Press the  key to set the **DIFFERENTIAL** value and return to the menu screen.
- 6) Finally, press the  key to return to the measurement screen and begin taking readings.





### 9.17 Key Click

When a key is pressed on the **HPX** keypad, the user can control whether or not an audible beep is sounded and at what volume level, if any.



The procedure for this feature/preference is outlined below:

**Setting the Key Click**

| UTILITIES        |              |
|------------------|--------------|
| AUTO FIND        |              |
| SCAN MODE        | OFF          |
| ALARM            | ON           |
| ALARM HIGH       | 1.000        |
| ALARM LOW        | 0.000        |
| DIFFERENTIAL     | OFF          |
| GAUGE            | THICKNESS    |
| <b>KEY CLICK</b> | <b>QUIET</b> |
| SET DATE         | MDDYY        |
| SHOW DATE        | BOTH         |
| DATA UTIL        | XFER         |

- 1) Press the  key once to activate the menu items tab. Press the  key multiple times to tab right and the  key multiple times to tab left until the **UTIL** menu is highlighted and displaying the submenu items.
- 2) Use the  and  arrow keys to scroll through the sub menu items until **KEY CLICK** is highlighted.



- 3) Use the  and  arrow keys to toggle the **KEY CLICK** loud/quiet/off.
- 4) Press the  key to return to the measurement screen and begin taking readings.





## 9.18 Set Date & Time

The **HPX** is equipped with an internal clock to time and date stamp the log, setup and screen capture files for reporting/documentation purposes.

The procedures for setting the time and date are outlined below:





### Setting Date & Time

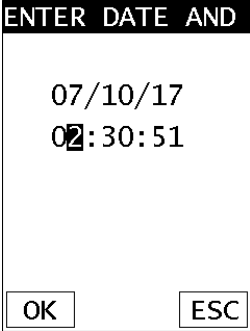

| UTILITIES       |               |
|-----------------|---------------|
| AUTO FIND       |               |
| SCAN MODE       | OFF           |
| ALARM           | ON            |
| ALARM HIGH      | 1.000         |
| ALARM LOW       | 0.000         |
| DIFFERENTIAL    | OFF           |
| GAUGE           | THICKNESS     |
| KEY CLICK       | QUIET         |
| <b>SET DATE</b> | <b>MMDDYY</b> |
| SHOW DATE       | BOTH          |
| DATA            | UTIL XFER     |

- 1) Press the  key once to activate the menu items tab. Press the  key multiple times to tab right and the  key multiple times to tab left until the **UTIL** menu is highlighted and displaying the submenu items.
- 2) Use the  and  arrow keys to scroll through the sub menu items until **SET DATE** is highlighted.





3) Press the  key to display the **Digits Edit Box**.

4) Press the     arrow keys to scroll the field locations.

5) Press the  and  arrow keys multiple times to scroll the value.

6) Repeat steps **4 & 5** until the **Time & Date** is correctly displayed.

7) Press the  key to set the **Time & Date** and return to the menu screen, or  to cancel entering the **Time & Date**.

8) Finally, press the  key to return to the measurement screen and begin taking readings.









## 9.19 Show Date & Time

The **HPX** can be configured to show the date & time in the active A-Scan window as needed or preferred (off/date/time/both).

The procedure for activating and displaying the above options are outlined below:

### Live Time & Date

| UTILITIES    |             |
|--------------|-------------|
| AUTO FIND    |             |
| SCAN MODE    | OFF         |
| ALARM        | OFF         |
| ALARM HIGH   | 1.000       |
| ALARM LOW    | 0.000       |
| DIFFERENTIAL | OFF         |
| GAUGE        | THICKNESS   |
| KEY CLICK    | QUIET       |
| SET DATE     | MMDDYY      |
| SHOW DATE    | <b>BOTH</b> |
| DATA         | UTIL XFER   |

- 1) Press the  key once to activate the menu items tab. Press the  key multiple times to tab right and the  key multiple times to tab left until the **UTIL** menu is highlighted and displaying the submenu items.
- 2) Use the  and  arrow keys to scroll through the sub menu items until **SHOW DATE** is highlighted.
- 3) Press the  and  arrow keys to scroll the options (Date, Time, Both, Off).
- 4) Finally, press the  key to return to the measurement screen and begin taking readings.

## 9.20 Capture to File



The capture feature enables a user to capture the last viewed screen, give it a unique name, and save it to the internal SD card in the **HPX**. The screenshot will be saved as a tagged interface file (.tif), and can be viewed directly on the gauge, or using any PC graphics software viewer. This is a handy feature for presentations or training media, as well as general field captures.

The procedure to capture the last screen displayed is outlined below:

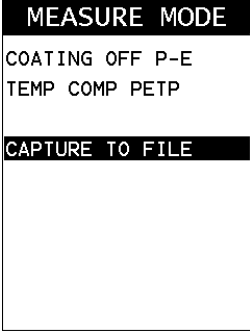
### Capturing Screen Shots



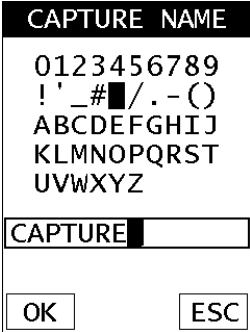

The image shows a screen with a black header 'MEASURE MODE'. Below it, the text 'COATING OFF P-E' and 'TEMP COMP PETP' is displayed. At the bottom, 'CAPTURE TO FILE' is highlighted in black.

- 1) To capture a file, press the **MULT MODE** key to freeze the screen and enter the measure mode list.
- 2) Press the  and  arrow keys until **CAPTURE TO FILE** is highlighted.



The image shows a screen with a black header 'CAPTURE NAME'. Below it, the following characters are listed: '0123456789', '! '\_# / . - ( )', 'ABCDEFGHIJ', 'KLMNOPQRST', and 'UVWXYZ'. At the bottom, 'CAPTURE' is highlighted in black. Below the list are two buttons: 'OK' and 'ESC'.

- 3) Press the  key to display the alpha numeric edit box to name and save the screen shot.
- 4) Press the  key to return to the measurement screen.





## 9.21 Capture Viewer

The capture viewer enables a user to view any of the saved screen captures on the SD card, using the **HPX**. This is handy if a PC isn't available, but the user has a need to review the screen shots captured.

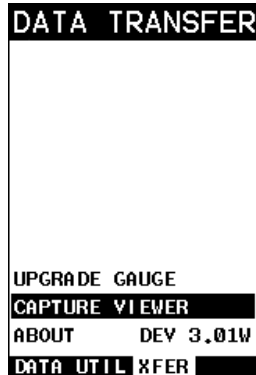



The procedure to capture the last screen displayed is outlined below:

### Using the Viewer

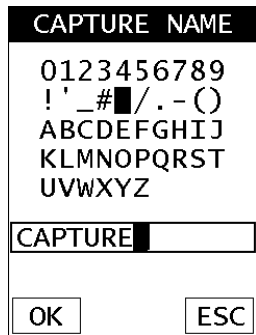

- 1) Press the  key once to activate the menu items tab. Press the  key multiple times to tab right and the  key multiple times to tab left until the **XFER** menu is highlighted and displaying the submenu items.
- 2) Press the  and  arrow keys until **CAPTURE VIEWER** is highlighted.



- 3) Press the  key to display the list of images saved on the SD card.
- 4) Use the  and  arrow keys to scroll through the list until the desired image name is highlighted.
- 5) Press the  key to display the image.
- 6) Press the  key to return to the measurement screen.

## CHAPTER TEN

### DATA STORAGE – SETUP, EDIT, & VIEW FILES

#### 10.1 Introduction to Grid and Sequential file formats

The **HPX** is equipped with two data file format options, **GRID LOG** and **SEQ LOG**. The **GRID** file format is very similar to a spreadsheet format found in popular software programs like Excel. A **GRID** is simply a table of readings. A location in a grid is specified by giving a row and column coordinate. The rows are numbered from 1 to 999 and the columns are labeled from A to ZZ (999 Rows & 52 Columns). The sequential file format can be viewed as a file as a single column of up to 512 possible rows (readings), and a column of corresponding identifiers associated with each individual reading. The identifier can be a combination of up to 10 numeric, alpha, or special characters listed above, while the file name can consist of a combination of up to 20 of the same character set. Note: *The identifier cannot start or end with a special character.* Once a start and end ID are entered into the **HPX** and the log created, the **HPX** will automatically generate all the identifiers within that range.

The following character set listed below are all the allowable characters that will be used for both file formats: **GRID & SEQ LOG**. Any combination of these characters can be used for creating a Name and Note regardless of the selected format. The allowable characters are as follows:

**Numeric characters:** 0 – 9 **Alpha Characters:** A – Z

**Special Characters:** ! ' \_ # space / . - ( )

Multiple grids can be created and stored until the **HPX**'s memory is full. If the user attempts to store a new file in the **HPX** and the size of the file exceeds the capacity of memory, the **HPX** will respond with an error message indicating that the memory is unable to store the new file.

The **HPX** has a 4gb SD memory card for virtually unlimited storage capacity. Along with every measurement stored, is a corresponding screenshot of the **DIGITS**, **RF**, **RECT**, or **B-SCAN** views, as well as all the **HPX** settings for every individual measurement. The screenshot stored with the reading will depend on what view the **HPX** was in at the time it was saved. For example, if the view was in **RECT**, then a **RECT** waveform will be saved with the reading.

In the sections that follow, the procedures for creating, using, and editing **GRID's** and **SEQ LOG's** have been combined together for the purpose of similarity in overall functionality and structure. The illustrations below are snapshots of typical **GRID** and **SEQ LOG** file formats:

### Grid File Formats

| NAME: EX#1 |   |   |   | NAME: EX#2 |   |   |   |
|------------|---|---|---|------------|---|---|---|
|            | A | B | C |            | D | E | F |
| 1          |   |   |   | 6          |   |   |   |
| 2          |   |   |   | 7          |   |   |   |
| 3          |   |   |   | 8          |   |   |   |
| 4          |   |   |   | 9          |   |   |   |

### Sequential Log Formats

| NAME: EX#1 |  | NAME: EX#2 |  |
|------------|--|------------|--|
| AA         |  | 01         |  |
| AB         |  | 02         |  |
| AC         |  | 03         |  |
| AD         |  | 04         |  |
| AE         |  | 05         |  |

| NAME: EX#3 |  | NAME: EX#4 |  |
|------------|--|------------|--|
| 3A         |  | BCD-4-01   |  |
| 3B         |  | BCD-4-02   |  |
| 3C         |  | BCD-4-03   |  |
| 3D         |  | BCD-4-04   |  |
| 3E         |  | BCD-4-05   |  |

**Note:** For the duration of this chapter, all references to **GRIDS** and **SEQ LOGS** should be considered synonymous with references to **FILES**.

## 10.2 Creating a new Grid or Sequential Log (File)

This entire section is a step by step guide to successfully create a grid or sequential log.

The instructions must be used in the sequential order specified, as follows:

### Creating a Name



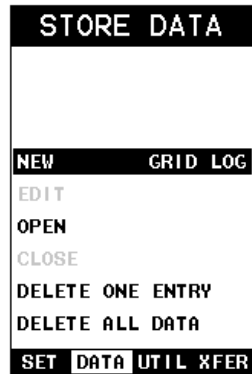



**Grid/Seq Log Name** : Can contain a combination of up to 20 numeric, alpha, or special characters listed in the first section of this chapter.



**Grid Log**



**Sequential Log**

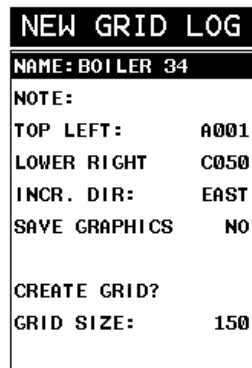

- 1) Press the  key once to activate the menu items tab. Press the  key multiple times to tab right, and the  key multiple times to tab left, until the **DATA** menu is highlighted and displaying the submenu items.
- 2) Use the  and  arrow keys to scroll through the sub menu items until **NEW** is highlighted.
- 3) Press the  and  arrow keys to toggle the data formats – **GRIG LOG** & **SEQ LOG**.

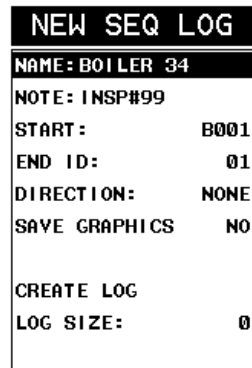

**Grid Log**











**Sequential Log**

- 4) Press the  key to display the new **Grid** or **Seq Edit Box**.
- 5) Use the  and  arrow keys to scroll through the new **Grid** or **Seq List Items** until **NAME** is highlighted.





- 6) Press the  key to activate the **Alpha Edit Box**.
- 7) Use the     arrow keys to highlight the appropriate alpha characters.
- 8) Press the  key to select a character and advance to the next field of the **Grid** or **Seq Name**.
- 9) Use the  key to backspace if necessary.
- 10) Repeat steps 6 - 9 until the **Grid** or **Seq Name (File Name)** is completed.
- 11) Press the  key to save the **Grid** or **Seq Name** and return to the **Grid** or **Seq List Items** menu, or  to cancel entering the **Grid** or **Seq Name (File Name)**.

### Creating a Note



**Grid/Seq Log Note:** Can contain a combination of up to 20 numeric, alpha, or special characters listed in the first section of this chapter.

| NEW GRID LOG  |           |
|---------------|-----------|
| NAME:         | BOILER 34 |
| NOTE:         | INSP#99   |
| TOP LEFT:     | A001      |
| LOWER RIGHT   | A001      |
| INCR. DIR:    | NONE      |
| SAVE GRAPHICS | NO        |
| CREATE GRID?  |           |
| GRID SIZE:    | 1         |

**Grid Log**

| NEW SEQ LOG   |           |
|---------------|-----------|
| NAME:         | BOILER 34 |
| NOTE:         | INSP#99   |
| START:        | B001      |
| END ID:       | 01        |
| DIRECTION:    | NONE      |
| SAVE GRAPHICS | NO        |
| CREATE LOG    |           |
| LOG SIZE:     | 0         |

**Sequential Log**





1) Assuming the **Grid** or **Seq** List Items are displayed, use the  and  arrow keys to scroll through the new **Grid** or **Seq List Items** until **NOTE** is highlighted.

2) Press the  key to activate the **Alpha Edit Box**.

| LOG NOTE            |
|---------------------|
| 0123456789          |
| ! ' _ # █ / . - ( ) |
| A B C D E F G H I J |
| K L M N O P Q R S T |
| U V W X Y Z         |
| INSP#99 █           |

**OK**



**ESC**

3) Use the , , ,  arrow keys to highlight the appropriate alpha characters.

4) Press the  key to select a character and advance to the next field of the **Grid** or **Seq Note**.

5) Use the  key to backspace if necessary.

6) Repeat steps 3 through 5 until the **Grid** or **Seq Note** is completed.

- 7) Press the  key to save the **Grid** or **Seq Note** and return to the **Grid** or **Seq List Items** menu, or  to cancel entering the **Grid** or **Seq Note**.

### Setting the Coordinates or Start & Stop ID's

**Grid:** A grid is defined by using coordinates to define the **Top Left** and the **Bottom Right** corners of the grid. Alpha coordinates are horizontal across the top, and numeric coordinates are vertical down the side. Therefore, to define the top left corner of the grid, there will be an (X,Y) coordinate. Where X is an alpha column location across the top and Y is a numeric row location down the side. Use the same logic when choosing the lower right corner. An individual grid can be up to 999 rows and 52 columns.

**Sequential:** The sequential file format can be viewed as a file as a single column of up to 512 possible rows (readings), and a column of corresponding identifiers associated with each individual reading. The identifier can be a combination of up to 10 numeric, alpha, or special characters listed above, while the file name can consist of a combination of up to 20 of the same character set. Note: *The identifier cannot start or end with a special character.* Once a start and end ID are entered into the **HPX** and the log created, the **HPX** will automatically generate all the identifiers within that range.



### Setting the Top Left(Grid) or Start ID(Seq)

| NEW GRID LOG   |           |
|----------------|-----------|
| NAME:          | BOILER 34 |
| NOTE:          | INSP#99   |
| TOP LEFT:      | A001      |
| LOWER RIGHT:   | A001      |
| INCR. DIR:     | NONE      |
| SAVE GRAPHICS: | NO        |
| CREATE GRID?:  |           |
| GRID SIZE:     | 1         |

Grid Log

| NEW SEQ LOG    |           |
|----------------|-----------|
| NAME:          | BOILER 34 |
| NOTE:          |           |
| START:         | B001      |
| END ID:        | 01        |
| DIRECTION:     | NONE      |
| SAVE GRAPHICS: | NO        |
| CREATE LOG:    |           |
| LOG SIZE:      | 0         |

Sequential Log





- Use the  and  arrow keys to scroll through the new **Grid** or **Seq List Items** until **TOP LEFT** or **START ID** is highlighted.
- Press the  key to activate the **Coordinate** or **Start ID Edit Box**.







| ENTER TOP LEFT VALUE |     |
|----------------------|-----|
| A001                 |     |
| OK                   | ESC |



Grid Log

| START ADDR  |     |
|---|-----|
| 0123456789<br>! ' _ # / . - ( )<br>ABCDEFGHIJ<br>KLMNOPQRST<br>UVWXYZ |     |
| B001  |     |
| OK  | ESC |

Sequential Log

- GRID LOG:** Use the  and  arrow keys to scroll the **Columns**, and the  and  arrow keys to scroll the **Rows**.

**SEQ LOG:** Use the     arrow keys to highlight the appropriate alpha characters. Press the  key to select a character and advance to the next character field, in conjunction with using the  key to backspace if necessary.

- 4) Press the  key to select the coordinate or start ID and return to the **Grid** or **Seq List Items** screen, or  to cancel the selection and return to the **Grid** or **Seq List Items** menu.



**Setting the Bottom Right(Grid) or End ID(Seq)**

| NEW GRID LOG       |             |
|--------------------|-------------|
| NAME:              | BOILER 34   |
| NOTE:              | INSP#99     |
| TOP LEFT:          | A001        |
| <b>LOWER RIGHT</b> | <b>C050</b> |
| INCR. DIR:         | NONE        |
| SAVE GRAPHICS      | NO          |
| CREATE GRID?       |             |
| GRID SIZE:         | 150         |

**Grid Log**

| NEW SEQ LOG    |             |
|----------------|-------------|
| NAME:          | BOILER 34   |
| NOTE:          | INSP#99     |
| START:         | B001        |
| <b>END ID:</b> | <b>B150</b> |
| DIRECTION:     | NONE        |
| SAVE GRAPHICS  | NO          |
| CREATE LOG     |             |
| LOG SIZE:      | 150         |

**Sequential Log**





- 5) Use the  and  arrow keys to scroll through the new **Grid** or **Seq List Items** until **LOWER RIGHT** or **END ID** is highlighted.
- 6) Press the  key to activate the **Coordinate** or **End ID Edit Box**.

| BOTTOM RIGHT VALUE |     |
|--------------------|-----|
| C050               |     |
| OK                 | ESC |



**Grid Log**



| STOP ADDR         |     |
|-------------------|-----|
| 0123456789        |     |
| ! ' _ # / . - ( ) |     |
| ABCDEFGHIJ        |     |
| KLMNOPQRST        |     |
| UVWXYZ            |     |
| B150              |     |
| OK                | ESC |



**Sequential Log**

- 7) **GRID LOG:** Use the  and  arrow keys to scroll the **Columns**, and the  and  arrow keys to scroll the **Rows**.

**SEQ LOG:** Use the , , , and  arrow keys to highlight the

appropriate alpha characters. Press the  key to select a character and advance to the next character field, in conjunction with using the  key to backspace if necessary.

- 8) Press the  key to select the coordinate or end ID and return to the **Grid** or **Seq List Items** screen, or  to cancel the selection and return to the **Grid** or **Seq List Items** menu.

**Note:** *If there is not enough memory available to create the grid or sequential log, an error message box “**NOT ENOUGH MEMORY**“ will be displayed. Press the  or  key to return to the **Grid** or **Seq List Items** menu. It may be necessary to free some memory in the **HPX** at this time. Refer to page 109 for more information on **Deleting a File**.*

### Selecting the Auto Increment Direction



The **Auto Increment** feature gives the user the ability to specify which direction to advance the cursor after storing a reading.



| NEW GRID LOG      |             |
|-------------------|-------------|
| NAME:             | BOILER 34   |
| NOTE:             | INSP#99     |
| TOP LEFT:         | A001        |
| LOWER RIGHT       | C050        |
| <b>INCR. DIR:</b> | <b>EAST</b> |
| SAVE GRAPHICS     | NO          |
| CREATE GRID?      |             |
| GRID SIZE:        | 150         |

**Grid Log**

| NEW SEQ LOG       |            |
|-------------------|------------|
| NAME:             | BOILER 34  |
| NOTE:             | INSP#99    |
| START:            | B001       |
| END ID:           | B150       |
| <b>DIRECTION:</b> | <b>INC</b> |
| SAVE GRAPHICS     | NO         |
| CREATE LOG        |            |
| LOG SIZE:         | 150        |

**Sequential Log**

- 1) Use the  and  arrow keys to scroll through the new **Grid** or **Seq List Items** until **INCR. DIR** or **DIRECTION** is highlighted.

- 2) Use the  and  arrow keys to toggle the **Increment** direction **NONE**, **NORTH**, **EAST**, **SOUTH**, or **WEST** for a grid, or **INC**, **DEC** for a sequential log.
- 3) Continue on to the next section “**Saving a Grid or Seq File**”.

### Saving a Grid



Once all the parameters are set, the user has the option of saving or canceling the new grid.

| NEW GRID LOG  |           |
|---------------|-----------|
| NAME:         | BOILER 34 |
| NOTE:         | INSP#99   |
| TOP LEFT:     | A001      |
| LOWER RIGHT   | C050      |
| INCR. DIR:    | EAST      |
| SAVE GRAPHICS | NO        |
| CREATE GRID?  |           |
| GRID SIZE:    | 150       |

**Grid Log**

| NEW SEQ LOG   |           |
|---------------|-----------|
| NAME:         | BOILER 34 |
| NOTE:         | INSP#99   |
| START:        | B001      |
| END ID:       | B150      |
| DIRECTION:    | INC       |
| SAVE GRAPHICS | NO        |
| CREATE LOG    |           |
| LOG SIZE:     | 150       |

**Sequential Log**



- 1) Use the  and  arrow keys to scroll through the new **Grid** or **Seq List Items** until **CREATE GRID** or **LOG?** is highlighted.
- 2) Press the  key to accept the grid or seq log parameters and activate the confirmation screen.

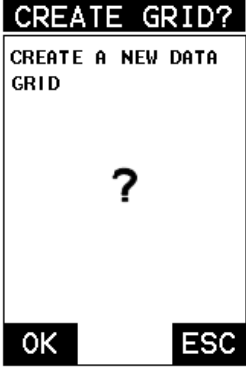

**Grid Log**



**Sequential Log**

3) Press the  key to save the **New Grid** or **Seq Log**, or the  key to cancel **the New Grid or Seq Log** setup and return to the **DATA** menu.

4) Press the  key to return to the measurement screen and begin storing readings.

### 10.3 Storing a reading







Now that a grid or sequential log has been created, it's time to make some measurements and store the readings.

The following procedures outline this process:

### Storing a Reading

**Note:** *Once the grid or sequential log has been created it will automatically be displayed following the create confirmation screen. It is located at the bottom of the measurement screen, and can be left open for the duration of the inspection process. This section assumes the grid or sequential log was just created. Refer to the section on "opening a grid or seq log" if the file was created at another time.*



**Key Feature:** When the HPX is displaying a “grid log”, pressing the  key will initiate an advance to row number option. Use the     arrow keys to enter the row number. Once the row number is correctly displayed, press the  key to advance directly to that row number in the grid log.



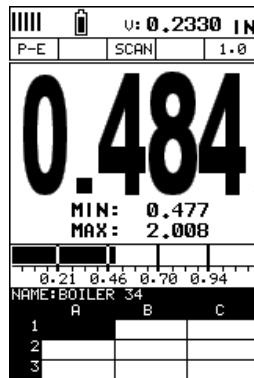

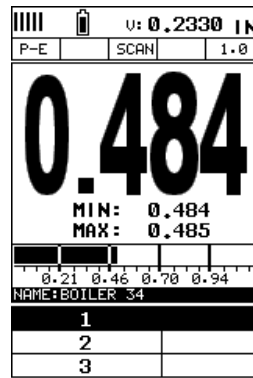

**Key Feature:** When the HPX is displaying a “grid log”, pressing the  key multiple times, will toggle through the display options: **Digits**, **RF**, **RECT**, and **B-SCAN** views.



Grid Log



Sequential Log

- 1) Press the     arrow keys to scroll the target cell cursor to the desired storage location.
- 2) Press the  key to save the current reading in the highlighted cell location. It's as simple as that!
- 3) Press the  key to hide the **GRID/SEQ View Box**, or  to display it as necessary.

**Note:** Once the file is open, it will remain open until it's closed or another file is opened by the user. If the gauge is powered off, the HPX will automatically

open the file when powered on. Simply press the  key to display the file from the measurement screen.

### 10.4 Viewing stored readings

It is sometimes necessary to go back and view the stored readings and B-Scans using the **HPX** without a PC.

The following procedures outline this process:

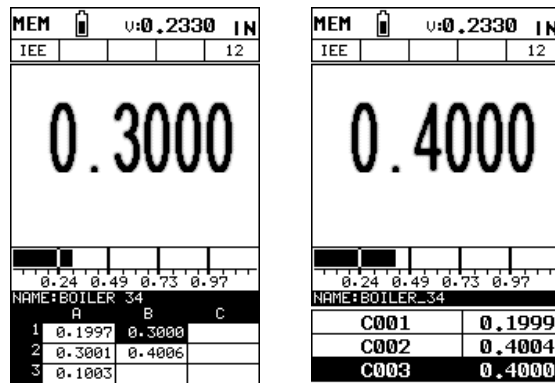

#### Viewing Stored Readings & A/B Scans



Grid Log







Sequential Log

|        |       |          |       |
|--------|-------|----------|-------|
| DELAY: | 0.779 | RANGE:   | 1.214 |
| AGC:   | 12    | THRESH1: | 7     |
| START: | 0.200 | WIDTH1:  | OFF   |
| HOLD2: | 0.064 | LOG:     | B003  |

- 1) Press the  key once to activate measure menu items. Press the  key multiple times to move right and the  key multiple times to move left until the **LOG** cell is highlighted.

| NAME: GRID LOG |       |       |   |
|----------------|-------|-------|---|
|                | A     | B     | C |
| 1              | 0.273 | 0.300 |   |
| 2              | 0.523 |       |   |
| 3              |       |       |   |
| 4              |       |       |   |

- 2) Press the  key to display the **Grid Log Box**.



- 3) Press the     arrow keys to scroll the stored readings and corresponding display view. Notice as the cursor is moved to a different cell, the display will be updated with the display view saved with the reading. Readings stored in memory are indicated by displaying a **MEM** in the top left corner of the measurement screen.
- 4) The user may opt to clear a specific reading and save a new one at any time. Press the  key in the appropriate cell location to clear the reading, take a new measurement, and press the  key to save the new reading.
- 5) Abort the **Grid/Seq Log View Box** by pressing the  key at any time.

## 10.5 Deleting Grids (Files)



This section covers deleting files to clean up the SD memory. The files can be individually deleted, or the entire memory cleared by deleting all the files in the gauge.

The procedures are outlined below as follows:



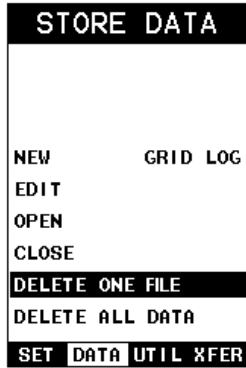

### Deleting One File

- 1) Press the  key once to activate the menu items tab. Press the  key multiple times to tab right and the  key multiple times to tab left until the **DATA** menu is highlighted and displaying the submenu items.

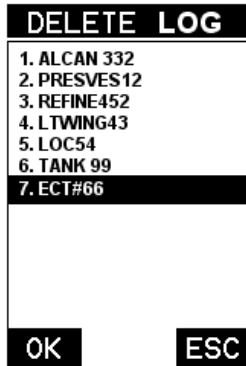



- 2) Use the  and  arrow keys to scroll through the sub menu items until **DELETE ONE FILE** is highlighted.





- 3) Press the  key to display the **File List Box**.
- 4) Use the  and  arrow keys to scroll through the stored **Files** until the target **File** to delete is highlighted.
- 5) Press the  key to delete the **File**.
- 6) Press the  key to return to the measurement screen.



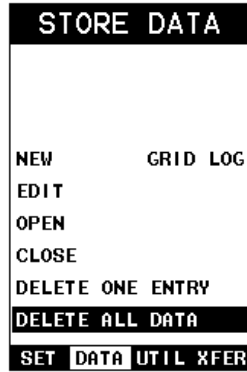

### Deleting All Data

- 1) Press the  key once to activate the menu items tab. Press the  key multiple times to tab right and the  key multiple times to tab left until the **DATA** menu is highlighted and displaying the submenu items.

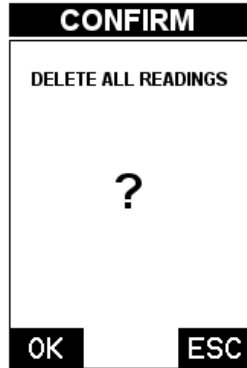

- 2) Use the  and  arrow keys to scroll through the sub menu items until **DELETE ALL DATA** is highlighted.



- 3) Press the  key to activate the confirmation screen.
- 4) Press the  key to delete **All Files** from memory, or the  key to abort.
- 5) Press the  key to return to the measurement screen.









## 10.6 Editing a Grid (File)



Once a grid has been created and saved to memory, the user can edit the **Name**, **Comments** and **Increment Direction** at a later time.

The following procedure outlines this process:

### Editing a Grid







| EDIT GRID LOG |           |
|---------------|-----------|
| NAME:         | BOILER 34 |
| NOTE:         |           |
| TOP LEFT:     | A001      |
| LOWER RIGHT   | C010      |
| INCR DIR:     | SOUTH     |
| SAVE CHANGES? |           |
| LOG SIZE      | 30        |

- 1) Press the  key once to activate the menu items tab. Press the  key multiple times to tab right and the  key multiple times to tab left until the **DATA** menu is highlighted and displaying the submenu items.
- 2) Use the  and  arrow keys to scroll through the sub menu items until **EDIT** is highlighted.
- 3) Press the  key to display the **Edit List Box**.
- 4) Use the  and  arrow keys to scroll through the **Edit** options until **NAME**, **NOTE**, or **INCR. DIR** is highlighted.



**Note:** If editing the **INCR. DIR**, simply use the  and  arrow keys to scroll **NONE**, **NORTH**, **EAST**, **SOUTH**, **WEST** for a Grid, or **INC**, **DEC** for a Seq Log.

**Proceed to step 10.**

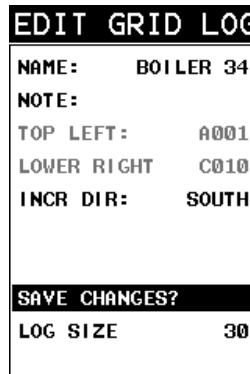

- 5) Press the  key to activate the **Alpha Edit box – Only used when editing the NOTE.**
- 6) Use the     arrow keys to highlight the appropriate alpha characters.
- 7) Press the  key to select a character and advance to the next field of the **Comments.**
- 8) Use the  key to backspace if necessary.
- 9) Repeat steps 6 - 8 until the **Comments** are completed.



- 10) Press the  and  arrow key to highlight **SAVE CHANGES**, and the  key to activate the confirmation screen.

DATA LOG

OVERWRITE  
CURRENT  
GRID

?

OK

ESC

11) Press the OK key to save the changes or the ESC key to cancel editing the file parameters.

12) Press the MEAS key to return to the measurement screen.

### 10.7 Changing the active File - Open

The user may have transferred grid/seq templates from a PC to the **HPX**, or setup grids/seq using the **HPX** at an earlier time. The name of the currently active file is always displayed at the top of the **Grid/Seq Box** in measurement mode (refer to photo below). It's not only important to recognize what file is currently active, but also be able to change the active file at any time.

The following procedure outlines this process:

### Opening a File

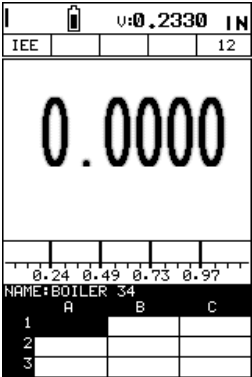

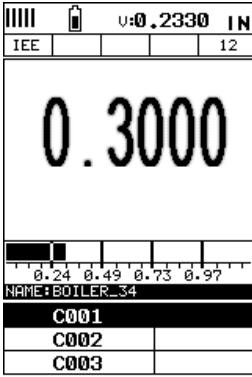

**Grid Log**





**Sequential Log**





- 1) Press the  key once to activate the menu items tab. Press the  key multiple times to tab right and the  key multiple times to tab left until the **DATA** menu is highlighted and displaying the submenu items.



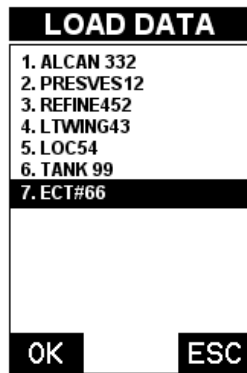

- 2) Use the  and  arrow keys to scroll through the sub menu items until **OPEN** is highlighted.

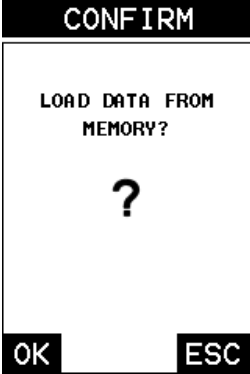

- 3) Press the  key to display the **Grid/Seq List Box**.
- 4) Use the  and  arrow keys to scroll through the grids until the target grid is highlighted.



5) Press the  key to activate the confirmation screen.

6) Press the  key to load the file from memory.



7) Press the  key to return to the measure screen.

## 10.8 Closing an active File - Close



If data storage will not be needed during an inspection, the active file currently open can be closed.

The following procedure outlines how to close an active file:

**Closing a File**

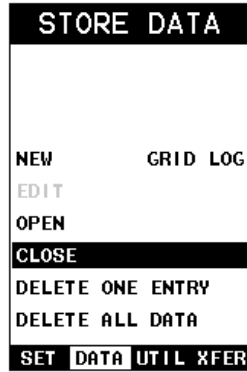
1) Press the  key once to activate the menu items tab. Press the  key multiple times to tab right and the  key multiple times to tab left until the **DATA** menu is highlighted and displaying the submenu items.



- 2) Use the  and  arrow keys to scroll through the sub menu items until **CLOSE** is highlighted.

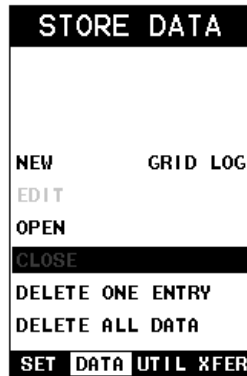

- 3) Press the  key to close the active file. **Note:** *Following the key press, the **CLOSE** text will be grayed out indicating the file has been close and is no longer active.*

## CHAPTER ELEVEN SETUPS – CREATE, STORE, EDIT, & RECALL

### 11.1 Introduction to Setups

It's very common that a user may be tasked to perform continual inspections for multiple applications on a repeated basis, with different settings and calibrations. The **HPX** is equipped with the ability to create, name and store 64 custom setups. These setups can be recalled at any time for a given application. The setup file can be bi-directionally transferred to and from a PC, and multiple setup files can be created and cataloged on a given PC or server.





### 11.2 Opening a Setup

If multiple setups have been created and stored in memory, they can quickly be opened in active memory at any time. Once opened, all settings and calibrations previously performed are ready for use.

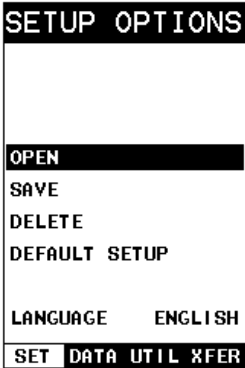
The following procedure outlines how to open factory and custom setups:

**Opening a Setup**



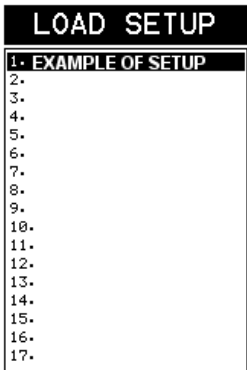

- 1) Press the  key once to activate the menu items tab. Press the  key multiple times to tab right and the  key multiple times to tab left until the **SETUP** menu is highlighted and displaying the submenu items.
- 2) Use the  and  arrow keys to scroll through the sub menu items until **OPEN** is highlighted.



**LOAD SETUP**

1. EXAMPLE OF SETUP  
2.  
3.  
4.  
5.  
6.  
7.  
8.  
9.  
10.  
11.  
12.  
13.  
14.  
15.  
16.  
17.

3) Press the  key to display the **Setup List Box**.

4) Use the  and  arrow keys to scroll through the setups until the target setup name is highlighted.

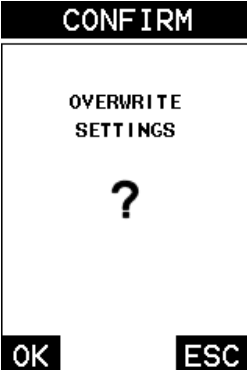



**CONFIRM**

OVERWRITE  
SETTINGS

?

OK      ESC

5) Press the  key to activate the confirmation screen.

6) Press the  key to load the setup from memory.

7) Press the  key to return to the measure screen.

### 11.3 Saving & Editing a Setup





Once the *HPX* parameters and features have been adjusted for an application, the user may elect to save these setting, with a unique name, to a specific setup location for future use.

It is sometimes necessary to rename a previously saved setup, or add additional comments about a particular setup. The setup name may have been entered incorrectly, or the user needs to use the setup for a completely different project. An inspector's name or other comments about the project may also be required for additional documentation purposes.

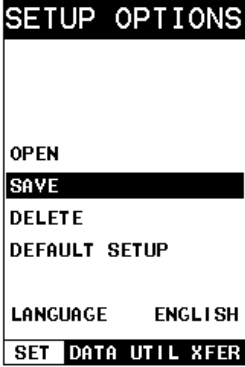
The following procedure outlines the necessary steps for saving and editing a setup:

### Saving a Setup



- 1) Press the  key once to activate the menu items tab. Press the  key multiple times to tab right and the  key multiple times to tab left until the **SETUP** menu is highlighted and displaying the submenu items.
- 2) Use the  and  arrow keys to scroll through the sub menu items until **SAVE** is highlighted.

**SAVE SETUP**

NAME: EX#1

NOTE:



SAVE SETUP

**SAVE SETUP**









NAME: EX#1

NOTE: INSP#99



SAVE SETUP

- 3) Press the  key to display the **Save Setup Parameters List Box**.
- 4) Press the  and  arrow keys to scroll the **Name** and **Note** parameters.



| SETUP NAME  | SETUP NOTE  |
|---|---|
| 0123456789<br>! ' _ # █ / . - ( )<br>ABCDEFGHIJ<br>KLMNOPQRST<br>UVWXYZ | 0123456789<br>! ' _ # █ / . - ( )<br>ABCDEFGHIJ<br>KLMNOPQRST<br>UVWXYZ |
| EX#1 █  | INSP#99 █   |
| OK      ESC   | OK      ESC   |

- 5) When the parameter to edit is highlighted, press the  key to activate the **Alpha Edit Box**.
- 6) Use the     arrow keys to scroll through the characters, the  key to select characters, and the  key to backspace through the characters, until the **Name** or **Note** fields have been edited.
- 7) Press the  key to return to the **Save Setup Parameters List Box**.
- 8) If both parameters will be edited, **repeat steps 4 – 7**.

| SAVE SETUP                  |
|-----------------------------|
| NAME: EX#1<br>NOTE: INSP#99 |
| SAVE SETUP                  |
|                             |

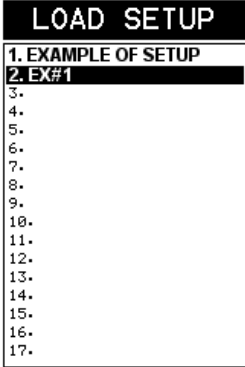

- 9) Use the  and  arrow keys to scroll to and highlight **SAVE SETUP**.
- 10) Press the  key to activate the **Setup List Box**.

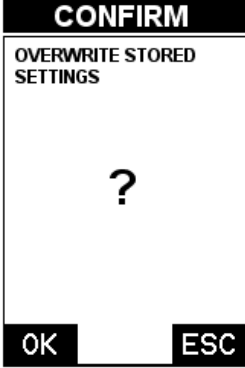

11) Use the  and  arrow keys to scroll through the setups until the target location to save the **Setup** is highlighted.



12) Press the  key to activate the confirmation screen.

13) Press the  key to save the **Setup**, or  to cancel saving the **Setup**.

14) Finally, press the  key to return to the measurement screen.

**Note:** The **Name** and **Comments** of the **Setup** can be edited at any time by simply repeating the **Save Setup** routine described above. Therefore, the **Save Setup** function can also be considered an **Edit Function**.





## 11.4 Deleting a Saved Setup

This option allows a user to delete setup files that were previously saved and no longer needed. It's a simple feature to allow the user to do a bit of "house cleaning".

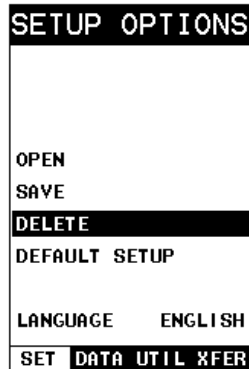





## Deleting a Setup

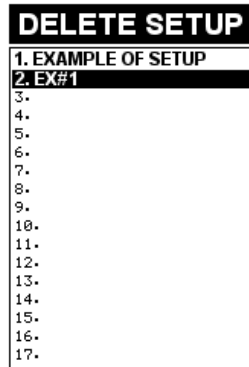



- 1) Press the  key once to activate the menu items tab. Press the  key multiple times to tab right and the  key multiple times to tab left until the **SETUP** menu is highlighted and displaying the submenu items.
- 2) Use the  and  arrow keys to scroll through the sub menu items until **DELETE** is highlighted.

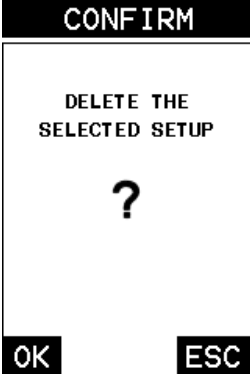

- 3) Press the  key to display the **Setups List**.
- 4) Press the  and  arrow keys to scroll to the **Setup Name**.
- 5) When the **Setup Name** is highlighted, press the  key to display the confirmation screen.



6) Press the  key to delete the **Setup File**.

7) Finally, press the  key to return to the measurement screen.





### 11.5 Using the Default Setup

The default setup feature was added to the **HPX** to use, as a last resort, if there are no setups stored in the gauge –factory or otherwise. The only time this might possibly occur is if the setup file in the **HPX** was somehow corrupted, and the user does not have access to a computer to re-load the factory setups back into the **HPX**. This gives the user the ability to load and modify a basic setup as follows:

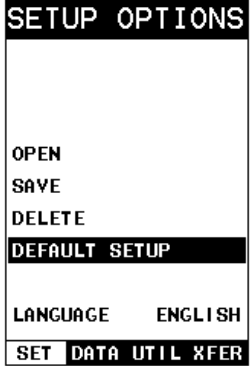
**Note:** The default file contains no probe zero data. Therefore, a zero must be performed after loading. Also, the default setup can be loaded when using the flaw mode feature, to eliminate the probe zero delay value, and start at the initial pulse or zero.

**Using the Default Setup**











- 1) Press the  key once to activate the menu items tab. Press the  key multiple times to tab right and the  key multiple times to tab left until the **SETUP** menu is highlighted and displaying the submenu items.
- 2) Use the  and  arrow keys to scroll through the sub menu items until **DEFAULT SETUP** is highlighted.

## 11.6 Selecting a Language

The **HPX** is equipped with a language option. Currently, the only languages supported are English, Spanish, German, French, Hungarian, Czech, however the list continues to grow. Check with Dakota for an updated list. The steps to select one of these languages are outlined as follows:

### Selecting a Language



- 1) Press the  key once to activate the menu items tab. Press the  key multiple times to tab right and the  key multiple times to tab left until the **SETUP** menu is highlighted and displaying the submenu items.
- 2) Use the  and  arrow keys to scroll through the sub menu items until **LANGUAGE** is highlighted.
- 3) Press the  and  arrow keys to toggle the language options.

4) Once the desired language is displayed, press the  key to return to the measurement screen.

## CHAPTER TWELVE USING THE UTILITY SOFTWARE

### 12.1 Computer System Requirements

**DakView** will run on many different operating systems: Windows XP, Windows 2000 Professional, Windows 2000 Server, Windows 2000, Vista, Windows 7, 8, 10, or advanced Server operating systems running on Intel or AMD hardware. Additionally there is a version for the Mac OSX platform.

A Pentium 166MHz or faster processor with at least 32 megabytes of physical RAM is required. You should have 40 megabytes of free disk space before attempting to install **DakView**.

File transfer is standard USB connectivity, using a USB-C to USB transfer cable (pt# N-003-0330).

### 12.2 Installing DakView

**DakView** is available directly from our website for download free of charge. Stay current by periodically checking the website for the latest version. Simply download the .exe file from our website to your computer, and double click the icon to begin installation. Refer to the online help section in **DakView** for operating instructions.

### 12.3 Communicating with the HPX

**DakView** will not directly communicate with the **HPX** series gauges. The **HPX** is equipped with USB, acting as a Thumb Drive (external storage device) when connected to a computer and powered on. Therefore, the SD memory card can be opened as a drive with *directory structure, similar to the C: on your computer*. The files stored on the internal SD can be simply copied (dragged) into any folder on your PC and opened using **DakView**. The PC software will function as a file viewer for the **HPX** series gauges.

### 12.4 Line Power





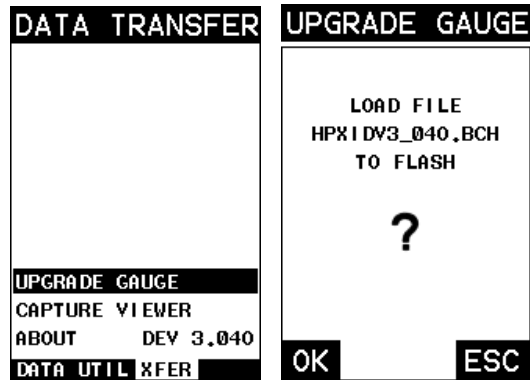

The **HPX** can be powered using the standard USB-C to USB-A data cable (N-003-0330), by connecting directly to a USB port on your computer, or using a standard cell phone power adapter directly to an outlet. This is a convenient way to power the gauge for specific bench top applications in a factory line environment.

### 12.5 Upgrading the HPX

The **HPX** can be upgraded to the latest revision of firmware at any time. Simply download the latest version posted on the Dakota Ultrasonics website, copy the upgrade file to the main drive directory **HPX**, and use the upgrade utility located in the **XFER** menu. The process is very easy and convenient, allowing our users to stay current with updated feature additions and bug fixes. The procedure to upgrade your **HPX** is outlined below:

## Upgrading the Firmware



- 1) Press the  key once to activate the menu items tab. Press the  key multiple times to tab right and the  key multiple times to tab left until the **XFER** menu is highlighted and displaying the submenu items.
- 2) Use the  and  arrow keys to scroll through the sub menu items until **UPGRADE GAUGE** is highlighted.
- 3) Press the  key to display the upgrade confirmation screen, followed by pressing  key to start the upgrade process, or es to exit the upgrade.

**Note:** *The HPX will power down during the upgrade process and the illuminate the alarm lights. The upgrade is completed once the lights stop flashing. Do not interrupt the upgrade process and be sure there is sufficient battery life, if not powering by AC.*

## APPENDIX A - VELOCITY TABLE

| Material          | sound velocity<br>in/us |          | sound velocity<br>m/s |
|-------------------|-------------------------|----------|-----------------------|
| Aluminum          | 0.2510                  |          | 6375                  |
| Beryllium         | 0.5080                  |          | 12903                 |
| Brass             | 0.1730                  |          | 4394                  |
| Bronze            | 0.1390                  |          | 3531                  |
| Cadmium           | 0.1090                  |          | 2769                  |
| Columbium         | 0.1940                  |          | 4928                  |
| Copper            | 0.1830                  |          | 4648                  |
| Glass (plate)     | 0.2270                  |          | 5766                  |
| Glycerine         | 0.0760                  |          | 1930                  |
| Gold              | 0.1280                  |          | 3251                  |
| Inconel           | 0.2290                  |          | 5817                  |
| Iron              | 0.2320                  |          | 5893                  |
| Cast Iron         | 0.1800                  | (approx) | 4572                  |
| Lead              | 0.0850                  |          | 2159                  |
| Magnesium         | 0.2300                  |          | 5842                  |
| Mercury           | 0.0570                  |          | 1448                  |
| Molybdenum        | 0.2460                  |          | 6248                  |
| Monel             | 0.2110                  |          | 5359                  |
| Nickel            | 0.2220                  |          | 5639                  |
| Nylon             | 0.1060                  | (approx) | 2692                  |
| Platinum          | 0.1560                  |          | 3962                  |
| Plexiglas         | 0.1060                  |          | 2692                  |
| Polystyrene       | 0.0920                  |          | 2337                  |
| PVC               | 0.0940                  |          | 2388                  |
| Quartz glass      | 0.2260                  |          | 5740                  |
| Rubber vulcanized | 0.0910                  |          | 2311                  |
| Silver            | 0.1420                  |          | 3607                  |
| Steel (1020)      | 0.2320                  |          | 5893                  |
| Steel (4340)      | 0.2330                  |          | 5918                  |
| Steel Stainless"  | 0.2230                  |          | 5664                  |
| Teflon            | 0.0540                  |          | 1372                  |

|                  |               |  |             |
|------------------|---------------|--|-------------|
| <b>Tin</b>       | <b>0.1310</b> |  | <b>3327</b> |
| <b>Titanium</b>  | <b>0.2400</b> |  | <b>6096</b> |
| <b>Tungsten</b>  | <b>0.2040</b> |  | <b>5182</b> |
| <b>Uranium</b>   | <b>0.1330</b> |  | <b>3378</b> |
| <b>Water</b>     | <b>0.0580</b> |  | <b>1473</b> |
| <b>Zinc</b>      | <b>0.1660</b> |  | <b>4216</b> |
| <b>Zirconium</b> | <b>0.1830</b> |  | <b>4648</b> |



## APPENDIX B - SETUP LIBRARY

| Num | Name              | Comment 1 | Gn/AGC | Velocity |
|-----|-------------------|-----------|--------|----------|
| 1   | Enter Custom Name |           |        |          |
| 2   | ...               |           |        |          |
| 3   | ...               |           |        |          |
| 4   | ...               |           |        |          |
| 5   | ...               |           |        |          |
| 6   | ...               |           |        |          |
| ... | ...               |           |        |          |
|     |                   |           |        |          |
|     |                   |           |        |          |
|     |                   |           |        |          |
|     |                   |           |        |          |
|     |                   |           |        |          |
|     |                   |           |        |          |
|     |                   |           |        |          |
|     |                   |           |        |          |
|     |                   |           |        |          |
|     |                   |           |        |          |
|     |                   |           |        |          |
|     |                   |           |        |          |

# WARRANTY INFORMATION

## • Warranty Statement •

Dakota Ultrasonics warrants the **HPX** against defects in materials and workmanship for a period of two years from receipt by the end user. Additionally, Dakota Ultrasonics warrants transducers and accessories against such defects for a period of 90 days from receipt by the end user. If Dakota Ultrasonics receives notice of such defects during the warranty period, Dakota Ultrasonics will either, at its option, repair or replace products that prove to be defective.

Should Dakota Ultrasonics be unable to repair or replace the product within a reasonable amount of time, the customer's alternative exclusive remedy shall be refund of the purchase price upon return of the product.

## • Exclusions •

The above warranty shall not apply to defects resulting from: improper or inadequate maintenance by the customer; unauthorized modification or misuse; or operation outside the environmental specifications for the product.

Dakota Ultrasonics makes no other warranty, either express or implied, with respect to this product. Dakota Ultrasonics specifically disclaims any implied warranties of merchantability or fitness for a particular purpose. Some states or provinces do not allow limitations on the duration of an implied warranty, so the above limitation or exclusion may not apply to you. However, any implied warranty of merchantability or fitness is limited to the five-year duration of this written warranty.

This warranty gives you specific legal rights, and you may also have other rights which may vary from state to state or province to province.

## • Obtaining Service During Warranty Period •

If your hardware should fail during the warranty period, contact Dakota Ultrasonics and arrange for servicing of the product. Retain proof of purchase in order to obtain warranty service.

For products that require servicing, Dakota Ultrasonics may use one of the following methods:

- Repair the product
- Replace the product with a re-manufactured unit
- Replace the product with a product of equal or greater performance
- Refund the purchase price.

## • After the Warranty Period •

If your hardware should fail after the warranty period, contact Dakota Ultrasonics for details of the services available, and to arrange for non-warranty service.

NDT Supply.com, Inc.  
7952 Nieman Road  
Lenexa, KS 66214-1560 USA  
Phone: 913-685-0675, Fax: 913-685-1125  
e-mail: [sales@ndtsupply.com](mailto:sales@ndtsupply.com), [www.ndtsupply.com](http://www.ndtsupply.com)

