

Technical Manual /Operating Instructions

MiniTest 7200 FH / MiniTest 7400 FH

Thickness Gauges



7952 Nieman Road, Lenexa, KS 66214-1560 USA
Phone: 913-685-0675, Fax: 913-685-1125
www.ndtsupply.com, sales@ndtsupply.com

Contents

1. INTRODUCTION.....5

2. FIRST STEPS.....6

 2.1 INSERT BATTERIES AND CONNECT SENSOR6

 2.2 SWITCH ON AND TAKE READINGS.....7

 2.2.1 *Setting language*.....7

3. DESCRIPTION OF THE MEASURING SYSTEM.....9

 3.1 BASIC UNIT9

 3.1.1 *General Remarks*.....9

 3.1.2 *Operating keys*9

 3.1.3 *Sockets and interfaces*.....10

 3.1.4 *Power supply*.....10

 3.1.4.1 *Batteries and storage batteries*10

 3.1.4.2 *Power supply unit*.....11

 3.2 SENSORS FH 4 AND FH 10.....11

 3.2.1 *General Remarks*.....11

 3.2.2 *Sensor Models*.....11

 3.2.3 *Sensor Stand*.....12

4. THE USER MENU.....13

 4.1 GENERAL REMARKS13

 4.2 SWITCH-ON / START SCREEN13

 4.3 MEASURE SCREEN /STATISTICS SCREENS13

 4.3.1 *Measure Mode – Numerical Screen*.....13

 4.3.2 *Measure Mode –Graphics Screen with MiniTest 7400 FH*14

 4.3.3 *Statistics Screens*.....14

 4.4 USER MENU15

 4.4.1 USER PREFERENCES15

 4.4.2 NUMERICAL ENTRIES16

 4.4.3 ALPHANUMERICAL ENTRIES (ON MINITEST 7400 FH).....16

5. MEASURE MODE17

 5.1 IMPORTANT NOTES ON THICKNESS MEASUREMENT.....17

 5.1.1 *Limitations to magneto-static thickness measurement*.....17

 5.2 BATCH CONFIGURATION / NECESSARY SETTINGS.....17

 5.2.1 *Batch*17

 5.2.2 *Target Ball Size*.....18

 5.2.3 *Data Logging Mode*18

 5.3 PREPARING MEASUREMENT18

 5.3.1 *Calibration*.....18

 5.3.2 *Measurement without Sensor Stand*.....19

 5.3.3 *Using the Sensor Stand*.....19

 5.4 TAKE READINGS19

 5.4.1 *Measurement without Sensor Stand*.....19

 5.4.2 *Using the sensor stand*.....20

 5.4.3 *Delete Readings*20

 5.5 STORING READINGS INTO STATISTICS MEMORY20

 5.5.1 *Data Logging Mode*20

 5.5.2 *Manual Data Storage*.....21

5.5.3 Automatic Data Storage (Auto).....	21
5.5.4 Storing Minimum Reading	21
5.5.5 Storing Maximum Reading.....	21
5.6.1 Correct Sensor Position	22
5.6.2. Incorrect Readings through tilting of the Sensor.....	22
5.6.3 Incorrect readings through Blocked Target Ball.....	23
5.6.4 Air gap.....	23
5.6.5 Measuring material with ferruginous particles	23
6. CALIBRATION	24
6.1 GENERAL REMARKS ON CALIBRATION	24
6.2 CALIBRATION METHODS.....	25
6.3 HOW TO CALIBRATE	26
6.3.1 Factory Calibration	26
6.3.2 Zero only.....	26
6.3.3 Multi-point calibration (Zero + 1 to 4 point(s)).....	27
6.4. DELETE CALIBRATION POINT	28
6.5 CALIBRATION ERROR SOURCES	29
7. DATA STORAGE.....	30
7.1 BATCHES.....	30
7.1.1 General.....	30
7.1.2 Batch Data	30
7.2 DATABASE OF THE MINITEST 7400 FH.....	31
7.2.1 General Remarks.....	31
7.2.2 Tree structure.....	31
7.2.3 Create a Directory	31
7.2.4 Create a New Batch	32
7.2.5 Select a Batch for Measurement	32
7.2.6 Delete a Batch / a Directory	33
7.2.7 Rename a Batch / Rename a Directory.....	33
8. STATISTICS	34
8.1 STATISTICAL PARAMETERS	34
8.1.1 Upper and lower specifications limits (USL and LSL).....	34
8.1.2 Set Point (Differential Mode).....	35
8.2 READINGS	35
8.2.1 View Readings.....	35
8.2.2 Delete Single Readings	35
8.2.3 Delete all Readings	36
8.3 NUMERICAL STATISTICS	36
8.4 HISTOGRAM ON MINITEST 7400 FH	37
8.5 TREND DIAGRAM ON MINITEST 7400 FH	37
9. DATA OUTPUT / DATA TRANSFER.....	38
9.1 DATA PRINT-OUT.....	38
9.1.1 Screen Shot.....	39
9.1.2 Print-out a Batch.....	39
9.2 TRANSFER DATA TO A PC	40
10. MAIN MENU	41
10.1 DATABASE	41

10.2 STATISTICS.....	41
10.3 CALIBRATION.....	41
10.4 ACTIVE BATCH	41
10.4.1 <i>Batch Properties</i>	41
10.4.2 <i>Readings</i>	42
10.4.3 <i>Configuration</i>	42
10.4.4 <i>Calibration</i>	42
10.5 SETUP.....	43
10.5.1 <i>General Remarks</i>	43
10.5.2 <i>Display</i>	43
10.5.3 <i>Date and Time</i>	43
10.5.4 <i>Data Outputs</i>	44
10.5.5 <i>User Preferences</i>	45
10.5.6 <i>Gauge Specifications</i>	45
11. SPECIAL FUNCTIONS.....	46
11.1 INITIALIZING	46
11.2 SPECIAL FUNCTIONS	47
12. QUICK REFERENCE	48
13. CARE AND MAINTENANCE.....	49
13.1 CARE.....	49
13.1.1 <i>Using NiMH storage batteries</i>	49
13.2 MAINTENANCE	49
14. TECHNICAL SPECIFICATION.....	50
14.1 GAUGE AND SENSOR SPECIFICATION	50
14.2 DELIVERY SCHEDULE	52
14.2.1 <i>Thickness gauge MiniTest 7200 FH / 7400 FH</i>	52
14.2.2 <i>Sensors</i>	52
14.3 ACCESSORIES	53
15. APPENDIX.....	56
15.1 TROUBLESHOOTING.....	56
15.2 DETECTION OF ERROR SOURCES (INF FLAG)	59
15.3 STATISTICAL TERMS	60
15.4 SAFETY NOTES.....	62
15.5 DECLARATION OF CONFORMITY	64
15.6 AFTER SALES SERVICE	65
INDEX.....	66

1. Introduction

Designed for non-destructive thickness measurement, the portable MiniTest 7200 / 7400 FH measuring systems are suitable for in the field or laboratory use. Working on the magneto-static principle, the gauges enable quick and easy measurement on non-ferromagnetic materials.

The measuring system consists of a handy sensor, which is connected via a cable to the base and display unit for visualization and processing of readings. For measurement, specially treated target balls made of a ferromagnetic material are used as a reference. For measurement, a target ball is placed on the material to be measured so that the material thickness between target ball and sensor will be measured. The measuring system comes with sensor stand (available as an option) to add additional comfort of handling during measurement.

For documentation a portable data printer is available. The measuring system may also be connected to a PC for data communication.

For taking readings, the sensor is placed on the surface of the measuring object, the target ball is placed on the opposite side of sample. The sensor is placed on the opposite side of sample. Equipped with a strong permanent magnet, the sensor attracts the target ball and holds it exactly over its sensor tip. When moving the sensor, the target follows accordingly. The presence of the target ball will change the magnetic field near the sensor tip. The magnetic field changes according to the distance between target ball and sensor tip. The change of magnetic field increases with the distance between target ball and sensor tip getting smaller and can be taken as a reference for the material thickness of the sample to be measured. The sensor incorporates a Hall element to capture the change of magnetic field and to translate it into thickness.

For measuring hollow parts, a target ball is placed into the interior of sample and the sensor is placed on the opposite side in order to attract the target ball exactly over the sensor tip. For taking readings, the sensor is moved over the surface of sample. For measuring sheets, the sensor is placed on the surface of sheet and the target ball is placed near the sensor on the opposite side of sheet. The target ball will automatically center on the correct measuring position and the measuring processes can be started.

For measuring large-sized parts, the sensor can be guided manually over the sample to be measured. For measuring small parts, it is recommended to use the sensor stand supplied with the sensor.

Suitable for use in industrial production areas, the measuring systems MiniTest 7200 / 7400 FH measure hollow parts, containers and sheet material of all kinds such as bottles, cans, injections moldings, car bodies, glass, SMC components etc made of non-magnetic (non-ferrite) materials.

2. First Steps

This section refers to persons to use the gauge for the first time. This section explains the main features of the gauge and how to take readings.

2.1 Insert Batteries and connect Sensor

- a) Take gauge and batteries from the carrying case.
- b) Push the battery compartment lid at the gauge bottom in arrow direction (as shown below)
- c) Insert batteries into the battery compartment. Respect polarities (as shown below).
- d) Close lid.

b)

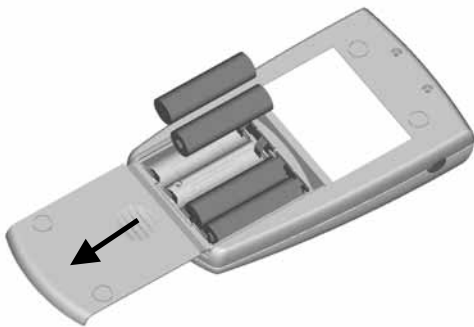

c)

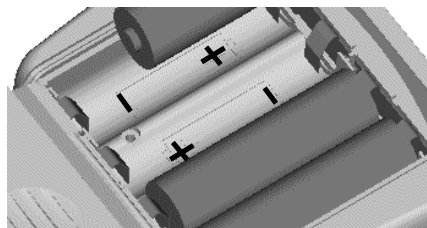

- e) Take requested sensor (FH4 or FH10) from the carrying case. Plug sensor into the socket on top of the base unit (as shown below). Make sure the nib of plug is correctly inserted into the guide way of socket. The red marking at the probe plug must be positioned correctly to the red marking at the sensor plug.

- f) Fully engage the sensor plug into the sensor socket to the stop.

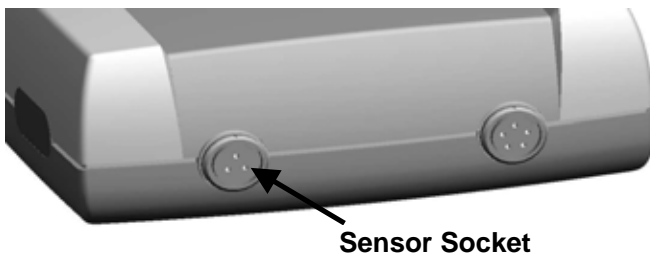

2.2 Switch ON and Take Readings

2.2.1 Setting language

This setting can be made at initial use or as requested at any time (see section 11.1)

Press the red ON/OFF button on the left side of gauge and ESC simultaneously to switch on and to go to initialization menu.

1. A banner appears with a language option.
User arrow keys $\uparrow\downarrow$ to go to your requested language option.
Press OK to confirm or ESC to abort.
2. On display appears "Total Reset". A Total Reset restores factory settings. To abort Total Reset, press Function key "No" (section 11.1)

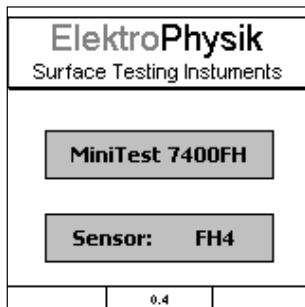

- a) **Start Screen** appears showing company logo, gauge version and sensor type that is currently connected (see illustr. on the left).
- b) After approx. 2 seconds, the gauge switches automatically into measure mode and is ready to take readings. The **Measure Screen** will appear without any reading being shown.
- c) At initial switch-on the gauge is in "Direct Mode" (see section 7.1.1). For this mode, the factory calibration is preset (for more detailed information on "Calibration" topics please refer to section 6). The Status Line provides information on the active calibration method and the active batch (MiniTest 7400 FH) Please check whether the target ball size as adjusted matches your application (for more details on target ball size please refer to section 5.2.2 "Target ball size").

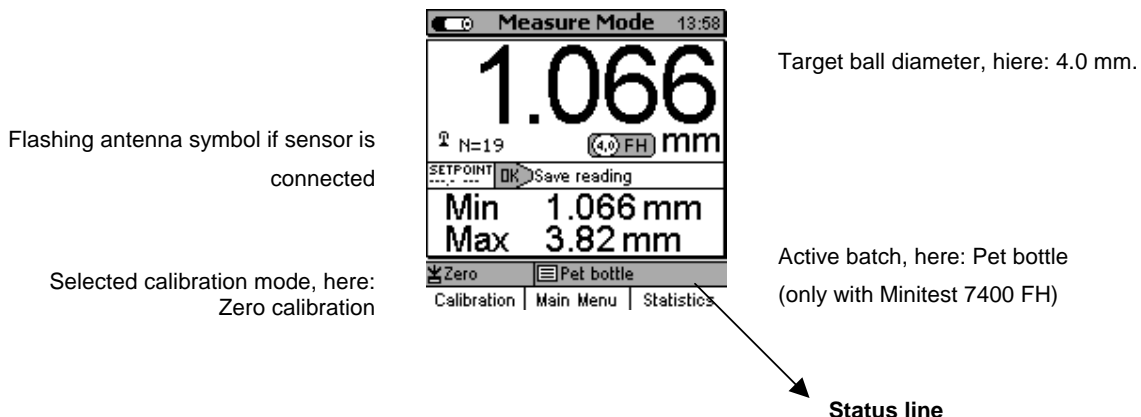

-
- d) The factory calibration is for quick and easy measurement when larger measuring errors are acceptable. For other calibration methods please refer to section 6.2.
 - e) For measurement, please use the sensor stand supplied with the gauge. Place the measuring object on the sensor. Place the target ball on the opposite side. For measuring hollow parts, place the ball inside the sample. Equipped with a strong permanent magnet, the sensor attracts the target ball and holds it exactly over its sensor tip. Hold the measuring object in rectangular position to the sensor and move it smoothly over the sensor. Press OK to store the reading into memory. Press Function key "Statistics" to view readings and the numerical statistics.

For measuring large-sized sheeting material or large hollow parts, place the sensor on the surface of sample. The target ball is placed on the opposite side near the sensor. Keep the sensor in rectangular position to the surface and move it across the surface of sample.

3. Description of the measuring system

3.1 Basic unit

3.1.1 General Remarks

Graphics display
160 x 160 Dots



Large backlit display for easy reading of measuring values, statistical data, histogram and trend diagram.

Robust scratch resistant plastics housing.

3.1.2 Operating keys

ON/OFF button

Command and
navigation key
block



Function keys

Use the **ON/OFF button** to switch the gauge ON or OFF. If you press ON/OFF button and ESC simultaneously, the initializing procedure will be performed (for more details please refer to section 11.1).

The **Function keys** may assume different functions according to the menu being active. Their current properties are displayed in the line upper to the Function keys.

The **command and navigation key block** may also assume different functions:

- Press OK to confirm settings, store values or select menu items.
- Press ESC to abort actions or to quit submenus.
- Use ARROW keys to navigate through the menu or change settings.
- If the alphanumeric block has been activated, OK and ESC keys also assume navigation functions.

The Function keys and the command and navigation key block may be backlit on request. This adds additional comfort in poor light conditions (for more details please refer to section 10.5.2)

Press the “**Help**” **Function key** for calling the context-oriented on-line “Help“.

3.1.3 Sockets and interfaces



The basic unit features a sensor socket for connecting the FH 4 or the FH 10 sensor. The multi-purpose socket is used for connecting the mains unit, the foot switch, the alarm device or the RS232 interface cable.

3.1.4 Power supply

3.1.4.1 Batteries and storage batteries

Both models, MiniTest 7400 FH and MiniTest 7200 FH, are powered by a set of four alkaline-manganese cells, 1.5V, AA LR6 size (Batteries included in the standard supply schedule.).

As an alternative, both models may be operated on rechargeable NiMH (type AA-HR6) storage batteries or via a power supply unit (available as an option). Please use only products as recommended by ElektroPhysik (See section 14.3, Accessories).

If you wish to use the storage batteries, they must be recharge using the external charger unit (available as an option). Please also refer to section 13.1 “Care and maintenance” for more details.

Note:

- Remove batteries or storage batteries from the instrument if you are not going to use it for a longer period of time.
- The battery symbol on display indicates the battery state.
- For field use, replacement batteries should be made available.
- Erratic readings due to low battery voltage do not occur because the gauge switches off or does not switch on if the battery is too low.

-
- Used or defective batteries or storage batteries may contain hazardous substances and must be disposed according to the legal provisions of your country.

3.1.4.2 Power supply unit

For mains operation, the power supply unit must be used. If operated via the power supply unit, batteries should be inserted to supply the internal time clock, otherwise, after approx. 1 minute, the settings of the real-time clock will go lost as soon as supply from the mains is cut.

The power supply unit comes with two different adapter plug versions (Euro and US plug). If the power supply unit comes with an adapter plug connected that does not match your socket, simply change the adapter plug accordingly.

Simply remove the adapter from the power supply unit and fix the other one as required.

Note:

The adapter has not been designed for frequent change.

3.2 Sensors FH 4 and FH 10

3.2.1 General Remarks

In this new SIDSP (Sensor integrated digital signal processing) procedure, all necessary measuring signals are created and completely processed in the sensor itself. Only the completely processed digital readings are transferred to the base unit for display, statistical evaluation and data storage. Unlike the commonly used analog procedures, the new SIDSP procedure excludes any error influences on the measuring data during transfer over the probe cable. The result is a measuring accuracy and constancy of readings that has been unmatched so far. The complete sensor technique is integrated into a robust stainless-steel housing.

3.2.2 Sensor Models

Two sensor models are available:

- FH 4 sensor to cover the 0 ...4 mm range
- FH 10 sensor to cover the 0...10 mm range.

Both sensors feature a wear-resistant sensor tip most suitable also for hard materials such as glass, for instance.

3.2.3 Sensor Stand

Both sensor types come with a spring-loaded V-grooved sensor stand. The use of the sensor stand ensures increased reproducibility of readings by adding stability of the sensor during measurement so that even small parts can be measured without problems.

4. The User Menu

4.1 General Remarks

4.2 Switch-ON / Start Screen

At switch on, the company logo, gauge version and type of sensor being connected appear on display.

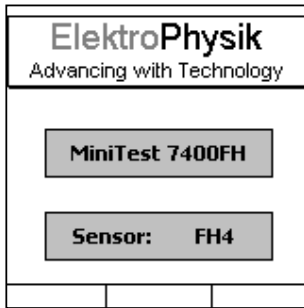

After approx. 2 seconds the gauge switches to the measure screen of the last batch that was active before the gauge was switched off.

4.3 Measure screen /Statistics screens

Readings can be displayed numerically only or numerically combined with a diagram (only with MiniTest 7400 FH)

4.3.1 Measure Mode – Numerical Screen

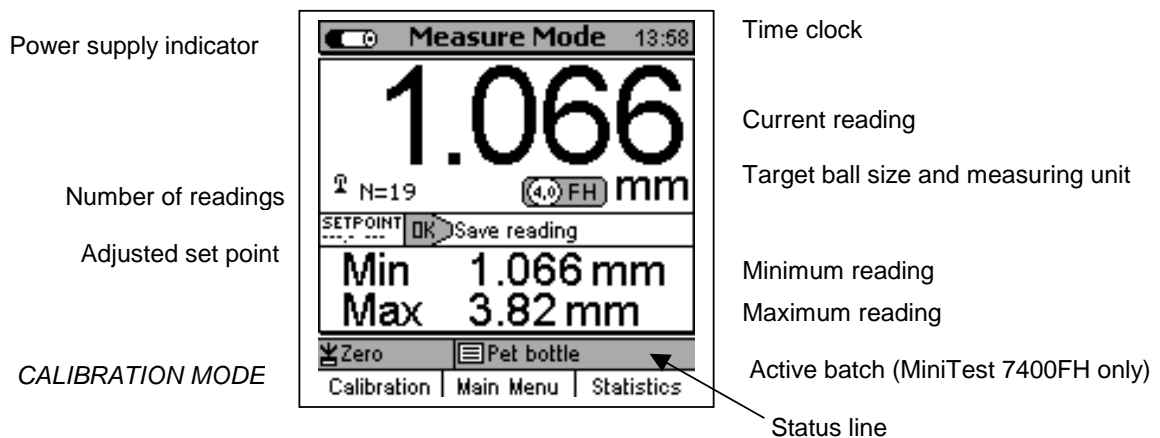

The current **function key** properties are indicated in the line above the function keys.

4.3.2 Measure Mode –Graphics Screen with MiniTest 7400 FH

Power supply indicator

Reading

Set point

REAL-TIME TREND

CALIBRATION METHOD

Time clock

Target ball size, measuring unit

DATA LOGGING MODE

↑ UPPER LIMIT

MAX = MAXIMUM READING

N = NUMBER OF READINGS

MINIMUM READING

↓ LOWER LIMIT

NAME OF ACTIVE BATCH

STATUS LINE

The current **function key** properties are indicated in the line above the function keys.

For setting the Real-Time Trend display option, select “Active Batch” from the Main Menu. Press OK to confirm. Select “Configuration” from the Batch Menu and press OK to confirm. Use the arrow keys to move to the “Graphics” option. ON or OFF is highlighted. Use arrow keys to make your selection and press OK to confirm or the “ESC” navigation button to restore previous setting and to go back to the previous menu level.

To take full advantage of the real-time trend it is necessary to tolerance limits (see also section 8.11 „Upper specification limits (USL) and lower specification limits (LSL)“.

4.3.3 Statistics Screens

Power supply indicator

Time clock

Process capability, cp and cpk

Selected calibration mode

Active batch (MiniTest 7400 FH only)

The current **function key** properties are indicated in the line above the function keys.

4.4 User Menu

The numerous MiniTest FH 7400 / 7200 features can be accessed via the different menus that are divided into submenus.

Press the Function key “**Main menu**“ in order to get access to the main menu.

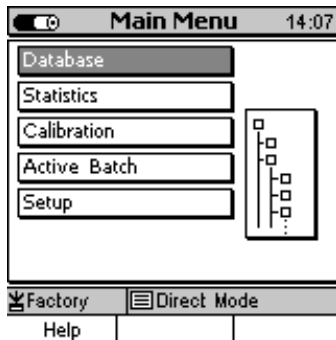

Select an item from the Main Menu (e.g. **Database**) and press OK to confirm. You will go to a submenu. Use the arrow keys to select the requested item and press OK to confirm.

To go back to the previous menu level press ESC.

According selected submenu you can

- View settings (e.g. Gauge specs = Gauge specifications in the Setup Menu)
- Select preset parameters (e.g. 100% brightness from the Display Menu)
- Make numerical or alphanumerical entries (e.g. Enter a directory name in the database / new directory option).

4.4.1 User Preferences

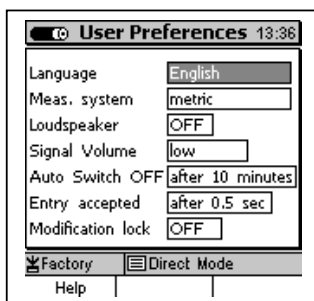

Use the arrow keys to select your requested menu item, e.g. **Language**. Press OK to confirm. The current selection will be highlighted. Use the arrows to select the requested parameter (e.g. English) and press OK to confirm. To undo your selection, press ESC and you will return to the previous menu level.

4.4.2 Numerical Entries

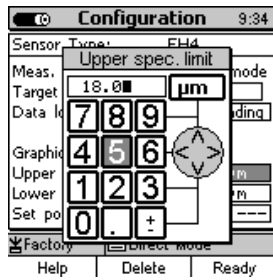

As soon as the alphanumeric block is activated, ESC and OK will assume navigation functions to the left or right. Choose your character by placing the cursor over the requested character. After a certain period of time, the entry will be accepted automatically without the need to confirm. This period of time can be specified under User Preferences in the “Entry accepted” option. See also section 10.5.5 for further reference. Complete your entry by pressing Function key “**Ready**” and then confirm “Save changes?” by pressing **OK**.

4.4.3 Alphanumeric Entries (on MiniTest 7400 FH)



For alphanumeric entries you can use as many as 15 characters for entering a name. ESC and OK assume navigation functions to the left or right. Choose your character via the alphanumeric block. Your selection will be automatically accepted after the previously specified period of time. This period of time can be set under User Preferences in the “Entry accepted” option. See also section 10.5.5 for further reference. Complete your entry by pressing Function key “**Ready**”. Complete your entry by pressing Function key “**Ready**” and then confirm “Save changes?” by pressing **OK**.

5. Measure Mode

5.1 Important Notes on Thickness Measurement

Make sure that the operator has been properly instructed regarding the use of thickness gauges and has basic knowledge of the specific requirements for measurement of the application. The operator should have basic knowledge of the following:

- Selection of a measuring device suitable for his application
- Fundamentals on the magneto-static measuring principle
- Influences on the magnetic fields through the surrounding field
- Influence of the surface properties of the material to be tested (roughness, build-up on the surface)
- Statistical evaluation of measuring series
- Gravity influencing the reference ball

5.1.1 Limitations to magneto-static thickness measurement

The information obtained from thickness measurements according to the magneto-static principle only refer to those parts of the test object that have been covered by the magnetic sensor. For that reason, be careful to draw conclusion on other parts of the measuring object that have not been covered by the sensor during measurement. In general, such conclusions are only admissible if comprehensive experience and approved methods of statistical data acquisition are available.

5.2 Batch Configuration / Necessary Settings

Before taking readings, it is necessary to make a few settings in the Configuration menu. The Configuration always refers to a certain measuring series (Batch).

5.2.1 Batch

- You can continue to take readings in the active batch
- You can create a new batch (only with MiniTest 7400 FH model)
- You can choose an exiting batch from the database (please refer to section 7.2).

5.2.2 Target Ball Size

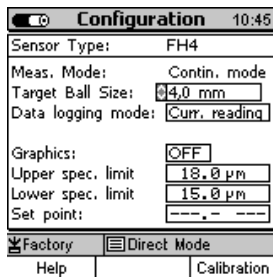

According to sensor type and the shape of measuring object, a suitable target ball must be set. This can be made in the Configuration menu, menu item "Target ball" (also refer to section 6 "Calibration").

Use arrow keys to move to "Target Ball" size and press OK. Use arrow keys to adjust the requested target ball size. Press OK to confirm your setting or press ESC to undo your setting. If you undo, you will automatically quit target ball setting option and go back to the previous menu level.

5.2.3 Data Logging Mode

In the data logging mode you can specify how you wish readings to be stored in memory. Several modes are available:

- manually or via footswitch (Current reading, MIN, MAX)
- Automatic (Auto)

Note: For logging data into memory please always proceed as follows: Put the sensor into the correct measuring position, press ESC. Then readings can be taken.

5.3 Preparing Measurement

Before measurement, the probe must be adapted to the ambient temperature. In case of high variations in temperature, the target ball must be lifted from the probe tip at regular intervals (e.g. every other minute). This is to compensate for frequency drift due to variations in temperature. It is recommended to switch on the gauge for warming up around 2 to 3 minutes in order to ensure maximum measuring accuracy.

5.3.1 Calibration

According to your setting of task, you may use different calibration methods. Measuring accuracy depends on the selected calibration method. Please refer to section 6 for more details on this issue.

There are three calibration methods available:

- Factory
- Zero only
- Multi-point calibration (Zero + 1 to 4 Point(s))

5.3.2 Measurement without Sensor Stand

For measuring large-sized parts, the sensor can be guided manually over the measuring sample. For measuring thick samples (6 mm and thicker) make sure to keep the sensor in vertical position to the sample. When holding the sensor in horizontal position, due to the influence of gravity on the steel ball, the readings will be higher than the actual thickness.

5.3.3 Using the Sensor Stand

For measuring small parts, bottles or other cylindrical bodies the sensor stand (supplied with the sensor) and a footswitch (available as an option) should be used.



Put the sensor into the stand and secure with the red sensor stand retaining ring.

5.4 Take Readings

5.4.1 Measurement without Sensor Stand

For measurements on large-sized sheeting material or large hollow parts, place the sensor onto the surface of the object to be measured. Place an appropriate target ball on the opposite side of object near the sensor. The target ball will be attracted by the strong permanent magnet of sensor and be positioned centrally just opposite of the sensor tip. Keep the sensor in right-angle position to the object to be measured and scan continuously over the surface. For storing readings, please refer to section 5.5.1.



5.4.2 Using the sensor stand

If you are using the sensor stand, position the sample on the sensor tip and keep it in right-angle position to the sensor. Place the appropriate target ball on the opposite side of object. Make sure to keep the right-angle position while moving the object continuously over the sensor. For storing readings, please refer to section 5.5.1.

When measuring small hollow parts such as bottles e.g., put the target ball inside the object and place the object onto the v-grooved device of sensor stand. Turn the object until the target ball is centered directly over the sensor tip. Then move the object continuously over the v-groove of sensor stand. For storing readings, please refer to section 5.5.1.

5.4.3 Delete Readings

Please refer to section 8.2.2 “Delete Single Readings“.

5.5 Storing Readings into Statistics Memory

5.5.1 Data Logging Mode

During measurement, readings can be stored into memory manually or automatically. Data in memory will be used for statistics.

The following storing options are available:

- Storing the current reading manually or automatically
- Storing the minimum reading (only manually)
- Storing the maximum reading (only manually).

The Data logging mode can be specified in the “Configuration” submenu. Use arrow keys to select the **Data logging mode** option and press OK to confirm. You can chose from the following setting options:

- Curr. reading (Current reading)
- Auto
- Max
- Min

Make your selection and press OK to confirm. If you wish to undo your setting (before OK has been pressed) press ESC and the gauge will return to the previous menu level.

5.5.2 Manual Data Storage

During the measuring procedure, current readings can be stored manually into the active batch by pressing OK or by actuating a footswitch. For this option set Data logging mode to “Curr. reading”.

5.5.3 Automatic Data Storage (Auto)

Auto option

In the auto mode, readings will be stored automatically during the measuring procedure as soon as you press OK. To stop the automatic data storage press OK again. If a footswitch is connected, readings are stored as long as the footswitch is actuated.

Before starting the automatic data storage make sure the sensor is placed in the correct measuring position. Make sure to stop the automatic data storage BEFORE the sensor has left the measuring position. This is to avoid erratic readings to be stored into memory that might occur when putting the sensor to or lifting it from the sample.

After setting the Data logging option to the **Auto** option, a **Logging rate** option will appear. The logging rate defines the time intervals at which data will be stored into memory (1, 2, 5, 10 or 20 readings per second). For slow measurement scans, a low logging rate should be set, for quick scanning, the logging rate should be set to a higher rate.

5.5.4 Storing Minimum Reading

In the Minimum option, minimum readings will be stored to the active batch by pressing OK during measurement or by activating a foot switch.

To set Data logging mode to the MIN option, go to the **Configuration** submenu and select Data logging mode. Use arrow keys to select MIN and press OK to confirm. Please note: The minimum reading can also be stored even after the sensor has been lifted from the sample.

5.5.5 Storing Maximum Reading

In the Maximum option, maximum readings will be stored to the active batch by pressing OK during measurement or by activating a footswitch.

To set Data logging mode to the MAX option, go to the **Configuration** submenu and select Data logging mode. Use arrow keys to select MAX and press OK to confirm.

Important note:

- Make sure to put the sensor into the correct measuring position and to press ESC before storing the Maximum reading into memory.
- OK must be pressed BEFORE the sensor is moved from its measuring position.

5.6 Error Sources during Measurement

After calibrating the gauge according to your application and appropriate target ball size, the gauge is ready for measurement.

The readings will be correct as long as you measure within the range as specified for this target ball. The target ball is placed on one side of the sample to be measured and will be attracted by the sensor tip on the other side of the sample. The target ball serves as a reference to the sensor. What is being measured is the distance between sensor and target ball.

Make sure to place both, the sensor tip and the target ball correctly onto the sample. Both must be in good contact with the surface of sample. Otherwise erratic readings (higher readings) might occur. Make sure to keep the sensor in perpendicular position while moving it over the sample. The target ball on the other side must be freely movable.

5.6.1 Correct Sensor Position



The picture illustrates the correct position of sensor tip and steel ball. Make sure to keep the sensor tip perpendicular to the surface of sample.

5.6.2. Incorrect Readings through tilting of the Sensor

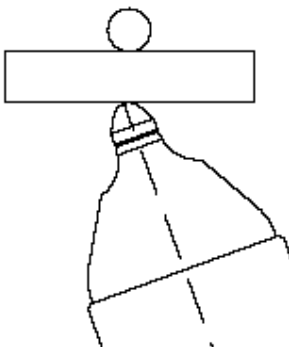

Error source:

The sensor tip is not positioned correctly in perpendicular position to the sample. The reading will therefore be higher than the actual thickness.

Remedy:

Make sure to keep the sensor in perpendicular position to the sample. If necessary, use the sensor stand.

5.6.3 Incorrect readings through Blocked Target Ball

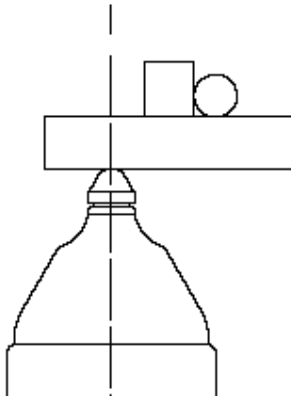

Error source:

The target ball has got stuck through a bulge, e.g. inside the sample. It is out of the correct measuring position.

Remedy:

Move the sample in order to release the target ball.

5.6.4 Air gap

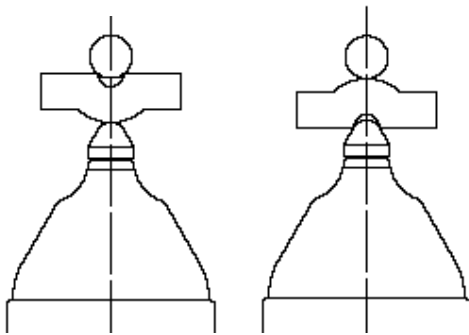

Error source:

Due to the shape of sample, an air gap is between target ball and measuring object. The reading will be higher than the actual thickness.

Remedy:

If the target ball is too large, use a smaller one. If the sensor is not in good contact, change measuring position and use a smaller target ball, if necessary.

5.6.5 Measuring material with ferruginous particles

Ferruginous particles in the material to be measured may lead to erratic readings because the ferruginous particles may influence the measuring signal. This will lead to readings smaller than the actual thickness.

6. Calibration

Calibration is made in the batch being active and will always refer to this batch, i.e. each batch has its own calibration. Before calibration, an appropriate target ball diameter must be set in the **Calibration** menu. Please refer to section 5.2.2 “Target ball size”.

There are two options to go to the Calibration menu:

- from the **Main menu** choose **Calibration**
- from the **Measure Mode menu** press **Calibration** function key.

For selecting an appropriate target ball, the following aspects should be taken into consideration:

- minimum radius of sample to be measured
- maximum thickness to be measured
- required measuring accuracy

Sensor	Target ball to be used	Min. Internal radius of sample	Measuring range	Recommended measuring range
FH 4	Ø 1.5 mm	0.75 mm	0 ... 1.5 mm	0... 1.5 mm
FH 4 / FH 10	Ø 2.5 mm	1.25 mm	0 ... 2.5 mm	1... 2.5 mm
FH 4 / FH 10	Ø 4.0 mm	2.0 mm	0 ... 4.0 mm	2... 4.0 mm
FH 10	Ø 6.0 mm	3.0 mm	0 ... 10 mm	3... 6 mm
FH 10	Ø 9.0 mm	4.5 mm	0 ... 10 mm	6... 10 mm

6.1 General Remarks on Calibration

For achieving maximum accuracy, please observe the following calibration instructions:

- Make sure to keep off strong magnetic fields from the sensor during measurement.
- Keep away from any ferromagnetic metal parts in a safety distance of at least 30 cm.
- It is recommended to switch on the gauge for warming up around 2 to 3 minutes before starting calibration procedure.
- Make sure the sensor tip, target balls and calibration standards are clean. Any foreign matter may lead to erratic readings.
- For maximum accuracy of calibration and later measurements, choose the thickness of calibration standard within the same thickness range as the later measuring sample.
- In some cases it may become necessary to recalibrate if a new target ball is used (also if it has the same diameter as the previously used one). To be sure, check calibration in

measuring mode by putting the matching precision standard with the appropriate target ball on the sensor.

- Please note that large target balls will compress soft material more than small target balls.

Please note:

If the gauge switches off during the calibration procedure due to low battery voltage, calibration must be repeated after installing fresh batteries.

Please note:

Each time the target ball is removed from the sensor tip in a distance of more than 30 mm, the gauge will automatically be adjusted to the infinite range. Any possible drift influences (e. g. through variations in temperature) will be extensively compensated. The more often the target ball is removed from the sample, the more often compensation will take place so as to increase measuring accuracy.

For that reason it is recommended to lift the target ball from the sensor tip at least every three minutes. A message will appear on display accordingly to remind you to repeat infinite setting ("Refresh infinite Value !!!).

To ensure measuring accuracy, check calibration after one hour of use of the gauge and recalibrate if necessary.

6.2 Calibration methods

According to your setting of task, you may use different calibration methods. Measuring accuracy depends on the selected calibration method. The following calibration methods are available:

- **Factory calibration.**
This calibration method is suitable for quick and simple measurement and if larger measuring errors are admissible as compared to zero calibration.
- **Zero only** (zero point calibration).
This method is for quick calibration with a medium measuring accuracy.
- **Multi -point calibration** (Zero + 1 to 4) Calibration standard(s).
In most cases a Two-point calibration (Zero + one standard) will be sufficiently good as far as calibration is made in the range of thickness to be expected. Further calibration points are recommended if measurement will be over a larger thickness range and if accuracy requirements are high.

6.3 How to calibrate

Using the sensor stand will add additional comfort during the calibration procedure. For more details please refer to section 5.3.3.

For all calibration methods the following applies:

- To call the Calibration menu from Measure mode menu, press the Calibration function key.
- Use the arrow keys to go to "Target Ball". Press OK to confirm. Use arrow keys to adjust to the requested target ball size. Press OK to confirm.
- Use arrow key to go to "Calibration Mode". Press OK to confirm and use arrow keys to make your selection. Press OK to confirm.

6.3.1 Factory Calibration

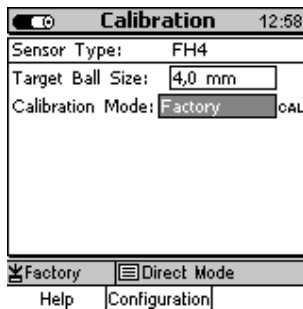

Use arrow keys to select "Factory". Press OK to confirm. The gauge is ready for measurement.

6.3.2 Zero only

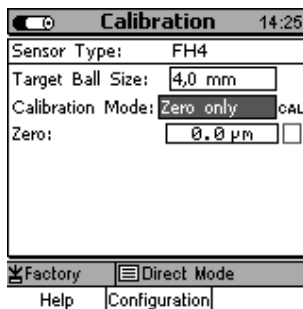

Use arrow keys to select "Zero only". Press OK to confirm.

For zero point calibration, the zero standards supplied with the gauge must be used together with the matching target balls. Make sure always first to place the target ball into the zero standard. Then put both together onto the sensor. Wait for the sound to bleep, remove the precision standard and keep it in a distance of at least 30 mm.

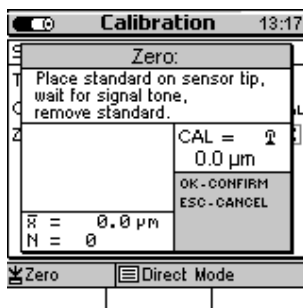

For mean calculation it is recommended to repeat the procedure several times. (To get reasonable values it is always recommended to take several readings and to have the mean calculated). Press OK to confirm.

A ticked box right to "Zero" will confirm successful calibration.

Now the gauge is ready for measurement.



Zero calibration standard with target ball put on it

6.3.3 Multi-point calibration (Zero + 1 to 4 point(s))

For multi-point calibration you must first carry out a zero point calibration. The precision standards must be used (1 to 4 as requested) to calibrate for the further calibration points. The precision standards have different thickness values.

1. In most cases a Two-point calibration (Zero + one standard) will be sufficiently good as far as calibration is made in the range of thickness to be expected.
2. Further calibration points are only necessary if measurement will be made over a larger thickness range and if accuracy requirements are high.

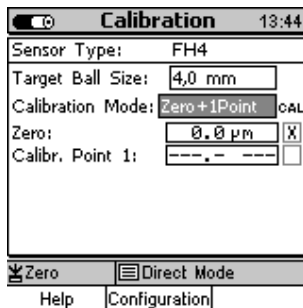

Now use arrow keys to select “Zero + 1 point” calibration. Press OK to confirm. Carry out zero calibration as described under 6.3.2. Then use arrow keys to select “Calibr. Point 1”, press OK to confirm.

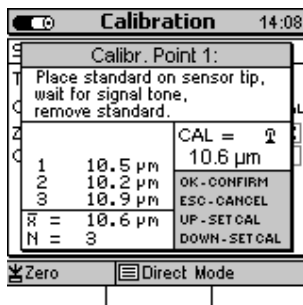

Please always use one of the precision standards supplied with the sensor. Make sure first to place the target ball on the precision standard. Then place the precision standard together with the target ball onto the sensor. Wait for the signal tone to sound and lift the precision standard more than 30 mm from the sensor. For calculation of average repeat several times.

In the “CAL = ” field, the calibration mean value will be shown which has been calculated from the set of single readings you have taken. If this value is the same as specified on the precision standard, press OK to complete the calibration procedure. If not, please use arrow keys to correct the value as requested.

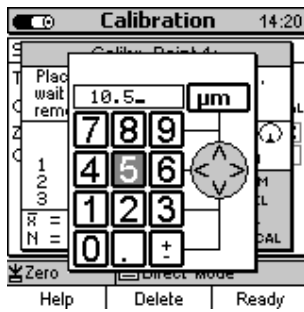

In the alphanumeric input field, you can enter the thickness of the precision standard along with the unit. ESC and OK assume navigation functions to the left or right. You can select the requested character via the numerical block. Your selection will be automatically accepted after the specified period of time. This period of time can be specified in the Setup menu. Chose User Preferences and select “Entry accepted” (see also section 10.5.5). Complete your entry by pressing Function key “**Ready**”. To store your setting, press OK. Then press OK again to quit.

For more calibration points repeat procedure as necessary. The current state of calibration is indicated in the calibration check box in the calibration menu. Ticked boxes will mark successful calibration points.

After successful calibration of the last calibration point, the gauge is ready for measurement.

6.4. Delete calibration point

Use arrow keys to move to the calibration point to be deleted.

Press “Delete” Function key and press OK to confirm or ESC to abort. Pressing “Delete” Function key a second time will remove the (X) from the check box. If you press again “Delete” Function key, the calibration value will also be deleted.

6.5 Calibration Error Sources

The following situations may lead to erratic calibration:

Error:	Remedy:
Wrong target ball:	Select an appropriate target ball suitable for your measuring sample and the thickness to be expected. Adjust to the correct target ball size via the menu.
Calibration range does not match to the thickness to be expected:	Calibrate within the thickness range to be expected.
During calibration, the precision standard has not been placed correctly on the sensor Tip.	Make sure to fully engage the precision standard on the sensor tip.
Calibration error due to changes in temperature	Before calibration, the sensor must be adapted to the ambient temperature. Please wait 30 minutes after switch on before starting measurement.
Worn or damaged precision standards:	Please use new precision standards in impeccable condition.
Build-up on the sensor tip.	Clean sensor tip from metal parts, dirt particles etc. by using a soft cloth.

7. Data Storage

7.1 Batches

7.1.1 General

Readings and their statistics will be stored in batches. Batches can be named alphanumerically and stored in the database directly or under a certain directory. One batch is firmly installed under the name "Direct Mode". This batch cannot be deleted nor can it be renamed.

The model MiniTest 7200 FH does **not** include the database feature, but it offers one predefined measuring batch.

7.1.2 Batch Data

7.1.2.1 Readings

One batch may include as many as 100,000 single readings plus statistics. The model MiniTest 7400 FH offers a maximum of 240,000 values in total.

7.1.2.2 Calibration Values

Calibration always refers to a certain measuring batch. As soon as a measuring batch is called, the corresponding calibration will become active. The calibration includes the following parameter settings: diameter of target ball, type of calibration and sensor.

7.1.2.3 Other Parameters

The parameters as set in the Configuration submenu such as Data logging mode, Logging rate, Graphics (ON/OFF), Upper spec. limit, Lower spec. limit, and Setpoint refer to a certain batch and will become valid as soon as this batch is called.

7.2 Database of the MiniTest 7400 FH

7.2.1 General Remarks

The database includes numerous features for data management. Measuring batches can be stored in directories and subdirectories. In total, as many as 500 directories may be created in a maximum of 5 levels. Directories and batches can be named alphanumerically.

7.2.2 Tree structure

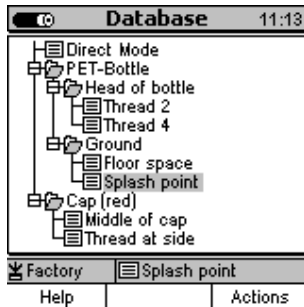

Example for a tree-structured database divided in directories and batches. At first use of the MiniTest 7400 FH, the database only includes one batch named “Direct Mode”. You can create other directories or batches as required.

Note: For creating new directories or batches, make sure to place the cursor below this Direct Mode directory.

7.2.3 Create a Directory



Press function key “Main Menu”. Then select “Database” and press OK to confirm.

Use arrow down key of the navigation block to place the cursor below “Direct mode” or, if other directories have already been created, to the requested position where a new directory should be created.

This may be below or between directories or batches. Now press function key “Actions” and press OK to confirm “New Directory” which is highlighted.



Enter a name in the alphanumerical input field. For more details, please refer to section 4.4.3 “Alphanumerical Entries”.

7.2.4 Create a New Batch



From **Measure Menu** press function key “Main Menu”. Then select “Database” and press OK. Use arrow down key of the navigation block to place the cursor below “Direct mode” or, if other directories have already been created, to the requested position where a new directory should be created. This may be below or between directories or batches. Now press function key “Actions” and move cursor to “New Batch” which is highlighted. Press OK to confirm. Enter a name in the alphanumerical input field. For more details, please refer to section 4.4.3 “Alphanumerical Entries”.

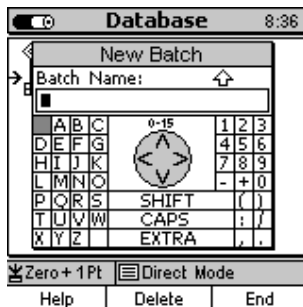

After you have entered the batch name, the alphanumerical screen appears. Now you can enter a user name below the batch name according to the procedure as described above.



After completion of user name input, the confirmation as shown on the left appears. If you wish to accept the parameters (calibration and configuration) as set for the active batch for the new batch to be created press OK. If you press ESC, preset parameters of the factory calibration will become valid. Parameter settings can be made in the “Configuration” submenu. Please refer to section 10.4.3 for more details.

7.2.5 Select a Batch for Measurement

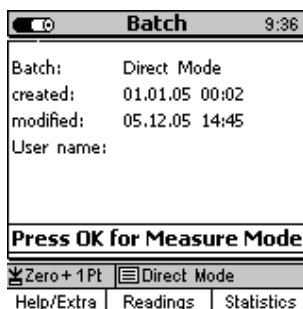

From **Main Menu** select “Database”. Use arrow keys to select the requested batch. Press OK to confirm. The data stored under this batch appear on display. Press OK to switch to **Measure Menu**.

7.2.6 Delete a Batch / a Directory



From **Measure Menu** press function key “Main Menu“ and select „Database“. Press OK to confirm.

Use arrow keys to select the directory or batch to be deleted. Press function key “Actions“. Select “Delete” from the “Actions” submenu. A confirmation appears. Press OK to confirm or ESC to abort.

If you have chosen a directory, the delete action will only delete empty directories. If the directory includes subdirectories and batches, these must be deleted previously.

Please note: The batch “Direct Mode” is a permanent part of the database. It can neither be deleted nor renamed. Nor you can assign a username to it. However, you can delete readings or statistical values.



Once you have deleted data they cannot be restored.

7.2.7 Rename a Batch / Rename a Directory



From **Measure Menu** press function key “Main Menu“ and select “Database“. Press OK to confirm.

Use arrow keys to select the directory or batch to be renamed. Your selection will be highlighted. Press function key “Actions“.

Use arrow keys to go to “Rename“. Press OK to confirm.

On the alphanumeric input field the name to be changed appears. This name can be changed (see section 4.4.3 “Alphanumerical Entries“.) This action will not change the username.

8. Statistics

From **Measure Menu** press function key “Statistics“.

From **Main Menu** use arrow keys to select “Statistics” and press OK to confirm.

8.1 Statistical Parameters

8.1.1 Upper and lower specifications limits (USL and LSL)

Tolerance limits can be set as requested and offer you the following features:

- Readings beyond the specification limits will be indicated by a signal tone and marked in the statistics.
- The process capability indices Cp and Cpk will be calculated according to the set specification limits.
- In the trend diagram and histogram, readings lying within the set specification limits will be highlighted. This range will determine the real-time trend (only available with MiniTest 7400 FH).

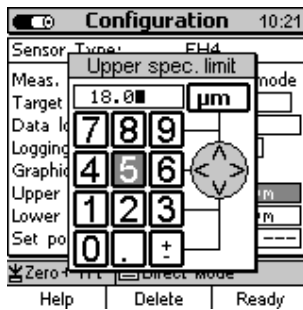

The specification limits can be set in the “Configuration” submenu. . Use arrow keys to go to “Upper spec. limit” and/or “Lower spec. limit”

Specify limits and measuring system (metric/imperial) as requested via the alphanumerical input field. See also section 4.4.2 “Alphanumerical Entries”.

Complete your setting by pressing Function key “Ready”. The gauge will check automatically whether your spec. limits are reasonable. This is to prevent input errors such as entering a wrong measuring unit. Press OK to confirm your changes.

Spec. limits can be deleted via the function key “Delete”.

Spec. limits can be set before or after readings have been taken.

8.1.2 Set Point (Differential Mode)

In quality control, it may be interesting to measure the difference between a set point and the actual thickness. Once you have specified a set point, the difference between this set point and the actual thickness will be displayed. A set point must be entered BEFORE storing the first reading. If you change a preset set point, the stored readings must be deleted previously.

The set point can be set in the "Configuration" submenu. Use arrow keys to go to "Set point" and enter a value as requested along with the correct measuring system (metric/imperial) via the alphanumerical input field. See also section 4.4.2 "Alphanumerical Entries".

Complete your setting by pressing Function key "Ready". Set point settings can be deleted via the function key "Delete".

8.2 Readings

8.2.1 View Readings

From **Main Menu** go to "Statistics". Press OK and select "Readings" submenu.

From **Measure Menu** press function key "Statistics". Then press function key "Batch" followed by function key "Readings".

Use arrow keys to scroll through the batch as requested. Readings will be indicated along with their current reference number. If spec. limits have been set previously, information is included whether the readings have been above (>>) or below (<<) the spec. limit.

8.2.2 Delete Single Readings

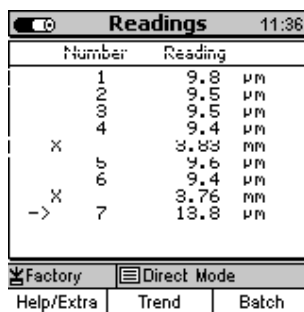

Readings 11:36		
Number	Reading	
1	9.8	µm
2	9.5	µm
3	9.5	µm
4	9.4	µm
X	8.83	mm
	9.6	µm
	9.4	µm
X	8.76	mm
->	7	13.8 µm

Factory Direct Mode
Help/Extra | Trend | Batch

Erratic readings may be deleted from the list.

Move the cursor to the reading to be deleted.

Press function key "Help/Extra". Move cursor to "Delete Readings" and press OK to confirm or press ESC to abort.

Readings that have been deleted are marked by (X).

8.2.3 Delete all Readings

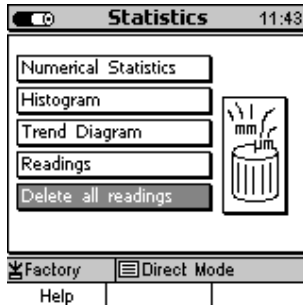

From **Main Menu** chose "Statistics". Use arrow keys to move to "Delete all readings". Press OK to confirm.

From **Measure Menu** press function key "Statistics" followed by function key "Help/Extras". Use arrow keys to move to "Delete all readings". Press OK to confirm.

To abort, press ESC.

The delete action will delete all readings of the active batch. Batch name, sensor configuration and calibration for this batch will remain in memory.

8.3 Numerical Statistics

From **Main Menu** chose "Statistics". Use arrow keys to move to "Numerical Statistics". Press OK to confirm.

From **Measure Menu** press function key "Statistics".

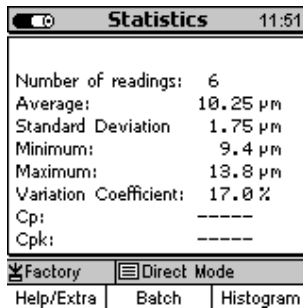

Number of readings

Average (\bar{x})

Standard deviation (s)

Minimum

Maximum

Variation coefficient

Process capability indices Cp and Cpk (if spec. limits have been set).

For more detailed information on statistics please refer to section 15.3.

8.4 Histogram on MiniTest 7400 FH

From **Main Menu** chose “Statistics“. Use arrow keys to move to “Histogram“. Press OK to confirm.

From **Measure Menu** press function key “Statistics” followed by function key “Histogram”.

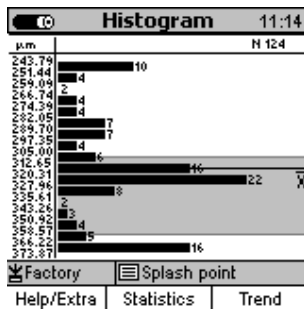

A histogram is a kind of plot that summarizes how data are distributed. It gives you information on how the production process might be changed in order to be optimized.

The limit range is the gray-highlighted area. See also 8.1.1 “Upper and lower spec. limits”.

Please note: For a histogram, a minimum number of 5 readings are required.

8.5 Trend Diagram on MiniTest 7400 FH

From **Main Menu** chose “Statistics“. Use arrow keys to move to “Trend Diagram“. Press OK to confirm.

From **Measure Menu** press function key “Statistics” followed by function key “Histogram”. Then press function key “Trend”.

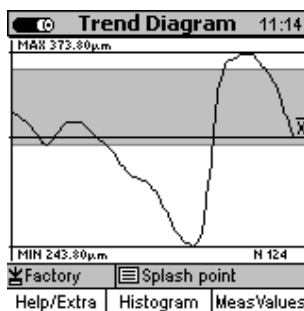

A trend illustrates the tendency of readings so that deviations can be quickly identified.

The limit range is the gray-highlighted-area.

For a trend-diagram, at least 5 readings are required.

9. Data Output / Data Transfer

Both models, MiniTest 7200 FH and MiniTest 7400 FH are equipped with a bi-directional RS232 interface and an infrared interface (IrDA 1.9). Readings and statistics of a batch can be transferred to a PC or to the MiniPrint 7000 data printer (available as an option).

9.1 Data Print-Out

Data transfer of readings and statistics to the data printer MiniPrint 7000 is made via the infrared interface (IrDA 1.0). Before printing out, go to the Main Menu and select "Setup". Use arrow keys to move to "Data Output" and press OK to confirm. Use arrow keys to select "Infrared (IrDA)". For more details, please refer to section 10.5.4.2.

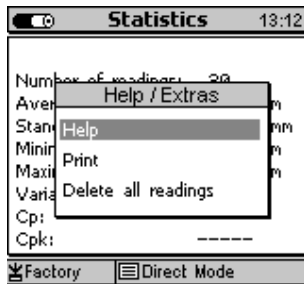

Fig. 1

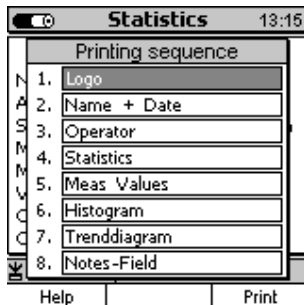

Fig. 2

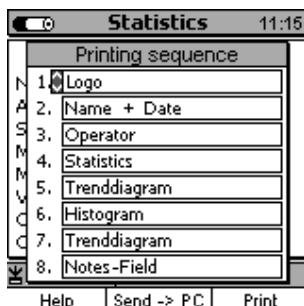

Fig. 3

Readings and statistics may be printed out from all statistical views such as statistics, batch, histogram or trend (MiniTest 7400 FH). Press "Help/Extra" Function key from your selected statistical view. The Help/Extra window opens (Fig. 1)

Select "Print" from the list and confirm by "OK".

A "Printing sequence" menu opens (Fig. 2) Move the cursor to the first item on the list and press OK. Use arrow keys to make your selection (Fig. 3). The following options are available:

- Logo (Company logo or other customized logo in graphics format (160x80 Pixel). For inserting such logo, MSoft 7000 software is required.
- Name (of batch) / or name (of batch) + date (MiniTest 7400 FH).
- Operator (with MiniTest 7200 FH Notes-Field only)
- Statistics (number of readings, Average (\bar{x}) Standard deviation (s), Min., Max. Variation Coefficient, Cp and Cpk).
- Measuring Values or Measuring Values + Deleted Values (see also section 8.2.2).
- Trend (MiniTest 7400 FH only)
- Histogram (MiniTest 7400 FH only)
- Notes-Field (space for remarks with 5 lines)
- ----- (remains empty)

Press OK to confirm your selection and go to the next position on the printing list and proceed as described above.

The print-out list can also be limited to fewer items (e.g. statistics and measuring values only, Fig. 4)

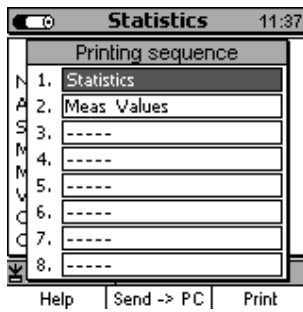

Fig. 4

Now align the infrared windows of the MiniTest and MiniPrint 7000.

Press function key "Print" to start the print-out.

To abort, press "ESC".

9.1.1 Screen Shot

Please refer to section 11.2 "Special functions".

9.1.2 Print-out a Batch

Please refer to section 9.1 "Data Print-out"

9.2 Transfer Data to a PC

Before transferring data, go to the **Main Menu** and select “Setup”. Use arrow keys to move to “Data Output” and press OK to confirm. Use arrow keys to select “RS232 cable” or “Infrared (IrDA)”. Press OK to confirm. See also section 10.5.4. If you adjust to RS232, please make sure to make the correct settings for baud rate and transmission protocol.

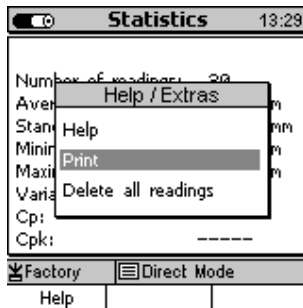

Readings and statistics may be transferred to a PC from all statistical views such as statistics, batch, histogram or trend (MiniTest 7400 FH). Press “Help/Extra” Function key from your selected statistical view. The Help/Extra window opens (Fig. 1)

Select “Print” from the list and confirm by “OK”.

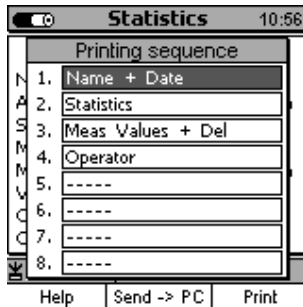

A “Printing sequence” menu opens. Move the cursor to the first item on the list and press OK. The following options are available:

- Name (of batch) / or name (of batch) + date (MiniTest 7400 FH).
- Statistics (number of readings, Average (\bar{x}) Standard deviation (s), Min., Max. Variation Coefficient, Cp and Cpk).
- Measuring Values or Measuring Values + Deleted Values (see also section 8.2.2).
- Operator (with MiniTest 7200 FH Notes-Field only)
- ----- (remains empty)

Press OK to confirm you selection.

Connect the MiniTest FH via the RS232 cable to your computer or align the infrared windows of your computer or of your IrDA adapter respectively.

Then press Function key “Send->PC”.

To abort, press “ESC”.

Please note: The “MSoft 7000 Pro” software recalculates the histogram and trend diagram (MiniTest 7400 FH only) and optimizes their display in graphical format.

10. Main Menu

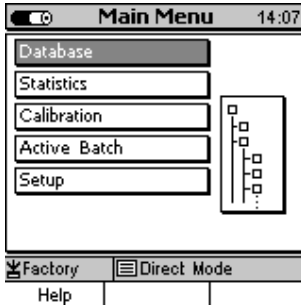

10.1 Database

Please refer to section 7.2.

10.2 Statistics

Please refer to section 8.

10.3 Calibration

Please refer to section 6.

10.4 Active Batch



From Main Menu chose “**Active Batch**” and press OK to confirm.
Now you can select from the options as shown on the left.

10.4.1 Batch Properties

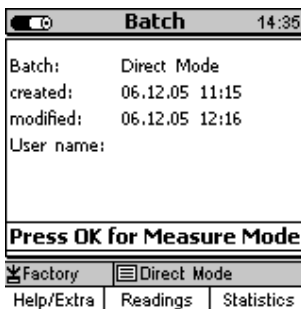

Select “Batch properties” and press OK to confirm.

Now you can view:

Batch name (with MiniTest 7400 FH)

Create date,

Modified date

User name.

Press function key “Statistics” to view the statistics of this batch..

10.4.2 Readings

Number	Reading
21	7.9 µm
22	7.7 µm
23	7.7 µm
24	7.7 µm
25	7.7 µm
26	3.12 µm
26	8.2 µm
27	7.7 µm
28	7.7 µm
29	7.6 µm
->	30 7.6 µm

Factory Direct Mode
Help/Extra Trend Batch

This menu is for viewing readings.

To view the corresponding statistics, press function key “Batch” followed by function key “Statistics”. See also section 8.

10.4.3 Configuration

Sensor Type:	FH4
Meas. Mode:	Contin. mode
Target Ball Size:	4,0 mm
Data logging mode:	Auto
Logging rate:	1 / sec
Graphics:	OFF
Upper spec. limit	---, - ---
Lower spec. limit	---, - ---
Set point:	---, - ---

Factory Direct Mode
Help Calibration

In this menu you can set the following parameters to define your batch as requested:

- Target ball size (see section 5.2.2)
- Data logging mode (see section 5.5)
- Logging rate (see 5.5)
- Graphics on/off (see section 4.3.2)
- Upper spec. limit (see section 8.1.1)
- Lower spec. limit (see section 8.1.1)
- Set point (see section 8.1.2)

10.4.4 Calibration

Sensor Type:	FH4
Target Ball Size:	4,0 mm
Calibration Mode:	Factory CAL

Factory Direct Mode
Help Configuration

Please refer to section 6.

10.5 Setup

10.5.1 General Remarks

In this menu both models, MiniTest 7200 FH and 7400 FH can be adjusted to customer requirements.

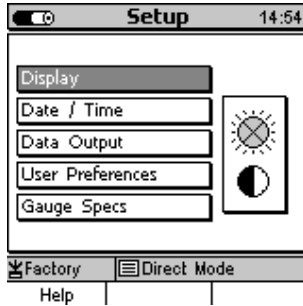

From **Measure Menu** press function key “Main Menu”. Use arrow key to select “Setup”. Press OK to confirm.

Use arrow keys to go to the requested item and press OK to confirm.

10.5.2 Display

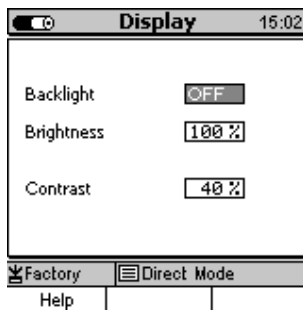

In this menu you can adjust the backlight of display and keys (on/off); brightness and contrast). Please refer to section 4.4.1 for more details.

10.5.3 Date and Time



In this menu you can adjust date and time, day, month and year. Please refer to section 4.4.1 for more details.

The gauge features a quartz-controlled time clock. The current time is displayed on the top right of display. If connected to the data printer or for PC evaluation, the create date and time and date and time of last modification may be included on the batch report.

10.5.4 Data Outputs

In the “Data Output” menu you can choose RS232 cable or Infrared (IrDa). Please refer to section 4.4.1 for more details.

10.5.4.1 Data Output RS232 Cable

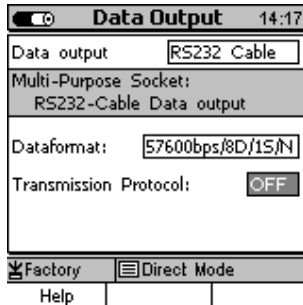

If “RS232 Cable” has been selected, you can adjust the data format to the requested baud rate:

57600 (default), 38400, 19200, 9600

The settings 8 data bits, 1 Stop-Bit, No Parity do not change.

The Transmission Protocol option must be “off” when using the Msoft 7000 Basic. (Description of transmission protocol available on request).

If you have adjusted to “RS232 Cable“, you cannot connect a footswitch, charger unit or alarm device to the multi-purpose socket.

10.5.4.2 Data Output Infrared (IrDA)

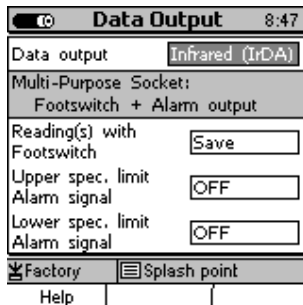

If you have adjusted to “Infrared (IrDA)”, data transmission to the MiniPrint 7000 data printer or to a PC will be wireless.

In this setting, you can connect a footswitch, power supply unit or alarm device to the multipurpose socket. If a footswitch has been connected, a power unit and an alarm device may be connected to the footswitch.

Via the footswitch you can “Save” readings to the statistics or “delete” Minimum and Maximum values during measurement.

The duration of the alarm signal can be adjusted individually so that you are able to distinguish the alarm signals for exceeding upper specification limit and lower specification limit. The duration can be adjusted to 50, 100, 150, 200, 250, 300, 350, 400 ms or to

permanent signal.

10.5.5 User Preferences



In the User Preferences menu the following settings can be made:

- Language
- Measuring system (metric / imperial)
- Loudspeaker (ON/OFF).
- Signal Volume (low, high, medium)
- Auto Switch OFF (after 1, 3, 10, 30 minutes, disabled)
- Entry accepted (numeric or alphanumeric entries accepted (after 0,5, 1, 1,5 or 2 seconds).
- Modification lock**

** You can assign a password for the Modification lock (pay attention to upper and lower case so that the modification lock will be password protected. If you have forgotten the password you can make a total reset. Please note: a total reset deletes all readings and settings stored in memory. Please also refer to section 4.4.1.

10.5.6 Gauge Specifications

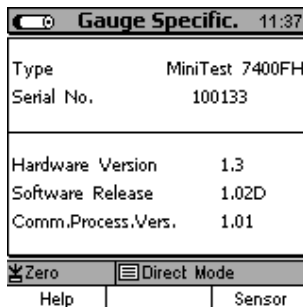

From Setup Menu use arrow keys to go to "Gauge Specs". Press OK to confirm. Now you can view gauge specifications.

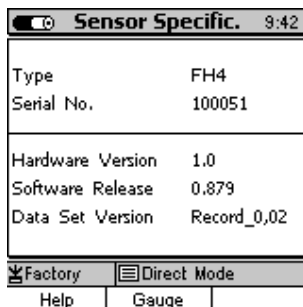

For viewing sensor data press function key "Sensor".

In case of service requests please make available these data for further reference.

11. Special functions

11.1 Initializing

At first use or on demand the initializing sequence may be called.

Press ON/OFF button and ESC simultaneously to go to the initializing sequence.

A language flag symbol appears.

Use arrow keys to make your selection. Press OK to confirm or ESC to abort.

Now a Total Reset query appears. Press “No” if you do not wish to perform a Total Reset to delete all data.



Attention!

Pressing “Yes“ will irrevocably delete all data and settings stored in memory. However, your language setting remains and the gauge will be reset to factory setting.

All directories and batches will be deleted along with their readings, statistics and calibration values.

Press ESC to abort the Total Reset process. Only the language settings remain in memory.

11.2 Special functions

Press ON/OFF button for more than one second while the gauge is switched on. Now a **Special functions** menu appears with the following setting options:

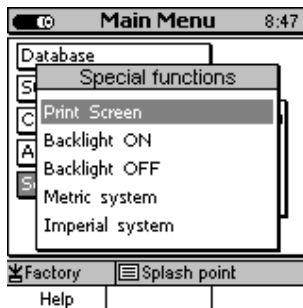

- Print Screen (print-out of screenshot on MiniPrint 7000 data printer)
- Backlight (of display and keyboard) ON
- Backlight (of display and keyboard) OFF
- Metric system
- Imperial system

All these setting options except the Print Screen item may also be accessed via the menu system. The **Special functions** menu is meant for quick access to these functions at any time during operation. To quit the Special functions menu and to go back to your current operation, press OK to confirm your setting or ESC.

12. Quick Reference

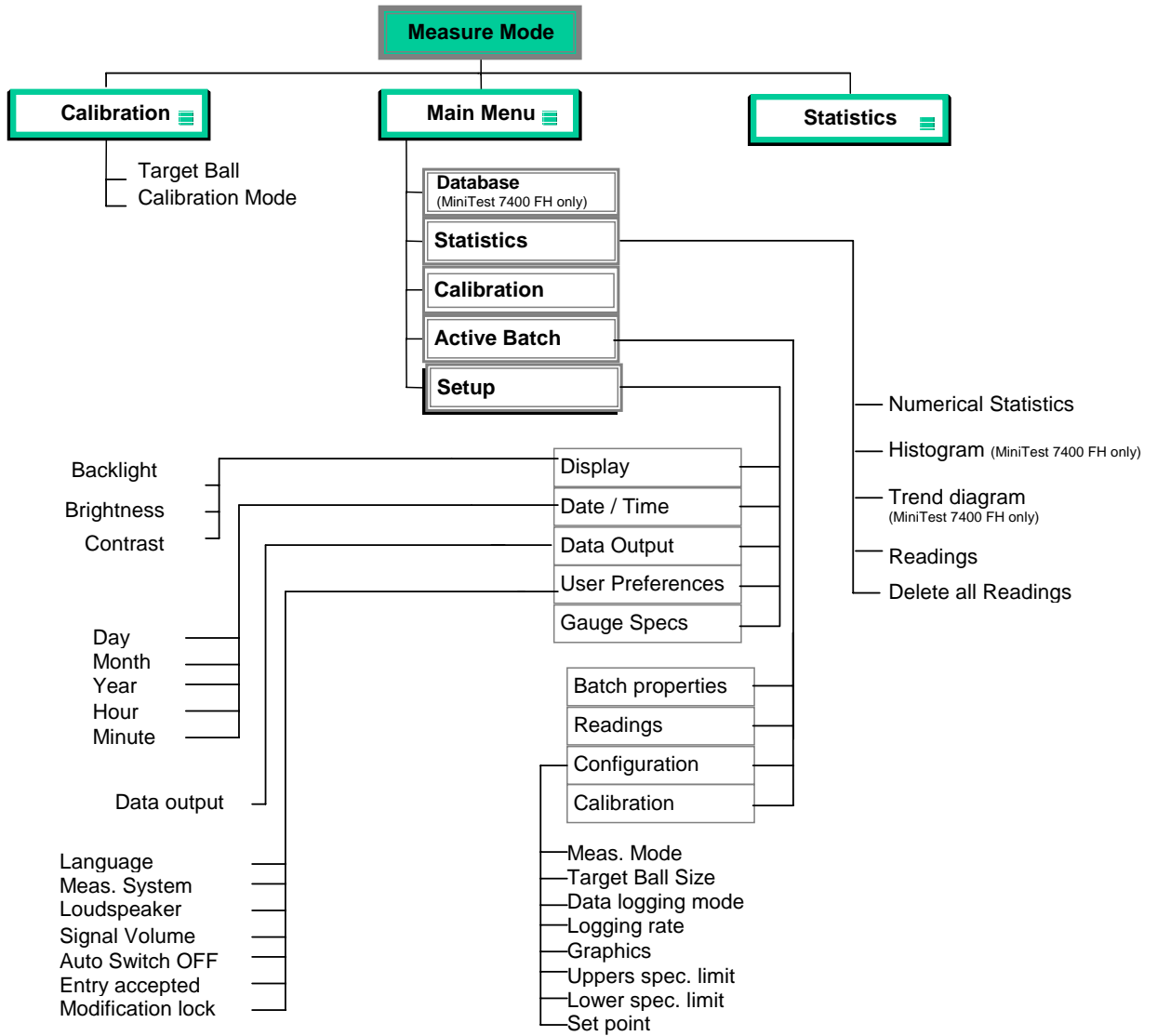

13. Care and Maintenance

13.1 Care

Use a soft damp cloth with water or a mild detergent to clean the gauge and accessories.

Caution:

Do not use solvents because they might damage the plastic parts. Do not use metal brushes or other tools for cleaning the sensor tip.

13.1.1 Using NiMH storage batteries

To achieve optimal service life of the NiMH storage batteries, please respect the following instructions.

- Make sure to use the full battery capacity before your recharge it. Frequent short discharge and recharge cycles prematurely reduce their service life.
- The storage batteries should always be fully recharged. Avoid premature interrupt of reload process, otherwise batteries may not be recharged to their full capacity any more.
- Try to save battery life e. g. by operating the MiniTest 7200 FH / 7400 FH in Auto Switch off mode, instead of continuous service.

13.2 Maintenance

Generally, no maintenance work is required for MiniTest 7200 FH / 7400 FH.

Please note: Repairs may only be carried out by authorized ElektroPhysik staff.

14. Technical specification

14.1 Gauge and Sensor Specification

Measuring principle:		magneto-static principle, suitable for nonmagnetic materials			
Measuring rate:		20 readings per second (factory set)			
Number of readings to be logged for statistics:		1, 2, 5, 10 or 20 readings per second (user adjustable)			
Sensor types:		FH4		FH10	
Low range resolution:		0.1 μm		0.2 μm	
Display resolution		Ranges		Resolution:	
		0.0 μm – 59.9 μm 60.0 μm – 149.9 μm 150.0 μm – 299.5 μm 300.0 μm – 599.0 μm 600.0 μm – 998.0 μm 1.000 mm – 1.498 mm 1.500 mm – 2.995 mm 3.00 mm – 5.99 mm 6.00 mm – 10.12 mm		0.1 μm 0.2 μm 0.5 μm 1 μm 2 μm 2 μm 5 μm 10 μm 20 μm	
FH4 Sensor					
Target ball \varnothing	Measuring range	Reproducibility	Tolerance:		
			Factory calibration:	Zero-point calibration	Multi-point calibration
1.5 mm	0 ... 1.5 mm	$\pm (1.5 \mu\text{m} + 0.5\%)*$	$\pm (10 \mu\text{m} + 3\%)*$	$\pm (5 \mu\text{m} + 1.5\%)*$	$\pm (3 \mu\text{m} + 1\%)*$
2.5 mm	0 ... 2.5 mm	$\pm (2.5 \mu\text{m} + 0.5\%)*$	$\pm (15 \mu\text{m} + 3\%)*$	$\pm (8 \mu\text{m} + 1.5\%)*$	$\pm (5 \mu\text{m} + 1\%)*$
4.0 mm	0 ... 4.0 mm	$\pm (5 \mu\text{m} + 0.5\%)*$	$\pm (30 \mu\text{m} + 3\%)*$	$\pm (15 \mu\text{m} + 1.5\%)*$	$\pm (10 \mu\text{m} + 1\%)*$
FH10 Sensor					
Target ball \varnothing	Measuring range	Reproducibility	Tolerance:		
			Factory calibration:	Zero-point calibration	Multi-point calibration
2.5 mm	0 ... 2.5 mm	$\pm (2.5 \mu\text{m} + 0.5\%)*$	$\pm (15 \mu\text{m} + 3\%)*$	$\pm (8 \mu\text{m} + 1.5\%)*$	$\pm (5 \mu\text{m} + 1\%)*$
4.0 mm	0 ... 4.0 mm	$\pm (5 \mu\text{m} + 0.5\%)*$	$\pm (30 \mu\text{m} + 3\%)*$	$\pm (15 \mu\text{m} + 1.5\%)*$	$\pm (10 \mu\text{m} + 1\%)*$
6.0 mm	0 ... 6 mm	$\pm (10 \mu\text{m} + 0.5\%)*$	$\pm (50 \mu\text{m} + 3\%)*$	$\pm (30 \mu\text{m} + 1.5\%)*$	$\pm (20 \mu\text{m} + 1\%)*$
	6 ... 10 mm	$\pm 0.5\%*$	$\pm 4\%*$	$\pm 2.5\%*$	$\pm 1.5\%*$
9.0 mm	0 ... 10 mm	$\pm (10 \mu\text{m} + 0.5\%)*$	$\pm (50 \mu\text{m} + 3\%)*$	$\pm (30 \mu\text{m} + 1.5\%)*$	$\pm (20 \mu\text{m} + 1\%)*$
<ul style="list-style-type: none"> All percentages are related to the measuring value Measurement on horizontal surfaces, mean value calculated from a minimum of 10 readings					

Calibration modes:	Factory calibration, Zero point calibration and multi-point calibration ((Zero plus 1 to 4 calibration points)	
Display:	LCD 160 x 160 pixel, backlit (user adjustable)	
Measuring system:	metric (μm , mm) and imperial (mils)	
Statistics functions:	Single readings, number of readings, min, max, average, standard deviation, variation coefficient and process capability indices Cp and Cpk (only available with MiniTest 7400 FH)	
Data memory:	7200 FH	7400 FH
Maximum number of directories:	0	500 subdivided into 5 levels
Maximum number of batches:	1	200
Maximum number of readings:	100.000	240.000
Differential mode:	Display of the difference between current reading and preset set point	
Statistics:	7200 FH: numerical	7400 FH: numerical, histogram, trend diagram
Languages:	English, German, French, Italian, Spanish, Portuguese	
Interfaces:	IrDA, 1.0, Multi-purpose socket for RS232 TTL, footswitch, power supply unit and alarm device	
Operating temperature:	-10°C to + 60°C	
Storing temperature:	-20°C to + 80°C	
Protection class of gauge housing:	IP 50	
Dimensions and weight of gauge:	153 mm x 89 mm x 32 mm / 310 g including batteries	
Dimensions and weight of FH 4 sensor	\varnothing 17 mm x 96 mm / 90 g	
Dimensions and weight of FH 10 sensor:	\varnothing 30 mm x 125 mm / 300 g	
Dimensions of plastics carrying case:	365 mm x 450 mm x 140 mm	
Power supply:	4 x 1,5 V LR 6 – AA baby cells, Power supply unit (90 to 240V AC / 48 - 62 Hz)	

14.2 Delivery Schedule

14.2.1 Thickness gauge MiniTest 7200 FH / 7400 FH

Description	Order number
Thickness gauge MiniTest 7400 FH for non-magnetic materials	80-176-0000
or	
Thickness gauge MiniTest 7200 FH for non-magnetic materials	80-177-0000
including: Instruction manual in German/English/French on CD-Rom Short instructions 4 x batteries AA (LR06), Plastics carrying case, rubber protection case with positioning device and shoulder belt, 1 magnetic screwdriver	

14.2.2 Sensors

Description	Order number
Sensor FH4 for thickness measurement measuring range: 0 ... 4.0 mm including: shielding tube 3 precision standards 0.25 mm, 1 mm, 3 mm 1 zero calibration standard for the target balls with 1.5 mm, 2.5 mm, 4 mm dia. (1 zero calibration standard per size) 1 spring loaded sensor stand 1 set of target balls with 1.5 mm and 2,5 mm dia.(100 balls each size) 1 set of target balls with 4 mm dia (50 balls)	80-174-0000
Sensor FH 10 for thickness measurement measuring range: 1...10.0 mm including shielding tube 3 precision standards 1 mm, 3 mm, 8 mm set of zero calibration standards for the target balls with 2.5mm, 4mm and 6mm dia. (1 pc each ball size) 1 spring-loaded sensor stand 1 set of target balls with 2.5 mm dia. (100 balls) 1 set of target balls with 4 mm dia (50 balls) 1 set of target balls with 6 mm dia (25 balls)	80-175-0000

14.3 Accessories

Description	Order number
Data printer MiniPrint 7000 incl. charger unit	80-202-0000
Quick charger for NiMH storage batteries	02-070-0001
NiMH storage baby cells, AA HR6 1,2V (4 pcs required for MiniTest FH)	02-064-0001
Baby cells AA LR6 1,5V (4 pcs required for MiniTest)	02-064-0008
Power supply unit	80-900-0004
Footswitch for storing readings into the data memory, incl. adapter unit for mains operation	80-901-1800
Rubber protection case with positioning device (included in standard supply schedule)	82-010-0003
Belt for rubber protection case	82-010-0016
Case with shoulder belt for MiniTest 7200 FH / 7400 FH	82-010-0007
Plastics carrying case (incl. in standard supply schedule)	82-020-0033
Dust protection pouch	85-199-0001
IR / USB converter	85-139-0014
IR/RS232 converter	85-139-0013
Connecting box for footswitch, USB, power unit, alarm deice, headphones	
MSoft 7000 basic data transmission software	80-901-1600
MSoft 7000 pro data management software	80-901-xxxx
Manufacturer's Test Certificate according to DIN 55350 M for gauges and sensors	
Accessories for sensor FH4	
Sensor stand, spring-loaded, for s Sensor FH4 (incl. in standard delivery)	70-174-0015
Zero calibration standard for FH4 sensor 1. 5 mm dia. target ball (stand. delivery)	82-174-0024
Zero calibration standard for FH4 sensor 2. 5 mm dia. target ball (stand. delivery)	82-174-0025
Zero calibration standard for FH4 sensor 4 mm dia. target ball (stand. delivery)	82-174-0026
Precision standard for sensor FH4 0.3 mm (standard delivery)	82-174-0020
Precision standard for sensor FH4 1 mm (standard delivery)	82-174-0021
Precision standard for sensor FH4 3 mm (standard delivery)	82-174-0023

1 set precision standards for sensor FH 4 for multi-point calibration for 1.5 mm dia. target ball size, comprising: 1 precision standard set for approx. 0.15 mm, 0.25 mm, 0.43 mm, 0.75 mm and 1.3 mm	82-174-0010
1 set precision standards for sensor FH4 for multi-point calibration for 2.5 mm target ball size, comprising: 1 precision standard set for approx. 0.25 mm, 0.43 mm, 0.75 mm, 1.3 mm and 2.2mm (1 pc each)	82-174-0011
1 set precision standards for sensor FH4 for multi-point calibration for 4,0 mm target ball size, comprising: 1 precision standard set for approx. 0.43 mm, 0.75 mm, 1.3 mm, 2.2 mm and 3.6mm (1 pc each)	82-174-0012
1 set of target balls, 1.5 mm dia. (100 pcs)	82-174-0004
1 set of target balls, 2.5 mm dia. (100 pcs)	82-175-0004
1 set of target balls, 4 mm dia. (50 pcs)	82-175-0005
Manufacturer's Test Certificate according to DIN 55350 M for precision standards	
Manufacturer's Test Certificate according to DIN 55350 M for 1 set precision standards for multi-point calibration	
<u>Accessories for sensor FH10</u>	
Sensor stand, spring-loaded, for s Sensor FH 10 (incl. in standard delivery)	70-175-0014
Zero calibration standard for FH 10 sensor 2. 5 mm dia. target ball (standard delivery)	82-175-0033
Zero calibration standard for FH 10 sensor 4 mm dia. target ball (standard delivery)	82-175-0034
Zero calibration standard for FH 10 sensor 6 mm dia. target ball (standard delivery)	82-175-0035
Zero calibration standard for FH 10 sensor 9 mm dia. target ball (standard delivery)	82-175--0036
Precision standard for sensor FH10 1 mm (standard delivery)	82-175-0030
Precision standard for sensor FH10 3 mm (standard delivery)	82-175-0031
Precision standard for sensor FH10 8 mm (standard delivery)	82-175-0032
1 basic calibration set for sensor FH10 for target ball dia. 9.0 mm, comprising: Zero calibration standard, and 10 pcs target balls 9 mm dia., comes in a plastics box	82-175-0038
1 set precision standards for sensor FH10 for multi-point calibration for target ball dia. 2.5 mm, comprising: 1 set precision standards approx. 0.25 mm, 0.43 mm, 0.75 mm, 1.3 mm and 2.2mm	82-175-0020

1 set precision standards for sensor FH10 for multi-point calibration for target ball dia. 4.0 mm, comprising: 1 set precision standards approx 0.43 mm, 0.75 mm, 1.3 mm, 2.2 mm and 3.6 mm	82-175-0017
1 set precision standards for sensor FH10 for multi-point calibration for target ball dia. 6.0 mm, comprising: 1 set precision standards approx 1.0 mm, 1.7 mm, 3.0 mm, 5.2 mm and 9.0 mm	82-175-0010
1 set precision standards for sensor FH10 for multi-point calibration for target ball dia. 9.0 mm, comprising: 1 set precision standards approx 1.0 mm, 1.7 mm, 3.0 mm, 5.2 mm and 9.0 mm	82-175-0037
1 set of target balls, 2.5 mm target ball size (100 pcs)	82-174-0004
1 set of target balls, 4 mm target ball size (50 pcs)	82-175-0005
1 set of target balls, 6 mm target ball size (25 pcs)	82-175-0006
1 set of target balls, 9 mm target ball size (10 pcs)	82-175-0014
Manufacturer's Test Certificate according to DIN 55350 M for precision standards	
Manufacturer's Test Certificate according to DIN 55350 M for 1 set precision standards for multi-point calibration	

15. Appendix

15.1 Troubleshooting

Error message	Problem	Remedy
"Please check clock settings"	If you insert batteries at initial use or if the gauge has been cut from power supply for more than 5 minutes	Reset clock (s. section 10.5.3)
"Low Bat !!!"	Though you can continue to measure, it is recommended to change batteries. If battery voltage is below minimum, the gauge will switch off automatically.	Change batteries. Dispose batteries according to your local regulations.
"Please hold probe in air(infinite range) !! " (Briefly appears on display at switch on)	Please check a) whether you have removed the shielding tube or protection cap b) whether a target ball is positioned on the sensor tip c) whether the sensor tip is in contact with a steel part See also section 6.1	a) Remove shielding tube or protection cap b) Remove target ball from sensor tip c) Enlarge distance between sensor head and steel part Now the message on display should disappear and the sensor is ready for measurement.
"Confirm sensor in infinite range"	a) a target ball is placed on the sensor tip or the sensor is near an ferritic object or magnetic field. b) Infinite adjustment required. See also section 6.1	The message does not disappear, and the following message appears after about 10 sec: "Make sure there is no target ball near the sensor. Please keep the sensor away from metallic objects or magnetic fields." If this message persists, press

		<p>Function key "Infinite".</p> <p>Now the message should disappear and the gauge is ready for measurement.</p> <p>Attention:</p> <p>Make sure not to press the Infinite function key unless you have removed the error sources (target ball, magnetic field or metallic parts).</p>
<p>"Refresh infinite value !!!"</p> <p>(The infinite value should be actualized)</p>	<p>To ensure the guaranteed measuring accuracy, the infinite value must be refreshed.</p> <p>See also section 6.1</p>	<p>Remove target ball from sensor.</p> <p>If the message persists, please press Refresh function key.</p> <p>During a measurement you can press ESC in order to cancel the Refresh procedure.</p>
<p>"Sensor type not compatible with batch !"</p> <p>"Service failure"</p> <p>(MiniTest 7400 FH only)</p>	<p>Another sensor has been specified for the active batch.</p>	<p>Select or create another batch.</p>
<p>"Batch readings do not match connected sensor !"</p> <p>"Delete readings?"</p>	<p>Another sensor has been specified for the active batch.</p>	<p>Select or create another batch or add sensor data of the sensor currently being used.</p>
<p>"Please check for correct target ball size!"</p>	<p>You have probably selected a wrong target ball.</p>	<p>Make sure the adjusted target ball size matches the target ball used for measurement.</p>
<p>"Please check sensor and target ball position!"</p>	<p>Make sure there is not target ball positioned laterally to the sensor tip. Make sure to keep the sensor out off the influence of ferrite objects or magnetic fields.</p>	<p>Remove target ball from sensor.</p> <p>Keep away from ferrite objects or magnetic fields.</p>
<p>"Carry out Zero measurement and the gauge will be ready for measurement again.</p>	<p>The magnetic field of the sensor has been influenced e.g. by a target ball laterally to the sensor tip or by any magnetic field.</p>	<p>Place target ball matching to the adjusted target ball size on the sensor tip. This step is required to make the gauge ready for</p>

Target ball: (adjusted ball size)		measurement.
“Full memory capacity !”	Probable cause: You have reached maximum number of storable readings. You have reached maximum number of entries in the data base (MiniTest 7400 only)	Delete readings, batches or directories in the database which you do not need any more.
“Memory optimization in progress”	Message appears briefly on display.	Automatic procedure. No further action required.
“Check sensor connection !”	Possible cause: <ul style="list-style-type: none"> ▪ the sensor has been removed ▪ loose probe connection ▪ damaged cable ▪ defective sensor 	Please check the options. If the sensor is defective, please change it or contact after sales service.
“No sensor connected ! “ “Changes not possible !”	Sensor connecting error. Possible cause: <ul style="list-style-type: none"> ▪ no sensor connected ▪ loose probe connection ▪ damaged cable defective sensor	Please check the options. If the sensor is defective, please change it or contact after sales service.
“Sensor failure “”		Please contact after-sales service.

The following errors may be remedied by a total reset (see section 11.1)

- keyboard failure
- no measuring admitted
- illogical readings

If the gauge cannot be switched off via the ON/OFF button, remove and reinsert batteries.

15.2 Detection of Error sources (INF flag)

Measurement may be influenced by static or alternating magnetic fields and by metallic objects near the sensor.

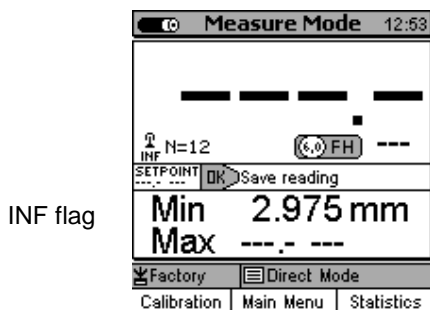

If no target ball is placed on the sensor, the “INF” flag appears on display. That means that the probe is in the infinity range.

Make sure that **INF is shown** so that **correct** readings can be taken.

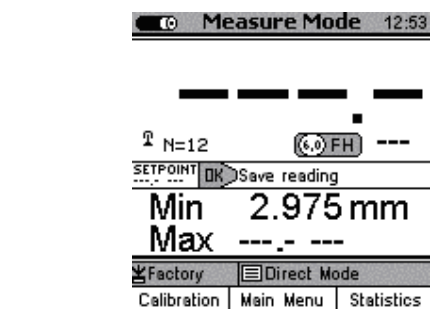

If the sensor is subject to some interference (e.g. through electro-motors, transformers, potential distribution or if a steel plate is near the sensor) the INF flag **disappears**.

Try to move the sensor a little bit in order to locate the source of interference. If you have detected the error source, move the sensor away from it. As soon as the “INF” flag appears on display, the sensor is out of the error source range and the gauge is ready again to take correct measurements.

To be sure, take double the distance from the error source.

In the default measure mode using a target ball, it is not of importance if the “INF”-flag disappears.

15.3 Statistical Terms

The statistical evaluation will help you to assess the quality of your product.

Average (Mean)

The sum of single readings divided by the total number of readings.

$$\bar{x} = \frac{\sum x}{n}$$

Standard Deviation (STD. DEV.) s (s = σ = sigma)

The sample standard deviation is a statistic that measures how “dispersed” the sample is around the sample mean. The sample standard deviation increases with increasing spread out. The standard deviation of a set of numbers is the root mean square of the variance s^2 .

$$s^2 = \frac{\sum (x - \bar{x})^2}{n-1}$$

$$s = \sqrt{s^2}$$

Variance

The variance of a list is the square of the standard deviation of the list, that is, the average of the squares of the deviations of the numbers in the list from their mean divided by the (number of readings minus 1).

Variation coefficient (Var.-coeff.)

The variation coefficient is the standard deviation divided by the arithmetic mean. The variation coefficient is indicated in percent.

$$K \text{ var} = \frac{s}{\bar{x}} \times 100\%$$

Process capability index (Cp)

The cp index is a measure of the spread of the readings as related to the specification limits. Only the spread is of importance here. The cp index is calculated as follows:

$$Cp = \frac{USL - LSL}{6s}$$

where USL = Upper specification limit

where LSL = Lower specification limit

Process capability index (Cpk)

In addition to the spread, the **cpk** index also takes into account the location of midpoint as related to the specification limits.

$$Cpku = \frac{\bar{x} - LSL}{3s}$$

$$Cpko = \frac{USL - \bar{x}}{3s}$$

$$Cpk = \text{Min} \{ Cpk_l, Cpk_u \}$$

where USL = Upper specification limit





where LSL = Lower specification limit









15.4 Safety Notes

Safe operation will be ensured as far as the instructions and notes in this manual and/or gauge will be observed.

For installation work, please cut power supply. Use only original spare parts and/or accessories.

If not in use, the sensor must always be stored with the protection tube put on it.

	<p>Risk through exposure to magnetic fields</p> <p>Within a distance of 15 cm, the sensor creates static magnetic fields of up to 1 mTesla.</p>
	<p>Pacemakers</p> <p>Patients with heart pacemakers should consult their doctor to clarify whether using the magnetic sensor may imply any health risk for them.</p>
	<p>Magnetic data carriers</p> <p>The magnetic field created by the sensor may impair the operability of magnetic data carriers, electronic devices and all kinds of encoded magnetic media. Do not place the sensor alongside computer disks, credit cards, travel cards and other magnetic media. The information contained on disks or cards may be affected by the sensor. Make sure to keep a safety distance of at least 30 cm.</p>
	<p>Keep away from monitors and electronic devices</p> <p>The magnetic field created by the sensor may impair the operability of computer or video monitors, electronic devices and measuring gauges or even destroy them. Make sure to keep a safety distance of at least 20 cm from such devices.</p>
	<p>Keep away from watches and metallic parts</p> <p>The static magnetic field created by the sensor may magnetize watches or other metallic parts. Make sure to keep a safety distance of at least 20 cm from such items.</p>

	<p>Risk of injury</p> <p>Within a distance of 15 cm, the sensor creates static magnetic fields of up to 1 mTesla. Keep a safety distance of at least 15 cm in order to avoid injury through metallic parts being attracted by the sensor.</p>
	<p>Risk of injury through metallic splinters</p> <p>The magnetic field may attract metal parts, damaging the hard metal sensor tip. Through the impact, the hard metal housing of the sensor might go into splinters.</p>
	<p>Storage batteries and accessories</p> <p>Make sure to use only original accessories and batteries supplied/recommended by the manufacturer of the gauge. Connect only to compatible peripheral devices.</p>
	<p>Connecting other devices</p> <p>If you connect the gauge to another device as recommended by the manufacturer, please refer to the corresponding instruction manual for detailed information on safety issues. Do only connect original accessories recommended by the manufacturer of the MiniTest 7200 FH / 7400 FH.</p>
	<p>Keep away from water</p> <p>The measuring unit is not waterproof. Keep in a dry place.</p>
	<p>Keep away from explosion-hazardous area</p>
	<p>Approved after-sales service</p> <p>The gauge may only be repaired by approved and qualified after-sales service personnel.</p>
	<p>Medical facilities</p> <p>Please ask for permission before using the gauge in medical facilities.</p>

15.5 Declaration of Conformity

We, ElektroPhysik, Pasteurstr. 15, D-50735 Cologne, Germany, declare in sole responsibility that the products MiniTest 7400 FH, MiniTest 7200 FH and MiniPrint 7000 to which this declaration relates is in conformity with the provisions of directive 89 / 336 / EEC (Electromagnetic compatibility), in Germany: EMVG (Gesetz über die elektromagnetische Verträglichkeit) of November, 9th, 1992.

15.6 After Sales Service

MiniTest 7200 FH / MiniTest 7400 FH models are manufactured according to state-of-the-art production methods using high-class components. Careful production controls along with a Certified Quality Management according to DIN EN ISO 9001 ensure optimum product quality.

In case of errors please contact ElektroPhysik. If repairs should become necessary, please send the gauge to ElektroPhysik or contact your local ElektroPhysik representative for return and repair instructions.

Please note that the gauge should only be repaired by authorized, skilled and trained personnel. Service attempts by untrained personnel could cause extensive damage to the gauge and possibly void any and all warranties.

For more detailed information on the use, applications, service or technical data, please contact your local ElektroPhysik representative.

Germany ElektroPhysik Dr. Steingroever GmbH & Co. KG Pasteurstr. 15 D-50735 Köln Phone: +49 221 75204-0 Fax: +49 221 75204-69 info@elektrophysik.com	USA ElektroPhysik USA 770 Algonquin Rd. Arlington Heights IL 60005 Phone : + 1 (847) 4 37-66 16 Fax +1 (847) 4 37-00 53 epusa@elektrophysik.com
The Netherlands ElektroPhysik Nederland Borgharenweg 140 NL-622 AA Maastricht Phone: +31-43 52 00 60 Fax: +31 43 363 11 68 epnl@elektrophysik.com	Belgium ElektroPhysik Belgium Rue Jouhaux 16 B-4102 Ougrée Phone : +32 4 336 52 05 Fax : +32 4 338 01 80 epbe@elektrophysik.com

Index

A

average51, 60
Average38, 40

B

backlight.....43
batteries
 inserting.....6, 10, 11, 25, 49, 51, 56, 58, 63
battery symbol.....10

C

Calibration....18, 24, 25, 26, 29, 30, 41, 42, 51
charger unit
 external.....10, 44
Configuration14, 17, 18, 20, 21, 30, 32, 34,
 35

D

Directory31, 33
display5, 7, 10, 11, 13, 14, 32, 43, 47, 56

E

entries
 alphanumeric.....15, 16, 45
 numerical.....15, 16, 45

F

factory calibration7, 8, 32
foot switch.....10

G

gauge specifications45

H

histogram.....34, 37

I

Infrared.....38

L

language.....7, 46
lower specification limit14
LSL14, 34, 61

M

Main Menu.. 14, 15, 31, 32, 33, 34, 35, 36, 37,
 40, 41, 43
Measuring Values.....38
modification lock45
multi-point calibration27, 51
multi-purpose socket.....10, 44

P

power supply unit10, 11, 51
precision standard25, 26, 27, 28, 29
Process capability
 Cp.....38
 Cp.....40
 Cpk.....40
Process capability Cpk.....38

S

sensor stand.....5, 12, 19, 20, 26
set point.....35, 51
single readings27, 30, 60
Standard deviation.....38, 40
switch off
 automatic.....49
Switch ON7

T

Total Reset7, 46
tree-structure31
trend diagram34

U

user name32, 41
USL.....14, 34, 61