

FERITSCOPE® FMP30



FERITSCOPE® FMP30

Operators Manual

**Determination the ferrite content
of austenitic and DUPLEX stainless steel and
determination of the ratio of
martensite in austenitic stainless steels**

**© 2008 Copyright by
Helmut Fischer GmbH**

**Institut für Elektronik und Messtechnik, Sindelfingen (Germany).
All rights reserved. No part of this manual may be reproduced by any
means (print, photocopy, microfilm, or any other method) or processed,
multiplied or distributed by electronic means without the written consent
of Helmut Fischer GmbH Institut für Elektronik und Messtechnik.**

Table of Contents

1 Important Information	9
1.1 Trademarks and Liabilities	9
1.2 Symbols and Conventions Used in the Manual	9
1.3 Intended Use	10
1.4 General Information	10
1.5 Requirements on the Operating Personnel	10
1.6 Power Connection	11
1.7 Environmental Conditions	11
1.8 Probe Handling	12
1.9 Handling, Storage and Transport of the Base and the Calibration Standards	13
1.10 Instrument Repairs	14
1.11 Warranty	14
2 Description of the Instrument	15
2.1 LCD-Display	16
2.2 Control Panel Key Functions	18
2.3 Accessories	23
2.3.1 Probes	23
2.3.2 Base and Calibration Standards	24
2.3.3 Printer	25
2.4 Technical Data	26
2.5 Contents of Shipment and Options	27
2.5.1 Standard Contents of Shipment of the Instrument	27
2.5.2 Options	28
3 System Setup, Maintenance and Cleaning	29
3.1 Voltage supply	30
3.1.1 Power Connection	30
3.1.2 Installing or Replacing Batteries	31
3.2 Connecting Probes	33

3.3	Instrument: On/Off	36
3.3.1	Measurement Method of the Connected Probe	36
3.3.2	Power Up	37
3.3.3	Measured Variables	40
3.3.4	Switching Off the Instrument	41
3.4	Cleaning	41
4	Probe Handling	42
4.1	Handling During Measurements	42
4.2	Assigning a New Probe	43
5	Applications	45
5.1	Setting Up an Application	45
5.2	Selecting the Desired Application	48
5.3	Deleting an Application	49
5.4	List of Set Up Applications	50
5.5	Assigning Application Designations	52
5.6	Application Specific Settings	52
5.6.1	Tolerance Limits	54
5.6.2	Measurement Display Resolution	56
5.6.3	Automatic Block Size and Block Creation	57
5.6.4	Auto-Averaging Mode	58
5.6.5	Outlier rejection	60
5.6.6	Measured Variables	61
5.7	Linking Applications	63
5.7.1	Application Linking Procedure	63
5.7.2	Enabling and Disabling the Linking Mode	64
5.7.3	Example for Linked Applications	64
6	Normalization, Calibration and Master Calibration	67
6.1	Information Regarding Normalization, Calibration and Master Calibration	67
6.2	Normalization	68
6.2.1	Normalization Procedure	69
6.2.2	Documenting the Normalization with a Printer	70

6.3	Corrective Calibration	71
6.3.1	Selecting the Calibration Standards for the Corrective Calibration	71
6.3.2	Corrective Calibration Procedure	72
6.3.3	Deleting a Corrective Calibration	75
6.3.4	Documenting the Corrective Calibration with a Printer	76
6.4	Master Calibration	77
6.4.1	Selecting the Calibration Standards	78
6.4.2	Performing a User Master Calibration	78
6.4.3	Master Calibration Procedure	79
6.4.4	Displaying Xn Ranges for Calibration Standards for the Master Calibration	83
6.4.5	Documenting the Master Calibration with a Printer	84
6.5	Determination of the Normalized Count Rate Xn of a Calibration Standard During a Master Calibration	85
7	Measuring	86
7.1	Preparing for a Measurement	86
7.2	Parameters That Influence the Ferrite Content Measurement	87
7.3	Making a Measurement	87
7.3.1	Measurement Acquisition	89
7.3.2	Measurements With External Start Enabled	90
7.3.3	Automatic Measurement Acquisition	90
7.3.4	Audible Signals After the Measurement Acquisition	93
7.3.5	Measurements With Tolerance Limits Enabled	94
7.3.6	Measurements With a Fixed Block Size	94
7.3.7	Measurements in Auto-Averaging Mode	96
7.3.8	Measurements With Outlier Rejection Enabled	97
7.4	Documenting the Measurement with a Printer	98
7.5	Erroneous Readings	101
7.5.1	Deleting Erroneous Readings	101
7.5.2	Deleting All Readings of a Block That Has Not Been Closed	101
7.5.3	Deleting All Readings of an Application	101
7.5.4	Overwriting Individual Erroneous Measurements at a Later Time	102
7.6	Measurements in the Free-Running Display Mode	104

7.6.1	Turning the Free-Running Display Mode On/Off . . .	105
7.6.2	Procedure For Making Measurements With the Free-Running Display Mode	106
7.6.3	Analog Display	107
7.7	Measurements in Standard and Matrix Measuring Mode	109
7.7.1	The Standard Measuring Mode	109
7.7.2	Making Measurements in the Standard Measuring Mode	110
7.7.3	The Matrix Measuring Mode	111
7.7.4	Making Measurements in the Matrix Measuring Mode	112
7.7.5	Assigning Block Designations	115
7.8	Correction Factors	116
7.8.1	Influence of the Specimen Curvature	116
7.8.2	Influence of the Specimen Thickness	119
7.8.3	Influence of the Cladding Thickness	120
7.8.4	Influence of the Edge Distance on the Measurement Location	122
8	Evaluation	124
8.1	Evaluation of the Current Block “Block Result”	125
8.1.1	Documenting the Block Result With a Printer	128
8.1.2	Printout of the List of Single Readings	129
8.1.3	Computed parameters - Block result	130
8.2	Evaluation of the Open Application “Final Result” . .	131
8.2.1	Documenting the Final Result with a Printer	133
8.2.2	Computed Parameters - Final Result	135
8.2.3	Histogram	136
9	Data Transfer Using USB	138
9.1	USB Connection to a PC	139
9.2	Installing the USB Drivers	139
9.3	Transfer of the Measurement Data to the Computer	140
9.3.1	Online Operation	140
9.3.2	Offline Operation	141
9.3.3	Transferring Data With a Group Separator	141
9.4	Transmission from the PC to the Instrument	141
9.4.1	Transfer Formats	141

9.4.2	Control Commands	142
9.5	Connecting a Printer	146
9.5.1	Print Output	146
10	Instrument Settings - Service Function Menu	147
10.1	Service Menu Overview	148
10.2	System	149
10.2.1	Language	149
10.2.2	Time	150
10.2.3	Date	151
10.2.4	Date format	152
10.2.5	Contrast	153
10.2.6	Lighting	154
10.2.7	Automatic Switch Off	156
10.2.8	Re-Initialization of the Instrument	157
10.3	Evaluation	159
10.3.1	Block Result	159
10.3.2	Histogram	160
10.4	USB	161
10.4.1	Output	161
10.4.2	Group Separator	162
10.4.3	Send Free-Running Mode	163
10.5	Printing	164
10.5.1	Printer Selection	164
10.5.2	Left Margin Setting	165
10.5.3	Print Individual Single Readings	166
10.5.4	Block Result	167
10.5.5	Final Result	168
10.5.6	Histogram	169
10.5.7	Auto Formfeed	170
10.6	Instrument Mode	171
10.6.1	Restricted Operating Mode	171
10.6.2	Analog Display	173
10.6.3	Matrix Mode	174
10.6.4	Linking Applications	177
10.7	Measurement	178
10.7.1	Audible Signal	178
10.7.2	Measurement Effect	179
10.7.3	External Start	180

10.7.4	Measuring Mode - Standard/Area Measurement/ Automatic Measurement	182
10.7.5	Unit	184
10.7.6	Measured Variable	185
10.8	Storage Mode	187
10.9	Performing a Master Calibration	187
10.10	About ...	188
10.11	Documentation of the Instrument Configuration	188
11	Malfunctions and Messages	190
11.1	Malfunctions	190
11.2	Messages on the LCD Display	194
12	Glossary	205
12.1	Terms and Formula Symbols	205
12.2	Additional Literature	230
12.2.1	Statistics and ferrite content measurement	230
12.2.2	Standards	231
13	Index	233

1 Important Information

1.1 Trademarks and Liabilities

FERITSCOPE® is a registered trademark of the Helmut Fischer GmbH Institute for Electronics and Metrology.



The fact that the trademark characters ® and ™ may be missing does not indicate that a name is a free trademark.

Great care has been exercised in creating this operator's manual. The Helmut Fischer GmbH Institute for Electronics and Metrology assumes no liability for potentially remaining erroneous or incomplete statements and their results. We would, however, appreciate if you can make us aware of potentially existing errors or incomplete information.

1.2 Symbols and Conventions Used in the Manual

The following symbols and conventions are used in this manual:



Indicates safety information referring to danger for persons and warnings regarding damage to the measuring instrument or to accessories.



Indicates particularly important information and hints.



Indicates a reference to a page or chapter in this manual.



Operation to be carried out by the operator at the instrument.



Listing.

ENTER

Writing convention for instrument keys and command buttons on the display.

1.3 Intended Use

The FERITSCOPE® FMP30 is to be used to determine the ferrite content of austenitic and DUPLEX steel and to determine the portion of deformation martensite in austenitic materials.

Only accessories recommended and approved by the Helmut Fischer GmbH Institute for Electronics and Metrology ( beginning on Page 23) may be connected to this instrument.

1.4 General Information



The values shown for the measured ferrite contents and the texts of the information lines of the LCD display serve as examples for possible displays. It is entirely possible that different values appear on the LCD display or in the printout without having made any mistakes.

1.5 Requirements on the Operating Personnel



The instrument should be operated only by staff trained for this purpose!

In addition, basic knowledge of metrology according to DIN 1319 is essential for performing correct ferrite content measurements and evaluations.

Basic computer knowledge regarding configuration, operation and programming as well as knowledge of the software in use, which may be obtained from respective instruction manuals, is required when using the instrument in conjunction with a computer.

1.6 Power Connection



To avoid damage to the instrument or wrong measurement results due to a wrong line voltage, the instruments must be connected to a power outlet only via the AC adapter provided by Helmut Fischer GmbH Institute for Electronics and Metrology. The line voltage must agree with the line voltage rating stated on the nameplate of the AC adapter.

1.7 Environmental Conditions

EMC

The instrument complies with the laws concerning electromagnetic compatibility of instruments (2004/108/EC). The measured values are not influenced by the highest level of interference mentioned in the EN 61000-6-2 Standard (which references the Standards EN 61000-4-2, EN 61000-4-3 and EN 61000-4-4). In particular, the instrument is shielded effectively from strong electromagnetic fields (e.g., motors, power lines, radio transmission towers).

Low Voltage

The instrument adheres to the Low Voltage Directive 2006/95/EC.

Ambient Temperature Range During Operation: +10°C ...+40°C

Temperature Range During Storage and Transport: +5°C ... +60°C



Temperature behind glass panes (e.g., in cars) in direct sunlight easily rise above 60°C!

To avoid damage from heat, do not store the instrument or accessories in such places.



The instrument and accessories (in particular the AC adapter) must not come in direct contact with water! Risk of electrical shorts! Instruments or accessories may be operated, kept or stored only in places, where the relative humidity is between 30% and 90% (non-condensing).



Because the instrument and accessories are not acid resistant, avoid direct contact with acid or acidic liquids.



The instrument and accessories are not suited for operation in explosion-hazard areas!



Protect the instrument and accessories from static charges! Electrical discharges may damage internal components or delete internal memories.

1.8 Probe Handling



To avoid breakage of the wiring, do not bend the probe connector cable! The radius of rolled up probe connector cables should always be at least 50 mm!

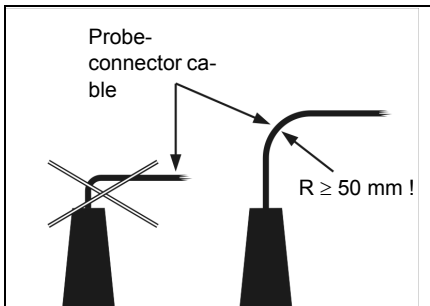

Fig. 1-1 Probe handling

During the measurement, the magnetic poles of the probes are placed directly onto the specimen. Observe the following to keep wear of the magnetic poles during the contacting measurement to a minimum:



Place the probes speedily yet gently on the specimen surface! Avoid hard impacts!



Do not drag the probe across the specimen surface.



Do not place standard probes on hot or acid-wetted surfaces; do not immerse them in liquids. Special probe models are available for such applications (ref. the probe data sheets of the brochure “Measurement Probes and Measurement Aids - Optimized Probes”). You can obtain this brochure from the Helmut Fischer GmbH Institute for Electronics and Metrology or from your authorized supplier.

1.9 Handling, Storage and Transport of the Base and the Calibration Standards

The instrument is normalized and calibrated using a base and calibration standards (ferrite standards).

Proper condition of the calibration standards is an important prerequisite for a correct calibration, and thus for a correct measurement.

Observe the following to ensure the proper condition of the calibration standards:



To keep wear of the base and the calibration standards during the contacting measurements to a minimum, use them for the calibration only and not for test measurements!



Do not soil or scratch calibration standards!
Replace corroded or scratched calibration standards or those with strong indentations with non-damaged, clean standards.



To protect the calibration standards from dirt or damage, keep them in their supplied case for transporting and storing.

1.10 Instrument Repairs

No repairs should be performed on the instrument.



The instrument may be opened only for replacing rechargeable or regular batteries ( Page 31). Other service operations on the instrument or the accessories must be performed only by technical personnel authorized by the Helmut Fischer GmbH Institute for Electronics and Metrology.

1.11 Warranty

The Helmut Fischer GmbH Institute for Electronics and Metrology will assume no warranties in the following instances:

- Use of instrument or accessories for purposes other than the intended use.
- Connection of accessories not recommended or approved by the Helmut Fischer GmbH Institute for Electronics and Metrology.
- Repairs or structural changes to the instrument or accessories that have not been carried out by authorized persons.
- Improper handling of instrument or accessories (e.g., use in explosion-hazard or very hot environments).
- Disregard of information in this operator's manual.

2 Description of the Instrument

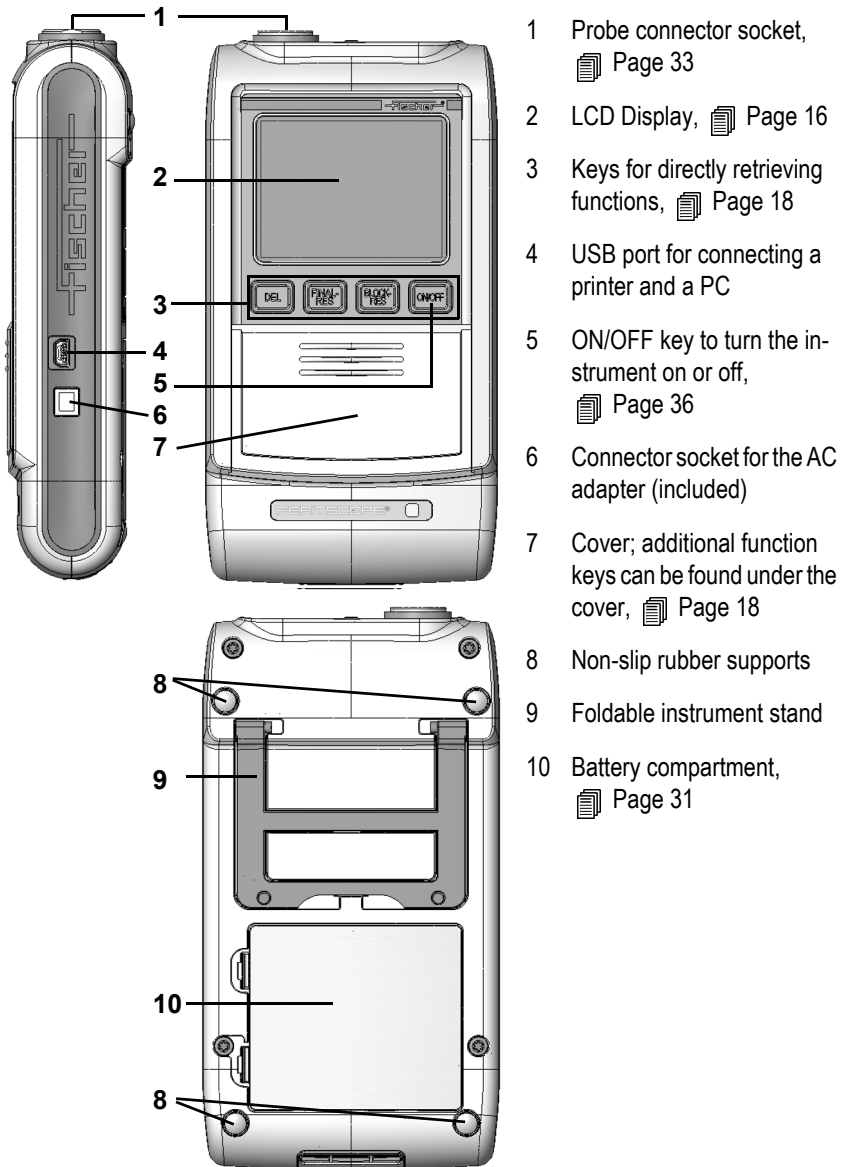

- 1 Probe connector socket, Page 33
- 2 LCD Display, Page 16
- 3 Keys for directly retrieving functions, Page 18
- 4 USB port for connecting a printer and a PC
- 5 ON/OFF key to turn the instrument on or off, Page 36
- 6 Connector socket for the AC adapter (included)
- 7 Cover; additional function keys can be found under the cover, Page 18
- 8 Non-slip rubber supports
- 9 Foldable instrument stand
- 10 Battery compartment, Page 31

Fig. 2-1 Front and rear view of the instrument, connections

2.1 LCD-Display

The LCD display consists of several display elements. When powering up the instrument using **ON/OFF** ( Page 36), all display elements will appear briefly at the same time.

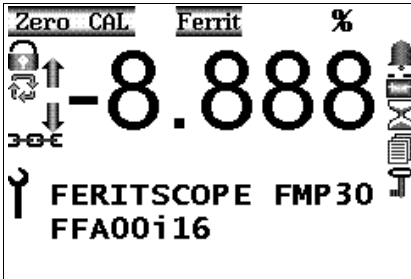

























Fig. 2-2 Display elements of the LCD display after power up (example)

Display element	Explanation
	A normalization is performed (on the base of the calibration standard set) ( beginning on Page 68).
	A calibration is carried out ( beginning on Page 71).
	Displays the measurement method
	Bell: Tolerance limits are enabled ( beginning on Page 94).
	Padlock: Restricted operating mode is enabled, i.e., the keys MENU , ZERO and CAL are not active, the service functions cannot be retrieved, applications cannot be deleted ( beginning on Page 171).

Display element	Explanation
	<p>Arrow circle: “Free-running display” is enabled, measurements are displayed continuously when the probe is placed on the specimen ( beginning on Page 104).</p> <p>Alternatively: Area measurement display  Automatic measurement display </p>
	<p>Arrow up: Upper specification limit is exceeded.</p>
	<p>Arrow down: Measurement below lower specification limit.</p>
	<p>Both arrows together: The displayed measurement was recognized as an outlier.</p>
<p>-8.8.8.8</p>	<p>Numeric elements for presenting readings, errors and warning messages.</p>
<p>MS/m μm % mils % mm FN</p>	<p>Unit of measurement for the displayed reading.</p>
	<p>Battery: The battery must be replaced or the rechargeable battery must be charged because the voltage dropped below a minimum value ( beginning on Page 30).</p>
	<p>Hourglass: Measurements are currently not possible because an instrument-internal routine is running.</p>

Display element	Explanation
	Chain: Applications that have been set up using the same probe are linked to each other, i.e., the same normalization and/or corrective calibration is used for determining the measurements for these Applications ( beginning on Page 63).
	Sheets: Matrix measuring mode is enabled ( beginning on Page 111).
	Key: Measurement block is closed.
...SCOPE ... FKA...	Information lines: Instrument type: Instrument-internal software version

2.2 Control Panel Key Functions



For easier opening of the cover:







- 1.** Press on the corners of the cover and then
- 2.** slide the cover downwards.

Fig. 2-3 Opening the cover of the control panel keys

The following overview provides a brief description of the functions of the individual control panel keys:

Key	Function
DEL	<p>Deletes the last measured reading Repeated pressing of DEL: Deletes the readings of the open block in succession. 2 x DEL: Deletes all readings .. during normalization: 1x DEL - Deletes the last reading, 2x DEL - Deletes the measurement series of the base material .. during calibration: 1x DEL - Deletes the last reading, 2x DEL - Deletes the measurement series of the current calibration standard. Repeated pressing of DEL: Deletes the measurement series of the previous calibration standard ( beginning on Page 101). .. in all menus: DEL - Returns to the previous menu or cancels the procedure.</p>
FINAL-RES	<p>Retrieving the final result ( beginning on Page 131)</p> <p>Repeated pressing of FINAL-RES: Displays the individual components of the final result (mean value, standard deviation, etc.) in succession. .. and then ENTER: Ends the display of the final result (return to the measurement screen) without deleting the stored values (the current measurement block will not be closed). .. and then DEL: Ends the display of the final result (return to the measurement screen) and deletes the values stored in the open Application. .. during calibration or normalization: Enabling and disabling the “free-running” display mode (display of the normalized countrates of the readings; readings will not be stored and will not be integrated in the calibration or normalization) or with external start enabled: Triggers a measurement.</p>

Key	Function
BLOCK-RES	<p>Retrieves the block result ( beginning on Page 125)</p> <p>Repeated pressing of BLOCK-RES: Displays the individual components of the block result (mean value, standard deviation, etc.) in succession.</p> <p>.. and then ^: Ends the display of the block result (return to the measurement screen) without closing the open measurement block (the current measurement series can be continued).</p> <p>.. and then ∇: Displays the block result of the previous or following measurement block of the open Application. All block results of the open Application can be retrieved in succession through repeated pressing of ∇.</p> <p>.. and then PRINT: Prints the displayed block result.</p> <p>.. and then MENU: Displays the single readings of the evaluated measurement data block (then all single readings can be displayed by pressing ^ or ∇). Pressing MENU again ends the single reading display.</p> <p>.. and then DEL: Deletes the readings of the last measurement data block that has not been concluded and ends the display of the block result (return to the measurement screen).</p> <p>.. and then ENTER: Ends the display of the block results (return to the measurement screen) and closes the current block. The next measurement opens a new block.</p>
ON/OFF	Turns the instrument on and off ( beginning on Page 36)
ZERO	Retrieves the normalization ( beginning on Page 68)
CAL	<p>Retrieves the corrective calibration ( beginning on Page 71)</p> <p>.. and then CAL: Cancels the corrective calibration.</p> <p>.. and then DEL: Deletes the corrective calibration of the open Application.</p>

Key	Function
^	<p>With Application selection and tolerance limit input: Changes the information displayed on the LCD display. With the calibration: Sets the target value of the used calibration standard that will be displayed after the “CAL Target” notification. With parameter selection: Selects the desired parameters.</p> <p>The display will change faster if ^ is pressed for longer than 3 seconds.</p> <p>with external start enabled: Triggers a measurement.</p>
v	<p>Turns the “free-running” display mode on/off.</p> <p>With Application selection and tolerance limit input: Changes the information displayed on the LCD display. With the calibration: Sets the target value of the used calibration standard that will be displayed after the “CAL Target” notification. With parameter selection: Selects the desired parameters.</p> <p>The display will change faster if v is pressed for longer than 3 seconds.</p>
APPL No	<p>Selects the desired Application.</p> <p>.. and then DEL: Deletes the selected Application; .. and then APPL No: Displays the probes assigned to the Applications. .. and then ^ or v: Selects the desired Application. .. and then ENTER: Confirms the selection of the desired Application and returns to the measurement screen.</p>

Key	Function
MENU	<p>Displaying and entering of the application-specific settings:</p> <ul style="list-style-type: none"> ● Tolerance Limits ● Resolution ● Block size ● i individual values ● Outlier <p>.. and then \wedge or \vee: Selects the settings to be edited .. and then PRINT: Prints or displays a print form of the instrument configuration. .. and then ENTER: Confirms the selection of the setting to be edited. .. and then DEL: Exits the application-specific settings and returns to the measurement screen.</p>
PRINT	<p>Output of the values stored in the selected application (including the block results) to a printer or transfer of these values to a connected computer.</p>
 ENTER	<p>Confirms entries</p> <p>5 x ENTER: Calls the service functions The instrument settings in the Service Functions menu are password-protected. "157" will be displayed after pressing ENTER 5 times. Press \wedge, 2 times to increase this value to the factory-default password "159" and confirm the entry with ENTER.</p>

2.3 Accessories

2.3.1 Probes

All probes that can be connected to the instrument are equipped with a memory chip, a so-called EEPROM, in their connector plug. Probe-specific information (such as probe type, production number, measurement method or coefficients of the master characteristic, for example) is stored permanently - even without power supply - in this memory chip, which can be overwritten as many times as desired.

When powering up the instrument, this information is automatically retrieved and processed by the instrument; the instrument “recognizes” the connected probe.

Correct measurements can be performed only if the probe that is assigned to the open Application is used for the measurement. ( Chapter 4.2 ‘Assigning a New Probe’, beginning on Page 43).



Fig. 2-4
Probe plug of an
FGAB 1.3-Fe
probe

Various probe models are available for measurements on objects with different shapes and different surface properties. Special probes with different measurement ranges are available for the following areas of application, for example:

- particularly rough or abrasive surfaces
- Particularly soft surfaces
- damp, acidic contamination on the surface
- particularly thick or thin coatings
- hot surfaces
- Coatings in pipes and bore holes

For available probe models and the probe model best suited for your application, see the respective probe data sheets of the brochure “Measurement Probes and Measurement Aids - Optimized Probes”. You can obtain this brochure from Helmut Fischer GmbH or from your authorized supplier.

2.3.2 Base and Calibration Standards

A so-called base is used for the normalization; for the corrective calibration, one, two or three calibration standards (ferrite standards) are used in addition to the base.

Different calibration standard sets (corrective sets) are available for the corrective calibration of the instrument for the different measurement ranges. The calibration standard sets include:

- Base
- 3 calibration standards with ferrite contents according to the desired measurement range

A probe-specific calibration standard set for the master calibration (can be ordered as an option) and a probe-specific calibration standard set for the corrective calibration (included with the probe) are available for each probe model and have been compiled specifically for this probe model.

You can obtain additional calibration standards on request from Helmut Fischer GmbH Institute for Electronics and Metrology or from your authorized supplier.

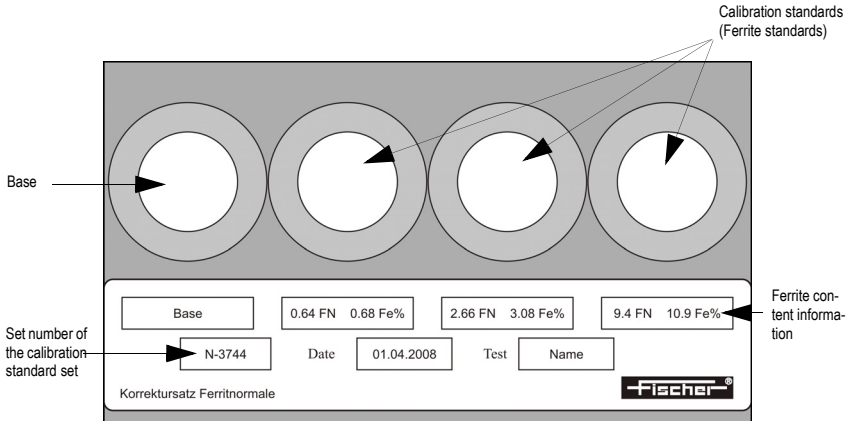

Fig. 2-5 Calibration standard set (example)



The measurements for the corrective calibration must be performed on the base and on the calibration standard! Measurements on the plastic surrounding the base or calibration standard will lead to erroneous measurements.



The measurements for the normalization and for the calibration should be made within a radius of 10 mm from the center of the base or the calibration standard, respectively.

You can obtain information about available calibration standard sets from the Helmut Fischer GmbH Institute for Electronics and Metrology or from your authorized supplier.

Certification of the Calibration Standards

The Helmut Fischer GmbH Institute for Electronics and Metrology supplies calibration standard sets complete with a valid certificate.



The certificate includes information about warranties and monitoring of the test devices.

2.3.3 Printer

For an overview of printers suitable to be connected to the instrument see the menu **Service Functions / PRINT** ( Chapter 10.5.1 'Printer Selection', beginning on Page 164).



For information about operation, maintenance and care of the printer, consult the instruction manual of the printer.

2.4 Technical Data

Instrument model	FERITSCOPE® FMP30
Display	Graphical backlit LCD display
Measurable coatings	<ul style="list-style-type: none"> ● Ferrite content measurements in weld seams and claddings made of austenitic or duplex steel ● Determination of the portion of deformation martensite in austenitic materials
Measuring modes	Magnetic induction measurement method
Dimensions	<ul style="list-style-type: none"> ● Instrument: 170 mm x 90 mm x 35 mm (L x W x H) ● LCD display: 44 mm x 57 mm (L x W)
Weight	approx. 340 g (without probe, ready to operate)
Permissible ambient temperature during operation	+10 °C ... +40 °C
Permissible storage temperature	+ 5 C° ... + 60 °C
Permissible relative air humidity	30 ... 90% (non-condensing)
Power supply	<ul style="list-style-type: none"> ● 4 x 1.5 V batteries with about 50 h service life, (Size AA or Mignon) or ● 4 x 1.5 V NiMH rechargeable batteries with about 45 h service life at 2100 mAh, (Size AA or Mignon) ● AC adapter 9 V 150 mA, 100V - 230 V
Power consumption	<ul style="list-style-type: none"> ● 0.3 W with the LCD display not illuminated ● 0.5 W with the LCD display illuminated
Connectors	<ul style="list-style-type: none"> ● Probe: 10-pin round plug ● AC adapter: 2-pin barrel connector ● Mini USB port for connecting a printer and a PC
Minimum time between two measurements	About 0.2 seconds in the free-running mode
Minimum lift-off distance between two measurements	min. 25 mm

Measurement range, trueness and repeatability precision	Depends on the connected probe (These and other probe characteristics can be obtained from the brochure “Measurement Probes and Measurement Aids - Optimized Probes”) of Helmut Fischer GmbH Institute for Electronics and Metrology or can be requested from your authorized supplier or directly from Helmut Fischer GmbH Institute for Electronics and Metrology.)
--	--

2.5 Contents of Shipment and Options

After receiving the shipment, packaging and content should be checked for potential damage. If the packaging, the content or the accessories show signs of damage, retain the packaging. It might be needed to assert a claim for damages versus the shipping company.

It is also advisable to keep the packaging for future transport.

Also verify that all components of the standard content of the shipment and all ordered options are present. Notify your authorized supplier or he Helmut Fischer GmbH Institute for Electronics or Metrology if this is not the case.

2.5.1 Standard Contents of Shipment of the Instrument

The standard contents of shipment of the instrument includes:

- Instrument
- Batteries
- Interface cable FMP/PC,
- Carrying and storage case, carrying strap
- CD-ROM with operator's manual and USB drivers
- Brief guide (short form operator's manual)

2.5.2 Options

Available options are:

- AC adapter
- Various measurement probes
- Master and corrective calibration standards sets %Fe/FN
- 1.5 V NiMh rechargeable battery (4 each/unit)
- Charger for NiMh battery
- Support stand V12 for reproducible positioning of measurement probes on the specimen
- Jig for angle probes for use in the support stand V12 (e.g., for probe FGABW 1.3)
- Jig for inside probes for use in the support stand V12 (e.g., for probe FGABI 1.3-150 mm)
- Support stand V12-AM for motor-controlled touch-down and lift-off of measurement probes
- Guide device V5GW2/TW3 for angle probes for measurements at recessed or hard to reach areas
- PC-Datex software for transferring measurement data from the instrument to a Microsoft® Excel spreadsheet (add-in module for Microsoft® Excel beginning with Version 95 under Windows® 95 to Windows® Vista)

3 System Setup, Maintenance and Cleaning



Connect or disconnect plug-type connectors only when the instrument is switched off in order to avoid electrical discharge. Connecting the AC adapter or inserting a battery should be done carried out with the unit turned off as well! Even a small discharge can delete the instrument memory.







Do not tilt the plug when inserting or unplugging them; doing so could damage the contact pins of the plugs.



The information in the chapter “1 Important Information” must be observed!

System setup consists of the following steps:

- Providing the power supply for the instrument
( 3.1 ‘Voltage supply’, beginning on Page 30)
- Connecting a measurement probe to the instrument
( 3.2 ‘Connecting Probes’, beginning on Page 33)
- Connecting a printer (where applicable) to the instrument
( 9.5 ‘Connecting a Printer’, beginning on Page 146)
- Connecting a computer (if desired) to the instrument
( 9 ‘Data Transfer Using USB’, beginning on Page 138)
- Selecting the language for the instrument if your language has not been set when the instrument was shipped
( 10.2.1 ‘Language’, beginning on Page 149)

3.1 Voltage supply

Electrical power can be supplied to the instrument in the following ways:

- with AC adapter (9 V 150 mA, 100 V - 230 V),
- 4 x 1.5 V batteries (AA or mignon) or
- 4 x 1.5 V NiMh rechargeable batteries, 2100 mAh (AA or mignon).

3.1.1 Power Connection



To avoid damage to the instrument or wrong measurement results due to a wrong line voltage, the instruments must be connected to a power outlet only via the AC adapter provided by Helmut Fischer GmbH Institute for Electronics and Metrology. The line voltage must agree with the line voltage rating stated on the nameplate of the AC adapter.

To connect the instrument to the line voltage via the AC adapter, the AC adapter must be connected to the instrument and to the line power outlet. The instrument must be switched off for this purpose!

3.1.2 Installing or Replacing Batteries



Indicator for battery replacement. Batteries or rechargeable batteries should be replaced.



If the battery voltage is too low, the instrument will turn off automatically.

Procedure Battery Replacement

1. Use **ON/OFF** ( Page 36) to switch the instrument off (if not yet done).
2. Place the instrument with its back pointing up on the table. Open and remove the battery compartment cover on the rear of the instrument as depicted below.

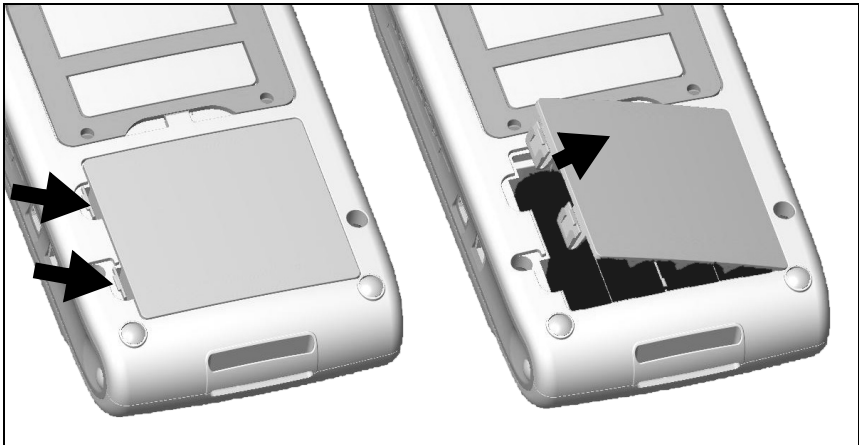

Fig. 3-1 Opening the battery compartment cover

3. If old batteries are in the instrument, remove them from the unit. Otherwise, install new batteries directly; observe the correct polarity of the batteries



Disposal: Do not dispose of batteries with regular household waste! Place damaged or used batteries / rechargeable batteries in designated collection containers! Please observe the guidelines in your region concerning proper handling of waste electrical and electronic equipment and accessories.

4. Close the battery compartment cover.

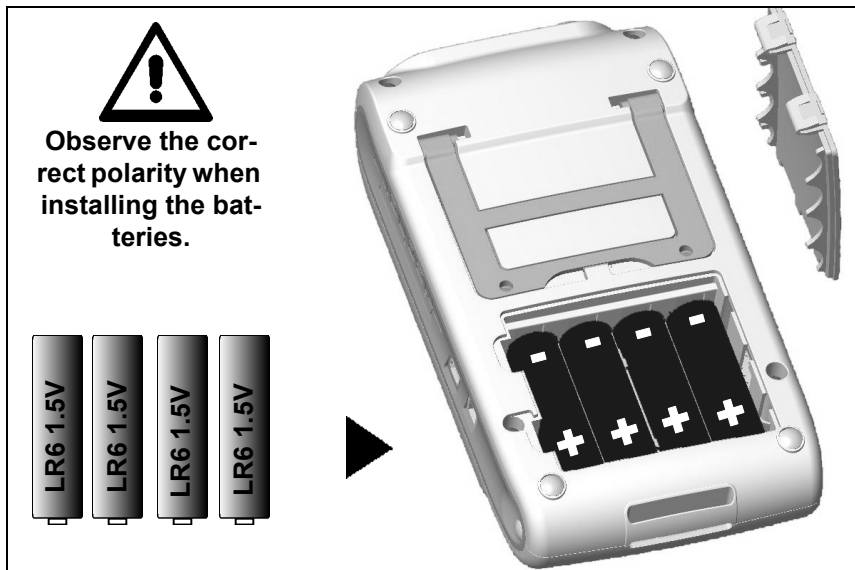

Fig. 3-2 Inserting the batteries and closing the battery compartment cover



Use only type MIGNON, 1.5 V, LR6 - AA - AM3 - MN1500 batteries or 4 individual rechargeable batteries 1.2 V 2400 mAh Type AA. Using other batteries may lead to instrument damage.



Use only non-damaged batteries/rechargeable batteries.

3.2 Connecting Probes



Connect probes only when the instrument is off!

To turn the instrument off: Press the ON/OFF key on the right side of the control panel. The LCD display is not backlit and no characters are visible.



Protect the instrument and accessories from electrostatic charges!

Electrical discharges may damage internal components or delete internal memories.

Such discharges may occur, for example, when connecting the probe to the instrument. Thus, please ensure that the person connecting a probe is properly grounded.

It is recommended to store the instrument with the connected probe.

- 1.** Use **ON/OFF** ( Page 36) to switch the instrument off (if not yet done).
- 2.** If the probe connected to the instrument is to be replaced, unscrew the knurled nut of the probe plug completely and pull the probe plug carefully from the connector socket of the instrument.
- 3.** Plug the probe plug of the new probe into the probe connector socket of the instrument.



When inserting the plug, ensure that the key of the plug fits into the groove of the socket. Otherwise, an erroneous connection between the instrument and the plug may occur or the contact pins of the probe plug may be damaged.

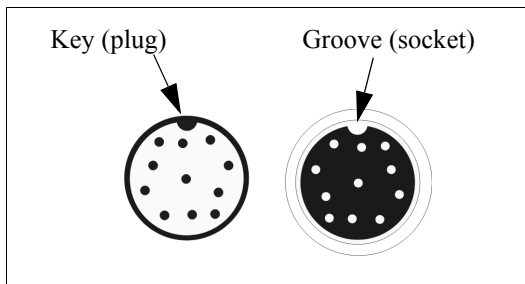

Fig. 3-3 Probe plug and probe connector socket

4. Tighten the knurled nut of the probe plug.

Hold the plug tight to avoid an unintentional turning of the probe plug.



To avoid damage to the contact pins of the probe plug, only the knurled nut may be turned! The probe plug must not be turned in the connector socket.

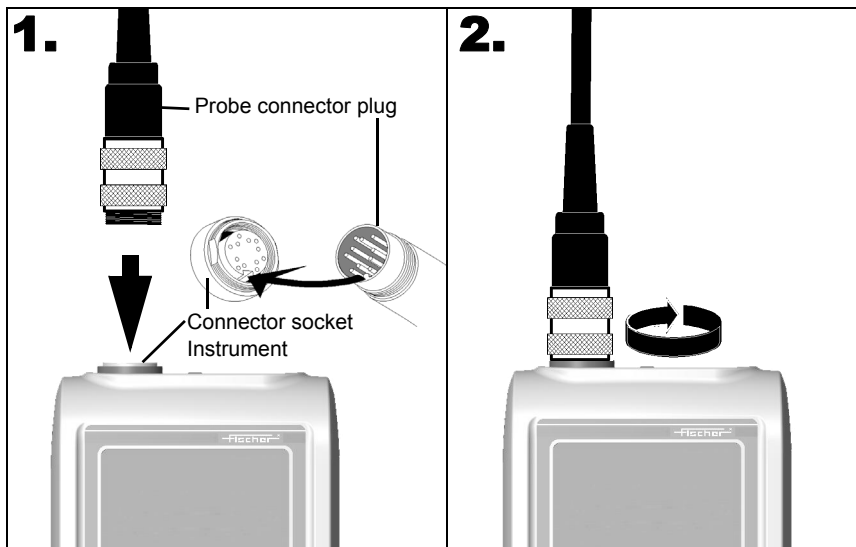

Fig. 3-4 Connecting a probe

5. Use **ON/OFF** to turn the instrument on again. The instrument automatically recognizes the type of probe connected to it.

Exception: A flashing symbol for the measurement method on the LCD display indicates that the instrument does not recognize the connected probe. In such a case:

- A new Application must be set up for the connected probe (☞ 5.1 'Setting Up an Application', beginning on Page 45) and/or
- The probe must be assigned to the instrument or to the respective Application, respectively (☞ 4.2 'Assigning a New Probe', beginning on Page 43) or
- The probe that has been linked to the respective Application thus far must be reconnected.



A new corrective calibration must be performed after the probe has been assigned (☞ Page 71)!

3.3 Instrument: On/Off



To avoid erroneous readings, no metallic objects must be in close proximity to the probe tip when powering up the instrument.

The minimum distance is 25 mm.

3.3.1 Measurement Method of the Connected Probe

After powering up the instrument, the measurement method **[Ferrite]** appears on the LCD display. The unit of measurement for displaying the readings of the current Application is displayed next to it ( 10.7.5 'Unit', beginning on Page 184).

Unit	Explanation
Fe %	Ferrite content in ferrite percent
FN	Ferrite content in ferrite numbers







If **[Ferrite]** flashes on the display, an Application has not yet been set up using the connected probe. It is not possible to make measurements when the display is flashing.



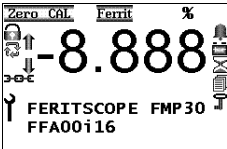

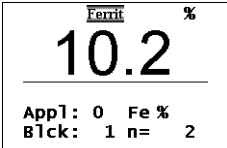
To make measurements, an Application must be set up using the connected probe

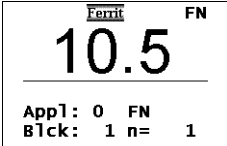
( 5.1 'Setting Up an Application', beginning on Page 45).

3.3.2 Power Up

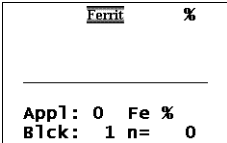
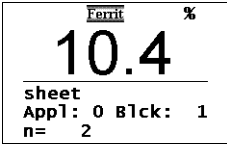
Key sequence	Detail of the LCD display	Explanation
ON/OFF		<p>Press the ON/OFF key to power up the instrument.</p> <p>An audible signal will sound.</p> <p>A monitoring routine will run. All display elements of the LCD display will appear briefly at the same time ( Page 16).</p> <p>At the end of the monitoring routine, the Application that was used the last time to make measurements with the connected probe will open automatically and the instrument is ready to make measurements. The last reading of the last not closed block appears.</p>
		<p>[%] or [FN]: Unit of measurement for the displayed reading (Setting:  10.7.5 'Unit', beginning on Page 184)</p> <p>[Appl:]: No. of the open Application</p>
		<p>[B1ck:]: Number of the current block</p> <p>[n=]: Number of single readings stored in the current block</p>

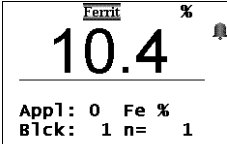
Alternatively to the LCD displays presented above, the following displays may appear after power-up:

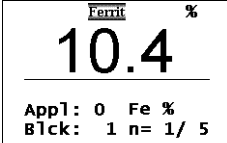
Detail of the LCD display	Explanation of the LCD displays after power up
 <p style="text-align: center;">Ferrit %</p> <hr/> <p>App1: 0 Fe % Blck: 1 n= 0</p>	<p>No reading appears after powering up the instrument because the last not closed block does not contain any readings.</p> <p>If the settings in the Service function Storage mode are [do not save] or [delete upon off], no reading will appear upon power up as well because the readings have either not been stored at all or have been deleted when the instrument was switched off.</p> <p>(📖 10.8 'Storage Mode', beginning on Page 187)</p>
 <p style="text-align: center;">Ferrit %</p> <p style="font-size: 2em; text-align: center;">10.4</p> <hr/> <p>sheet App1: 0 Blck: 1 n= 2</p>	<p>A designation (in this case "sheet") has been assigned to the open Application.</p> <p>(📖 5.5 'Assigning Application Designations', beginning on Page 52)</p> <div style="text-align: center;">  </div> <p>Once a designation has been assigned to an Application, it appears in the information lines of the LCD display, where applicable alternating with the Application number.</p>
 <p style="text-align: center;">Ferrit %</p> <p style="font-size: 2em; text-align: center;">10.4</p> <hr/> <p>App1: 0 Fe % Blck: 1 n= 1</p>	<p>The tolerance limits are enabled in the open Application: </p> <p>(📖 5.6.1 'Tolerance Limits', beginning on Page 54 and 7.3.5 'Measurements With Tolerance Limits Enabled', beginning on Page 94).</p>
 <p style="text-align: center;">Ferrit %</p> <p style="font-size: 2em; text-align: center;">10.4</p> <hr/> <p>App1: 0 Fe % Blck: 1 n= 1/ 5</p>	<p>The open Application is set to automatic block creation (📖 5.6.3 'Automatic Block Size and Block Creation', beginning on Page 57 and 7.3.6 'Measurements With a Fixed Block Size', beginning on Page 94).</p> <p>[n=]: Number of the single readings stored in the current / Block size</p>

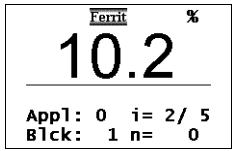

Detail of the LCD display	Explanation of the LCD displays after power up
---------------------------	--



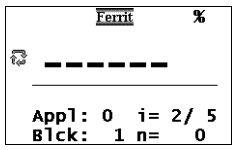

The open Application is set to auto-averaging mode ( 5.6.4 'Auto-Averaging Mode', beginning on Page 58 and 7.3.7 'Measurements in Auto-Averaging Mode', beginning on Page 96).

[i=]: Number of single readings measured using the auto-averaging / set number of single readings to be combined



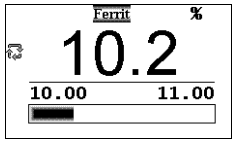

The open Application is set to the "free-running" display mode:  ( 7.6 'Measurements in the Free-Running Display Mode', beginning on Page 104)



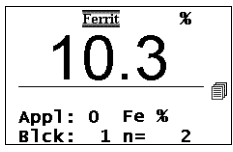

The open Application is set to the "free-running" display mode:  and analog display is enabled ( 7.6 'Measurements in the Free-Running Display Mode', beginning on Page 104 and 10.6.2 'Analog Display', beginning on Page 173).

[10.00 11.00]: Limits of the analog display (example)



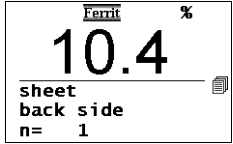

Matrix measuring mode is enabled:  ( 7.7 'Measurements in Standard and Matrix Measuring Mode', beginning on Page 109 and 10.6.3 'Matrix Mode', beginning on Page 174).



Matrix measuring mode is enabled:  ( 7.7 'Measurements in Standard and Matrix Measuring Mode', beginning on Page 109 and 10.6.3 'Matrix Mode', beginning on Page 174).

In addition, a designation each has been assigned to the open Application ("sheet") and to the current block ("back side") ( 5.5 'Assigning Application Designations', beginning on Page 52 and 7.7.5 'Assigning Block Designations', beginning on Page 115).

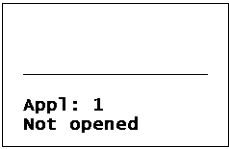
Detail of the LCD display	Explanation of the LCD displays after power up
	<p>This error message appear briefly after power-up if no probe is connected to the instrument, if the probe is not connected properly or if the connected probe is defective. It is not possible to make measurements without a connected probe.</p> <p>(📖 3.2 'Connecting Probes', beginning on Page 33).</p>
	<p>This warning appears briefly after power-up if a probe other than the last one used is connected to the instrument.</p> <p>(📖 4.2 'Assigning a New Probe', beginning on Page 43).</p>
	<p>The current Application has not yet been set up. To make ferrite content measurements, an Application must be set up using the connected probe</p> <p>(📖 5.1 'Setting Up an Application', beginning on Page 45).</p>

3.3.3 Measured Variables

(📖 Chapter 10.7.6 'Measured Variable', beginning on Page 185)

Depending on the measured variable selected for display,

- Fe % or FN (display of the ferrite content in ferrite percent or in ferrite numbers),
- normalized countrate X
- Countrate X
- Fe % / FN and Xs
- Xn and Xs

may appear on the display.

3.3.4 Switching Off the Instrument

Press the **ON/OFF** key switch the instrument off manually.

The instrument shuts down automatically if for about 5 minutes no measurements are made or no key is pressed.

3.4 Cleaning



To avoid damage to the instrument due to electrical shock, the line plug of the AC adapter must be pulled before cleaning the instrument or the accessories!

Soiled instruments or accessories should be cleaned using a plastic care product and a soft cloth.

The following should be observed during cleaning:



Risk of electrical shorts!
Water or other liquids must not enter the instrument or the accessories! Do not immerse or place the instrument or accessories into liquids to loosen dirt through soaking! Do not pour liquids of the instrument or accessories!



Wipe off dirt immediately to avoid it from drying onto the surface!



Do not use aggressive agents to clean the instrument or the accessories because they could attack the plastic housing!



To prevent damage, avoid scraping as a means of cleaning off dirt, in particular in the area of the probe tip.



Do not use aggressive agents to clean the calibration standards because they could damage the calibration standards! The use of damaged calibration standards (e.g., soiled or scratched standards) will lead to wrong measurement results! (Additional information:  1.9 'Handling, Storage and Transport of the Base and the Calibration Standards', beginning on Page 13)

4 Probe Handling

4.1 Handling During Measurements

- Always hold the probe at its grip sleeve (right figure).
- Always place the probe gently and at a right angle on the specimen surface.
- Slide the grip sleeve to the specimen surface such that the sleeve rests on the specimen (center and bottom Figure, right).
- With the default setting, a beep will signal the measurement capture.
- Lift the probe off the specimen before making the next measurement.

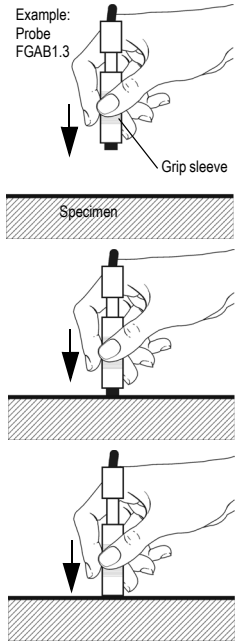

Avoid hard impacts.

Do not allow the probe to hover directly above the surface. Doing so will lead to erroneous readings.

Do not bend the probe connector cable! Doing so can lead to broken wires.

4.2 Assigning a New Probe

The instrument recognizes if the probe connected to the unit is different than the one expected according to the probe identification in the current Application. Reason: Each individual probe has a name that is comprised of the identification number and the model designation (e.g., FGAB 1.3F). The probe must be “registered” in the instrument under this name.

Potential Causes of the Problem:



- The probe received a different identification number after a repair.
- A newly purchased probe has not yet been assigned.
- If a user has more than one probe of the same probe model, a problem occurs if a not yet assigned probe is connected to the instrument. In such a case, it is advisable to identify the probes and/or instruments with numbers.

If the measurements of an opened Application have not been made with the connected probe, [Ferrite] will flash on the display.





The corrective calibrations are deleted when the probe is assigned to one or more Applications; the user will have to perform a new corrective calibration for each of these Applications ( 6.3 ‘Corrective Calibration’, beginning on Page 71).

How to assign a probe to an Application:

1. Use **ON/OFF** ( Page 41) to switch the instrument off.
2. Connect the new probe ( Page 33).
3. Use **ON/OFF** to turn the instrument on ( Page 37).

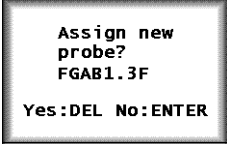
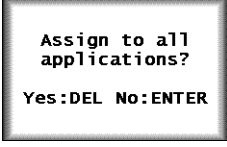
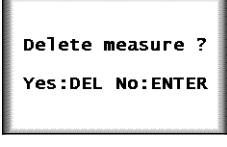
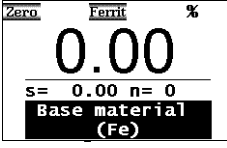
Key sequ. / Action	Detail of the LCD display	Explanation
		This warning appears briefly after power-up if a probe other than the last one used is connected to the instrument. After that, the display of the measurement method flashes.

Key sequ. / Action	Detail of the LCD display	Explanation
4. ZERO		Example: FGAB1.3F = Name of the connected probe DEL : Probe assignment starts ENTER : Probe will not be assigned, measurement method display flashes
5. DEL		DEL : Probe will be assigned to all Applications ENTER : The probe will be assigned only to the current Application
6. DEL		DEL : All stored readings will be deleted; the probe will be assigned to the current Application / all Applications ENTER : The probe will not be assigned, measurement method display continues to flash
7.		ZERO appears on the display. A normalization is required ( beginning on Page 68). [Base material (Fe)] : The measurements for the normalization should be made on base. ENTER : Cancels the normalization.

5 Applications

All relevant settings and parameters for a measuring application as well as the captured measurement data are stored in a file - we refer to this file as an Application.

The instrument has the capability of setting up up to 100 different Applications. A maximum of 20,000 readings can be stored in these Applications. The measurements can be combined in up to 4,000 blocks.



Due to the magnetic induction measuring method, which captures all ferromagnetic components in the same manner, the measurements are always stated in ferrite. No distinction is made between the different material components, such as ferrite and martensite.

An Application consists of:

- Single readings,
- Application-specific settings, and the
- Coefficients that have been determined during the normalization and corrective calibration (used for adapting the master characteristic stored in the probe plug to the current measuring application).

5.1 Setting Up an Application



A probe must be connected and an application must be set up before measurements can be made in an Application.





From the service function **Measurement/Unit** ( Page 184), specify the unit of measurement for measuring the ferrite contents of an Application that is to be set up.



Once the linking mode is enabled (indicated by: **3-3-E** on the LCD display), an automatic check will be carried out to see, whether one or more Applications have already been set up with the connected probe. If this is the case, no normalization is required when setting up the Application. Instead, the normalization and corrective calibration of the Application(s) that has/have been set up with this probe will be used.

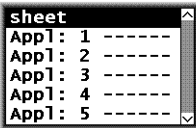

As long as the restricted operating mode is enabled (indicated by  on the LCD display), only Applications that have already been set up can be selected, i.e., it is not possible to set up new Applications ( 10.6.1 'Restricted Operating Mode', beginning on Page 171).

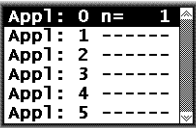
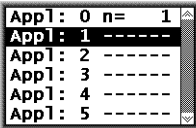
Procedure

Key sequ. / Action	Detail of the LCD display	Explanation
APPL No		<p>Use APPL No to start the selection of the Application.</p> <p>[Appl:]: Application number</p> <p>[sheet:]: Assigned Application designation (Example; appears only if an Application designation has been assigned ( 5.5 'Assigning Application Designations', beginning on Page 52). If an Application designation has not been assigned, the following will appear immediately on the LCD display:</p>
APPL No		<p>Use APPL No to start or continue the selection of the Application.</p> <p>[Appl:]: Application number</p> <p>[n=]: Number of the measurements stored in the Application</p>
^ or v		<p>Use the arrow keys to select an Application that has not yet been set up.</p>

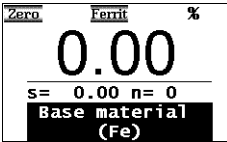
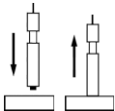
Key sequ. / Action	Detail of the LCD display	Explanation
ENTER	<div style="text-align: center;">Unit </div> <div style="text-align: center;">Unit </div>	<p>if [always ask] is selected from the service function Measurement/Unit (☰ 10.7.5 'Unit', beginning on Page 184), select the unit of measurement for making the measurements in the Application at this point:</p> <p>Use the arrow keys to select the unit.</p> <p>[Fe%]: The ferrite content will be measured in ferrite percent.</p> <p>[FN]: The ferrite content will be measured in ferrite numbers.</p> <p>[OK: ENTER]: Use ENTER to confirm the selection.</p>
ENTER		<p>Use ENTER to start setting up the Application.</p> <p>ZERO appears on the LCD display.</p> <p>[Base material (Fe)]: The measurements for the normalization should be made on base.</p> <p>ENTER: Cancels the normalization.</p>
		<p>Performing the normalization: ☰ beginning on Page 68.</p>

5.2 Selecting the Desired Application

To make ferrite content measurements, a probe must be connected and an Application must be selected that has been set up using the connected probe before measurements can be made.



If [Ferrite] flashes on the LCD Display after instrument power-up or after selecting an Application, an Application has not yet been set up using the connected probe. It is not possible to make measurements when the display is flashing.

The following options exist if an Application has not yet been set up using the connected probe:

- Setting up a new Application using the connected probe (☰ 5.1 ‘Setting Up an Application’, beginning on Page 45),
- Overwriting an existing Application using the connected probe (☰ 5.3 ‘Deleting an Application’, beginning on Page 49),
- Connecting a probe that has already been used to set up an Application (☰ 3.2 ‘Connecting Probes’, beginning on Page 33).

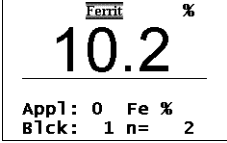

Procedure Selecting an Application

Key sequ. / Action	Detail of the LCD display	Explanation
APPL No	<pre> App1: 0 n= 1 App1: 1 n= 2 App1: 2 ----- App1: 3 ----- App1: 4 ----- App1: 5 ----- </pre>	<p>Use APPL No to start the selection of the Application.</p> <p>[Appl:]: Application number [n=]: Number of the measurements stored in the Application</p>
^ or v	<pre> App1: 0 n= 1 App1: 1 n= 2 App1: 2 ----- App1: 3 ----- App1: 4 ----- App1: 5 ----- </pre>	<p>Use the arrow keys to select the desired Application.</p>

Key sequ. / Action	Detail of the LCD display	Explanation
ENTER		Use ENTER to confirm the selected Application. The selected Application will be retrieved. The last reading of the last not closed block is displayed. The instrument is ready to make measurements.

5.3 Deleting an Application





As long as the restricted operating mode is enabled (indicated by  on the LCD display), the **DEL** key will not be enabled, i.e., it is not possible to delete Applications ( 10.6.1 'Restricted Operating Mode', beginning on Page 171).



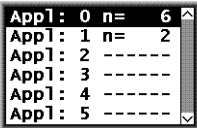
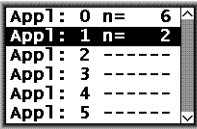

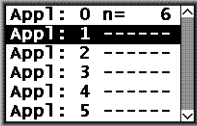

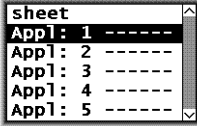

When deleting an Application, all readings as well as the normalization and corrective calibration coefficients stored in the Application will be deleted. Thus, this Application memory is free for a new measuring application.

Key sequ. / Action	Detail of the LCD display	Explanation
APPL No		Use APPL No to start the selection of the Application. [App1:] : Application number [n=] : Number of the measurements stored in the Application
^ or v		Use the arrow keys to select the Application to be deleted or leaf through the pages using CAL + v .

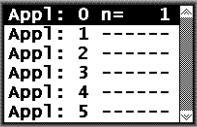
Key sequ. / Action	Detail of the LCD display	Explanation
DEL		<p>Use DEL to start the deletion process. Pressing DEL again: Deletes the Application.</p> <p>ENTER: Cancels the deletion.</p>
		<p>It is now possible to select a different Application ( Page 48) or to set up a new Application ( Page 45).</p>

5.4 List of Set Up Applications

Key sequ. / Action	Detail of the LCD display	Explanation
APPL No		<p>Use APPL No to start the selection of the Application.</p> <p>[sheet]: Assigned Application designation (Example; appears only if an Application designation has been assigned ( 5.5 'Assigning Application Designations', beginning on Page 52). If an Application designation has not been assigned, the following will appear immediately on the LCD display:</p>
		<p>[Appl:]: Application number</p> <p>[n=]: Number of the measurements stored in the Application</p>

Key sequ. / Action	Detail of the LCD display	Explanation
Print		<p>Use PRINT to start the printout of the list of set up Applications.</p> <p>The list of set up applications will print if a printer is connected and switched on ( Fig. 5-1).</p> <p>It is now possible to select a different Application ( Page 48) or to set up a new Application ( Page 45).</p>

FISCHER FERITSCOPE FMP30	23.07.08
Applications:	
0 sheet	
FGAB1.3Fe Fe %	23.07.08 n= 7
1 face	
FGAB1.3Fe Fe %	n= 3
2 level	
FGAB1.3Fe Fe %	n= 0

Fig. 5-1 List of set up Applications (Example)

Explanations to Fig. 5-1:

FISCHER FERITSCOPE FMP30	Instrument type:
2008-07-23	Current date
0, 1, 2 (1st column)	Number of the Application
sheet, face ...	Application designation (appears only if an Application designation has been assigned ( Page 52).
FGAB1.3Fe ...	Short form designation for the probe that has been used to set up the Application.
Fe% ...	Unit (Fe% or FN)

2008-07-23	End of block - Date of the last block closure of this Application (if no date is shown, the Application does not contain a closed block!).
n=	Number of measurements stored in this Application

5.5 Assigning Application Designations

A customer-specific designation that can be comprised of a max. of 16 ASCII characters can be assigned to every Application.

Assigning the Application designation can be carried out in the following manner:

- Use of the optional software MPNAME (the software is available from your authorized supplier or directly from the Helmut Fischer GmbH Institute for Electronics and Metrology.)
- Transmitting the command “SAN” via the USB port ( 9.4.2 ‘Control Commands’, beginning on Page 142)



When making measurements in the matrix measuring mode, each block can be assigned a designation as well ( Page 115).









Once Application or block designations have been assigned, the designations appear in the information lines of the LCD display, where applicable, alternating with the respective numbers. On print-outs, the Application or block designation will appear **in place** of the Application or block number.

5.6 Application Specific Settings

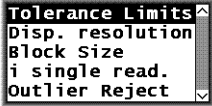

The following settings apply only to the settings of the open Application, i.e., they are Application-specific:

- Settings that are entered after pressing the **MENU** key.
- Measurement program ( Page 61)
- Unit ( Page 184)

After pressing the **MENU** key, the following application-specific settings can be made:

Key sequ. / Action	Detail of the LCD display	Explanation
MENU		<p>Selects a menu option by pressing \wedge or \vee:</p> <ul style="list-style-type: none"> ● Tolerance Limits ( Page 54) ● Measurement display resolution ( Page 56) ● Automatic block size and block creation ( Page 57) ● Number of single readings to be measured in auto-averaging mode before an individual value is generated from them by averaging ( Page 58) ● Outlier rejection ( Page 60) <p>Pressing ENTER confirms the selection. Pressing DEL or performing a measurement exits the MENU.</p>







As long as the restricted operating mode is enabled (indicated by  on the LCD display), the **MENU** key will not be enabled, i.e., it is not possible to modify these application-specific settings ( 10.6.1 'Restricted Operating Mode', beginning on Page 171)!

5.6.1 Tolerance Limits

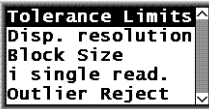
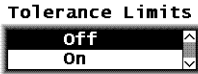
Having the tolerance limits enabled allows for a simple and quick determination if the measured ferrite contents are within specified limits

(☰ 7.3.5 ‘Measurements With Tolerance Limits Enabled’, beginning on Page 94).

Key sequ. / Action	Detail of the LCD display	Explanation
MENU		Use MENU to start Settings.
ENTER		Use ENTER to confirm the “tolerance limits”.
^ or v		To activate the tolerance limits: use the arrow keys to select limits “on” or to deactivate the tolerance limits: Select limits “off”.
ENTER		Use ENTER to confirm the value for the lower specification limit or: specify a new lower limit by pressing ^ or v.
ENTER ^ or v		Use ENTER to confirm the value for the upper specification limit or: specify a new upper limit by pressing ^ or v.
	It is also possible to set the upper and lower specification limits by making a measurement on an object that corresponds approximately to the specification limits to be set.	

ENTER

Press **ENTER** to confirm the entry. The tolerance limits are now set and enabled. Press **DEL** to return to the measurement screen. The instrument is ready to make measurements.



As long as the tolerance limits are enabled,  will appear on the LCD display.

If the upper and lower specification limits are mixed up when entering the settings, the instrument will automatically select the lower values as the lower specification limit and the higher value as the upper specification limit.

5.6.2 Measurement Display Resolution

The measurement display resolution specifies the resolution for displaying the readings on the LCD display.

Example: Reading **18.61**

Display with resolution setting “low”: **19**

Display with resolution setting “standard”: **18.6**

Display with resolution setting “high”: **18.61**

Resolution	0.0 ...0.999	1.0 ...9.99	10 ...99.99	100 ...999.9	1000 ...9999
low	0.9	9.9	99	999	9999
medium	0.99	9.9	99.9	999	9999
high	999	9.99	99.99	999.9	9999

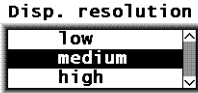



Key sequ. / Action	Detail of the LCD display	Explanation
MENU ∨		Use MENU to start Settings and select “Disp. resolution” using the arrow key ∨ .
ENTER ^ or ∨		Use ENTER to confirm the selection “Disp. resolution”. Use the arrow keys ^ or ∨ to select the desired resolution.
ENTER		Press ENTER to confirm the selection and return to the menu to enter additional settings. Press DEL to return to the measurement screen. The instrument is ready to make measurements.

5.6.3 Automatic Block Size and Block Creation

“Automatic block creation” must be enabled and a block size must be defined for a certain number of readings to be combined in a block automatically during the measurement. The block size must be between 2 and 99 ( 7.3.6 ‘Measurements With a Fixed Block Size’, beginning on Page 94).

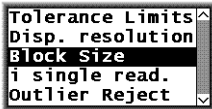
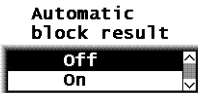

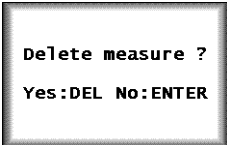
Automatic block creation is not available in the matrix measuring mode.



Key sequ. / Action	Detail of the LCD display	Explanation
MENU ∨		Use MENU to start Settings. Press the arrow key ∨, until “Block size” is highlighted.
ENTER		Use ENTER to confirm the selection “Block size”.
∧ or ∨		To activate “Block size”: Use the arrow keys to select Automatic block result “on” or to deactivate block size: select Automatic block result “off”.
Enter		Press DEL to delete the readings of the open Application. If measurements have already been made without a fixed block size, these measurements must be deleted because the subsequent statistical evaluation of the blocks is correct only if the number of readings is the same for each block. When pressing ENTER , the fixed block size mode will not be enabled.
∧ or ∨		Use the arrow keys to set the desired block size.



Key sequ. / Action	Detail of the LCD display	Explanation
ENTER		Press ENTER to confirm the selection and return to the menu to enter additional settings. Press DEL to return to the measurement screen. The instrument is ready to make measurements.

The block size can be modified even if automatic block creation has already been enabled. However, the prompt for deleting previously made measurements will appear again because the subsequent statistical evaluation does not permit blocks containing different numbers of readings.

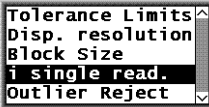
5.6.4 Auto-Averaging Mode

With measurements made in auto-averaging mode, the mean value generated from a number of single readings is stored in place of the single readings. The number of single readings must be between 2 and 20 (see 7.3.7 ‘Measurements in Auto-Averaging Mode’, beginning on Page 96).

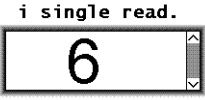

Key sequ. / Action	Detail of the LCD display	Explanation
MENU ∨		Use MENU to start Settings. Press the arrow key ∨, until “i single read.” is highlighted on the LCD display.
ENTER		Use ENTER to confirm the selection “i single read.”.
∧ or ∨		To activate the auto-averaging mode: use the arrow keys to select i single read. “on” or to deactivate the auto-averaging mode: select i single read. “off”. Use ENTER to confirm the selection.







Key sequ. / Action	Detail of the LCD display	Explanation
Enter ^ or v		Use Enter to confirm the value for the number of single readings or: specify a new value by pressing the arrow keys ^ or v.
ENTER		If the "i" value is modified during a test series, all readings obtained before must be deleted. Press ENTER to return to the menu to enter additional settings. Press DEL to delete all readings of the open Application.
ENTER		Press ENTER to confirm the selection and return to the menu to enter additional settings. Press DEL to cancel the procedure.
	If the "i" value is modified during a test series, the prompt to delete all readings obtained before will appear here as well - for statistical reasons. If this is not carried out, it will not be possible to modify the "i" value.	

5.6.5 Outlier rejection

With outlier rejection enabled, recognized outliers will be indicated on the LCD display and announced through an audible signal ( 7.3.8 ‘Measurements With Outlier Rejection Enabled’, beginning on Page 97).

The following methods are available for the outlier rejection function:

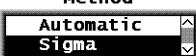
- Grubbs Test ( Glossary)
- Specification of a known spread (Sigma) ( Glossary)

Key sequ. / Action	Detail of the LCD display	Explanation
MENU ∨		Use MENU to start Settings. Press the arrow key ∨, until “Outlier Reject” is highlighted on the LCD display.
ENTER		Use ENTER to confirm the selection “Outlier Reject”.
∧ or ∨		To activate outlier rejection: use the arrow keys to select Outlier Reject “on” or to deactivate outlier rejection: Select Outlier Reject “off”.
Enter		Use ENTER to confirm the method “Automatic”. or:
∨		Press the arrow key ∨ to specify the method “Sigma”.
		Press the arrow keys to set the desired Sigma value.

Key sequ. / Action	Detail of the LCD display	Explanation
ENTER		<p>Press ENTER to confirm the selection/entry and return to the menu to enter additional settings.</p> <p>Press DEL to return to the measurement screen.</p> <p>The instrument is ready to make measurements.</p>

5.6.6 Measured Variables

The readings will be displayed on the LCD screen corresponding to the set measured variables.

The following measured variables can be set from the Service function (☰ 10.7.6 ‘Measured Variable’, beginning on Page 185):

- Fe % or FN (display of the ferrite content in ferrite percent or in ferrite numbers),
- normalized countrate X
- Countrate X
- Fe % / FN and Xs
- Xn and Xs

Explanation of the measured variables: ☰ Glossary



The measured variable can be set differently in each Application. The settings of the measured variables of the other Applications will not be affected.

With every modification of the measured variable, a prompt for deleting readings already stored in the open Application will appear because it is not possible to evaluate different types of measured variables statistically. This prevents erroneous interpretations of the measurement results.

Measurement program	Detail of the LCD display	Explanation
Ferrite content % or FN	<p>Ferrite % 10.2 App1: 0 Fe % Blck: 1 n= 2</p>	Ferrite content display in [%]: Ferrite percent
	<p>Ferrite FN 10.5 App1: 0 FN Blck: 1 n= 1</p>	[FN]: Ferrite numbers The ferrite content will be displayed in Fe% or FN corresponding to the set unit (☰ 10.7.5).
norm. countrate	<p>Ferrite .8136 App1: 0 Blck: 1 n= 2</p>	Displays the normalized countrate Xn of the measured value.
Countrate	<p>Ferrite 25469 App1: 0 Blck: 1 n= 2</p>	Displays the countrate X of the measured value.
Fe % / FN and Xs	<p>Ferrite % 10.3 Xs 22861 App1: 0 Fe % Blck: 1 n= 1</p>	Display of ferrite content and saturation countrate Xs (countrate for probe in air). The ferrite content will be displayed in % or FN corresponding to the set unit (☰ 10.7.5).
	<p>Ferrite FN 10.5 Xs 22861 App1: 0 FN Blck: 1 n= 2</p>	
Xn and Xs	<p>Ferrite 0.8133 Xs 22861 App1: 0 Blck: 1 n= 2</p>	Displays the normalized countrate Xn of the measured value and the saturation countrate Xs.

5.7 Linking Applications





( 10.6.4 ‘Linking Applications’, beginning on Page 177)

If the linking mode is enabled, all applications that have set up using the same probe (identified by the same serial number) will be linked with each other. Applications that have been linked to each use the same normalization and/or corrective calibration to determine measurements.

Example:

If a separate Application has been set up for each batch of a component (using the same probe each time), it is useful to link the Applications to each other in order to compare the Applications to each other. Because these are the same kind of components, only from different batches, the same normalization and/or corrective calibration should be used every time.

5.7.1 Application Linking Procedure

- 1.** Enable the instrument function “Linking mode” ( 10.6.4 ‘Linking Applications’, beginning on Page 177).
- 2.** Perform a normalization to set up all Applications to be linked. The measurement probe is assigned to the Application ( 5.1 ‘Setting Up an Application’, beginning on Page 45).
- 3.** Perform a careful normalization or calibration on a typical uncoated component ( 6.2 ‘Normalization’, beginning on Page 68 and  6.3 ‘Corrective Calibration’, beginning on Page 71).
This as well as all subsequent normalizations or calibrations will be applied o all linked Applications; the normalization stored when setting up the respective Application will be overwritten.



Applications that have been set up with different probes of the same probe model (indicated by the same model designation but different serial numbers) will not be linked.

5.7.2 Enabling and Disabling the Linking Mode

The linking mode is enabled or disabled from the Service functions of the instrument (10.6.4 'Linking Applications', beginning on Page 177).



As long as the linking mode is enabled ~~3-3-E~~ will appear on the LCD display.



After disabling the linking mode, all Applications will again be independent of each other!
Each Application can again be normalized and/or calibrated separately.

5.7.3 Example for Linked Applications

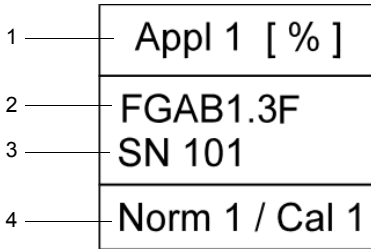

Fig. 5-2 Explanation to Fig. 5-3

1 .. Appl 1: Application number [%]: Readings are shown in ferrite percent	3 .. Serial number of the probe
2 .. Probe model of the probe that has been used to set up this Application	4 .. Norm1: Normalization 1 Cal 1 Corrective calibration 1

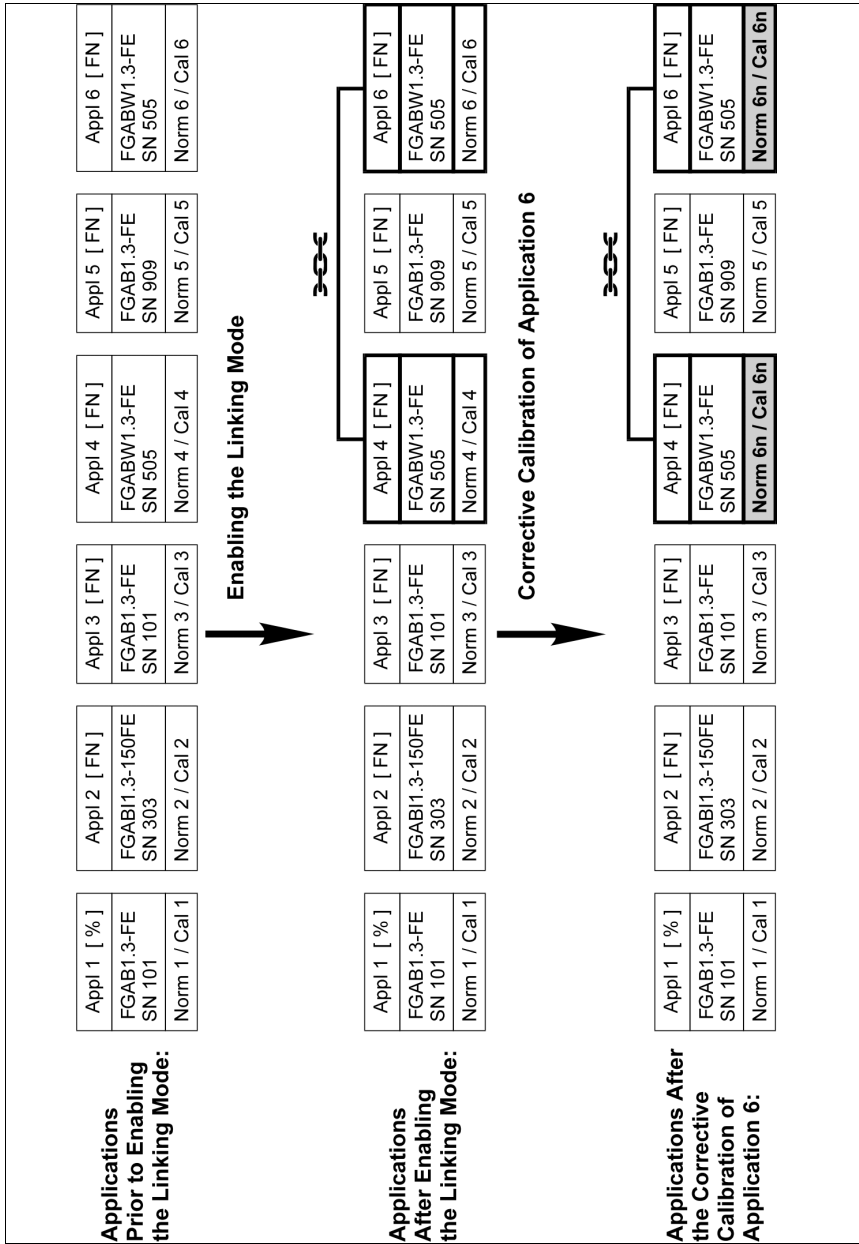

Fig. 5-3 Example for linking of applications

Immediately following the linking procedure:

Because a normalization or a corrective calibration has not yet been carried out immediately following the linking procedure, the normalizations and corrective calibrations of the linked Applications still differ from each other.

- Applications 4 and 6 are also linked to each other ~~3-0-E~~, because they have been set up with the same FGABW1.3-FE probe (serial number 505).
- Even though Applications 1 and 3 have been set up with the same FGAB1.3-FE probe (serial number 101), they are not linked to each other because the readings in Application 1 are displayed in ferrite percent [%] and the readings in Application 3 in ferrite numbers [FN].
- Application 5 is not linked to these two Applications because it has been set up with the FGAB1.3-FE probe with the serial number 909.
- Application 2 is not linked to any other Application because no other Application has been set up with the FGABI1.3_150FE probe (serial number 303).

After the corrective calibration of Application 6:

- Because Applications 4 and 6 are linked with each other, after the corrective calibration of Application 6, the new corrective calibration (Norm 6n, Cal 6n, grayed out in Fig. 5-3) will be stored in Application 4 as well. The previous normalization and corrective calibration (Norm 4/6 and Cal 4/6) will be overwritten.



The normalization and corrective calibration of all other Applications remains unchanged in spite of linking, because a normalization or corrective calibration has not yet been carried out with these probes.

6 Normalization, Calibration and Master Calibration

The following factors influence the readings of a ferrite content measurement:



- Geometry of the specimen (size of the reference area, curvature, distance of the measurement location from the edge of the specimen, sheet thickness, cladding thickness)

The correction of these influencing quantities should be carried out based on the correction factors listed  beginning on Page 116.







Creating user-specific calibration standards to determine, for example the influence of the curvature or thickness of the specimen is not recommended because the ferrite content of the starting material can be altered even with most careful mechanical processing, especially in the surface area that is registered by the probe.

- Probe tip wear

To a certain degree, probe tip wear can be corrected through a corrective calibration ( beginning on Page 71) or even better, through a master calibration ( beginning on Page 77). Too much probe tip wear, which becomes noticeable through an increased scatter of the readings on a specimen with a homogeneous ferrite content distribution (e.g., a calibration standard), cannot be corrected. In such a case, the probe must be sent to your authorized distributor or directly to the Helmut Fischer GmbH Institute for Electronics and Metrology for repair.

6.1 Information Regarding Normalization, Calibration and Master Calibration

- The information in Chapter ““1 ‘Important Information’, beginning on Page 9“should be observed with every normalization, calibration and master calibration!
- All measurements should be performed with great care! Only in this manner can the trueness specified for the used probe be ensured during the subsequent measurements.

- Reference measurements should be performed after every normalization and calibration to verify the normalization and calibration.
- It is not possible to start a normalization, corrective calibration or a master calibration as long as the restricted operating mode is enabled (indicated by  on the LCD display) ( 10.6.1 ‘Restricted Operating Mode’, beginning on Page 171)!
- A new block starts automatically after every normalization or calibration. The measurements stored in the Applications will **not** be deleted after a normalization or calibration. If required, these measurements may need to be deleted prior to the next measurement.
- The normalization and corrective calibration affects only the open Application. The other applications are not affected. The coefficients of the master characteristic stored in the EEPROM of the probe plug are also not affected. However, if the linking mode is enabled ( on the LCD display), the normalization and the corrective calibration affect **all** Applications that are linked with the open Application.
- With external start enabled, a measurement acquisition can be triggered during a normalization or calibration by:
 - Pressing the **FINAL-RES** key,
 - Transmitting one of the ASCII characters “**G0**”, “**ES**”, “**EN**” or
 - the control character “**ESC?**” via the USB port (ESC = ASCII27).
 Enabling externally triggered measurement acquisition: ( 10.7.3 ‘External Start’, beginning on Page 180;  9.4.2 ‘Control Commands’, beginning on Page 142



6.2 Normalization

With the normalization, a new zero point is established for the calibration curve of the open Application and stored in the open Application. The coefficients of the master characteristic stored in the EEPROM of the probe plug are not affected.

Required materials

Base from the calibration standard set

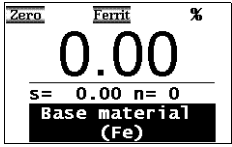
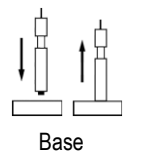
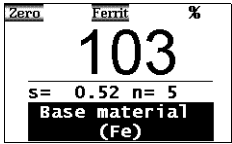
6.2.1 Normalization Procedure

Key sequ. / Action	Detail of the LCD display	Explanation
ZERO		<p>Use ZERO to start the normalization of the open Application. ZERO appears and remains on the LCD display while the normalization is performed.</p> <p>[s]: Standard deviation [n]: Number of measurements</p> <p>[Base material (Fe)]: The measurements should be made on the base material of the calibration standard set.</p> <p>[Cancel: ENTER]: Using ENTER cancels the normalization.</p>
 <p>Base</p>		<p>Make about 5 measurements at different locations of the base.</p> <p>The mean value of all readings obtained for the normalization will be displayed.</p> <p>[Delete: DEL]: Use DEL to delete the last measurement DEL, 2x DEL to delete all readings obtained for the normalization. [OK: ENTER]: Using ENTER ends the normalization.</p>
ENTER		<p>A confirmation indicating that the normalization has been carried out successfully appears.</p> <p>Pressing ENTER confirms the message. PRINT: A print form of the normalization will be printed if a printer is connected and switched on ( Page 70).</p>

Key sequ. / Action	Detail of the LCD display	Explanation
ENTER	<p>The LCD display shows 'Ferrit %' at the top. Below it, there is a horizontal line. At the bottom, it displays 'App1: 0 Fe %' and 'Blck: 1 n= 0'.</p>	<p>The new characteristic will be computed automatically and stored. The instrument is again ready to make measurements. ()2.1 'LCD-Display', beginning on Page 16.</p>

- To verify a correct normalization, perform several reference measurements on certified calibration standards. A corrective calibration must be performed if the mean values obtained from several single readings are not within the guaranteed error limit stated on the calibration standards.

6.2.2 Documenting the Normalization with a Printer

FISCHER FERITSCOPE FMP30	23.07.08
NORMALIZATION	23.07.08 12:38
Appl.No.: 3	Probe: FGAB1.3Fe
Fe	
fe.= 98.86 Fe%	s= 0.321 Fe%

Fig. 6-1 Print form of a normalization (example)

Explanations to Fig. 6-1:

FISCHER FERITSCOPE FMP30	Instrument type:
2008-07-23	Current date
NORMALIZATION	Normalization will be documented
Date Time	Date and time of the normalization
Appl. No.	Number of the Application
Probe	Probe that has been used to perform the normalization
Fe	Applied measurement method
fe.	Mean value of all readings obtained for the normalization.
s	Standard deviation of the readings obtained for the normalization.

6.3 Corrective Calibration

With a corrective calibration, a new zero point and one additional point (one-point calibration with one calibration standard) or two additional points (two-point calibration with two calibration standards) are established for the calibration curve of the open Application and are stored in the open Application. The coefficients of the master characteristic stored in the **EEPROM** of the probe plug are not affected.

Required materials

- Suitable calibration standard set for the corrective calibration (in the desired measurement range)



6.3.1 Selecting the Calibration Standards for the Corrective Calibration

Calibration standards are suitable for corrective calibrations only if their normalized countrates X_n are between the following X_n ranges:



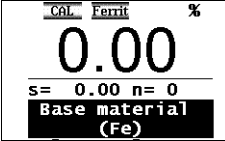

- The normalized countrate X_n of the first calibration standard must be between 0.02 and 0.9 ($0.02 \leq X_n \text{ calibration standard } 1 \leq 0.9$).
- The normalized countrate of the second calibration standard (for a two-point calibration) must be between 0.12 and 0.98 ($0.12 < X_n \text{ calibration standard } 2 \leq 0.98$).
- The difference of the normalized countrates of the two calibration standards that are used for the two-point calibration must be greater than 0.1 ($X_n \text{ calibration standard } 2 - X_n \text{ calibration standard } 1 = \Delta X_n > 0,1$).

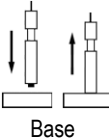
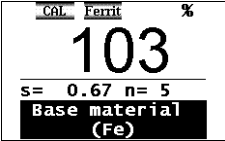
Determination of the countrate X_n :  Page 85.

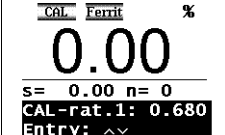
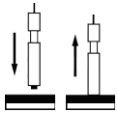
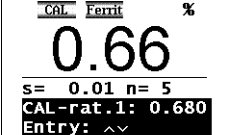
6.3.2 Corrective Calibration Procedure

Key sequ. / Action	Detail of the LCD display	Explanation
<p>CAL</p>		<p>Use CAL to start the corrective calibration of the open Application. CAL appears and remains on the LCD display while the corrective calibration is performed.</p> <p>[s]: Standard deviation [n]: Number of measurements</p> <p>[Base material (Fe)]: The measurements should be made on base. [Delete cal: DEL]: Using DEL deletes the corrective calibration ( Page 75). [Skip: ENTER]: Using ENTER skips the normalization (the stored normalization is retained unchanged). [Cancel: CAL]: Using CAL cancels the corrective calibration (the stored corrective calibration is retained unchanged).</p>
 <p>Base</p>		<p>Make about 5 measurements at different locations of the base.</p> <p>[Delete: DEL]: Use DEL to delete the last measurement DEL, 2x DEL to delete all readings obtained for the normalization. [Cancel: CAL]: Using CAL cancels the corrective calibration (the stored corrective calibration is retained unchanged). [OK: ENTER]: Use ENTER to end and store the normalization.</p>

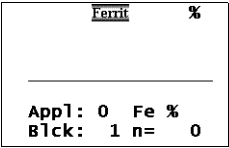
Key sequ. / Action	Detail of the LCD display	Explanation
ENTER		<p>[Entry: ^v]: Use the arrow keys to set the rated ferrite content value of the calibration standard.</p> <p>The rated value can be set faster if a measurement is performed on a calibration standard that is within the tolerance range, and then the rated value is corrected using the arrow keys.</p> <p>[CAL-rat. 1: 0.680]: Display of the set rated value for the ferrite content of the calibration standard (Example: 0.680 Fe%)</p> <p>[Cancel: ENTER]: Using ENTER cancels the calibration procedure</p>
 Calibration standard		<p>Make about 5 measurements at different locations of the calibration standard. Displayed is the mean value of all measurements performed for this step.</p> <p>[Delete: DEL]: Use DEL to delete the last measurement DEL, 2x DEL to delete all readings obtained for the calibration.</p> <p>[OK: ENTER]: Use ENTER to end the current calibration step.</p>
ENTER		<p>If a corrective calibration is desired with 2 or 3 standards, proceed in the same manner with calibration standards 2 and 3. Otherwise: Use ENTER to end the corrective calibration.</p> <p>The new characteristic will be computed automatically and stored.</p> <p>The instrument is again ready to make measurements.</p>

Key sequ. / Action	Detail of the LCD display	Explanation
ENTER		<p>A confirmation indicating that the corrective calibration has been carried out successfully appears.</p> <p>Pressing ENTER confirms the message.</p> <p>PRINT: A print form of the corrective calibration will be printed if a printer is connected and switched on ( Page 76).</p>
ENTER		<p>The new characteristic will be computed automatically and stored. The instrument is again ready to make measurements. ()2.1 'LCD-Display', beginning on Page 16.</p>

- To verify a correct calibration, perform several reference measurements on certified calibration standards. The corrective calibration must be repeated if the mean values obtained from several single readings are not within the guaranteed error limit stated on the calibration standards, or if the deviations are unacceptable again, a master calibration must be performed.

6.3.3 Deleting a Corrective Calibration



When deleting the corrective calibration, only the corrective calibration of the open Application will be deleted. The corrective calibrations of the other Applications are retained. However, if the linking mode is enabled (~~3-3-E~~ on the LCD display), the corrective calibrations of all Applications that are linked with the open Application will be deleted.

Key sequ. / Action	Detail of the LCD display	Explanation
CAL		<p>Use CAL to start the corrective calibration of the open Application.</p> <p>[Delete cal: DEL]: Using DEL deletes the corrective calibration.</p> <p>[Cancel: CAL]: Using CAL cancels the corrective calibration (the stored corrective calibration is retained unchanged).</p>
DEL		<p>[Yes: DEL]: The corrective calibration will be deleted.</p> <p>[No: ENTER]: Cancels the delete procedure.</p>
DEL		<p>The corrective calibration will be deleted. The instrument is again ready to make measurements.</p>

6.3.4 Documenting the Corrective Calibration with a Printer

FISCHER FERITSCOPE FMP30		23.07.08	
CALIBRATION		23.07.08	12:43
Appl.No.: 3 Probe:FGAB1.3Fe			
Fe			
fe.= 104.2 Fe%	s= 1.671 Fe%	Measurements on Base	
Fe: 0.680 Fe%			
fe.= 0.646 Fe%	s= 0.010 Fe%	Measurements on Calibration standard # 1	
Fe: 3.08 Fe%			
fe.= 3.054 Fe%	s= 0.038 Fe%	Measurements on Calibration standard # 2	
Fe: 10.90 Fe%			
fe.= 10.35 Fe%	s= 0.014 Fe%	Measurements on Calibration standard # 3	

Fig. 6-1 Print form of a corrective calibration (example)

Explanations to Fig. 6-1:

FISCHER FERITSCOPE FMP30	Instrument type:
2008-07-23	Current date
CALIBRATION	Corrective calibration is being documented
Date Time	Date and time of the corrective calibration
Appl. No.	Number of the Application
Probe	Probe that has been used to perform the calibration
Fe	Applied measurement method
Fe:	Confirmed rated value for the ferrite content of the calibration standards.
fe.	Mean value of all readings obtained for this step of the calibration.
s	Standard deviation of the readings obtained for this step of the calibration.

6.4 Master Calibration

The master calibration determines the coefficients of the master characteristic and stores them in the EEPROM of the probe plug. These coefficients determine the master characteristic, i.e., the correlation between the measurement signal of the probe and the ferrite content.

The EEPROM of the probe plug includes memories for the coefficients of two master calibrations. These two master calibrations differ in the following manner:

Factory master calibration

One master calibration (factory master calibration) is performed at the facility of the Helmut Fischer GmbH Institute for Electronics and Metrology with a very high precision using 5 calibration standards (incl. 1 base). It cannot be deleted or overwritten by the user.

User Master Calibration

You can set up the user master calibration by yourself using 5 calibration standards. This memory is empty when a new probe is supplied. Once the user has set up his “own” master calibration in the manner described below, he can overwrite or even delete this calibration, if needed.

5 calibration standards are required to set up a user master calibration. They are part of the optional probe-specific master calibration standard set. The X_n values of one of these calibration standards must be within the prescribed X_n range of the master calibration for all 4 X_n ranges to be “occupied”.

To increase the measuring precision in a certain measurement interval of the probe, up to 4 additional calibration standards with ferrite contents in this interval can be used. This means that max. 5 calibration standards can be in an X_n range of the user master calibration.

If the user master calibration is deleted and a new one is not set up, the factory master calibration will be used automatically to make measurements.



After setting up or deleting a user master calibration, all corrective calibrations that have been set up with the respective probe will be deleted. This means that after deleting the user master calibration and continued measurements using the factory master calibration, a new corrective calibration should be performed for each Application, if necessary.

6.4.1 Selecting the Calibration Standards



For the user master calibration, the master calibration standard set available from the Helmut Fischer GmbH Institute for Electronics and Metrology as an option should be used! Only in this manner can the specified trueness be ensured during the subsequent measurements.

During the user master calibration, the master characteristic can be determined only if suitable calibration standards are used. If the master calibration standards of the Helmut Fischer GmbH Institute for Electronics and Metrology are not used, the normalized countrates X_n of the master calibration standards used in their place must be within the specific X_n ranges. The X_n values can be displayed after the 1st step of the user master calibration (normalization)

( 6.4.4 'Displaying X_n Ranges for Calibration Standards for the Master Calibration', beginning on Page 83).

6.4.2 Performing a User Master Calibration



A user master calibration (hereafter simply referred to as a master calibration) must be performed only by experienced users.

- The master calibration applies to all Applications that have been set up with the same probe that has been used for the master calibration (because the coefficients have been stored in the probe plug of the EEPROM)! This applies to both an enabled and a disabled linking mode.
- After a master calibration is completed, the normalizations and corrective calibrations of all Applications that have been set up with the same probe that has been used for the master calibration will be deleted automatically.

Required materials

- Calibration standard set of the Helmut Fischer GmbH Institute for Electronics and Metrology or
- other suitable certified standards

6.4.3 Master Calibration Procedure



The probe tip should be checked for potential wear prior to a master calibration.

Too much probe tip wear becomes noticeable through an increased scatter of the readings on a specimen with a homogeneous ferrite content distribution (e.g., a calibration standard).

In such a case, the probe must be sent to your authorized distributor or directly to the Helmut Fischer GmbH Institute for Electronics and Metrology for repair.



During the master calibration, the master characteristic can be determined only if suitable calibration standards are used.

The calibration standards are suited for the master calibration only if their normalized countrates X_n are within pre-established X_n ranges.

The limits of the X_n ranges can be queried during the master calibration without affecting the calibration.

The master calibration is retrieved from the service function menu (📖 10.9 ‘Performing a Master Calibration’, beginning on Page 187).

Key sequ. / Action	Detail of the LCD display	Explanation
5 x ENTER	<pre> System Evaluation USB Print Device Mode Measurement Storage mode Master calibration About... </pre>	Press ENTER 5 times to retrieve the “Service Function” menu and set the identification number 159 of the service functions using the arrow keys \wedge . Retrieve the master calibration from the Service functions menu and use ENTER to start the procedure.
2 x \wedge		

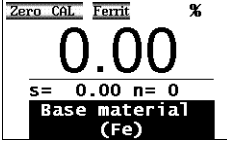
Key sequ. / Action	Detail of the LCD display	Explanation
ENTER		<p>ZERO + CAL appear and remain on the LCD display while the master calibration is performed.</p> <p>[s]: Standard deviation [n]: Number of measurements</p> <p>[Base material (Fe)]: The measurements (normalization) should be made on base.</p> <p>[MCL Delete: DEL]: Use DEL to delete an existing master calibration (appears only if a master calibration has already been performed). Use CAL if you do not wish to delete the master calibration.</p> <p>[Cancel: CAL]: Use CAL to cancel the master calibration.</p>

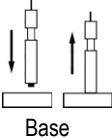
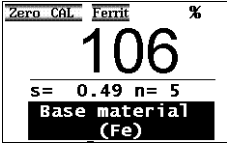

If you press **DEL** again after deleting the master calibration in order to exit the menu, subsequent measurements will be made with the factory master calibration - without a corrective calibration.

Key sequ. / Action	Detail of the LCD display	Explanation
		<p>Make about 5 measurements at different locations of the base.</p> <p>The mean value of all readings obtained for the normalization will be displayed.</p> <p>[Base material (Fe)]: The measurements should be made on base.</p> <p>[Delete: DEL]: Use DEL to delete the last measurement DEL, 2x DEL to delete all readings obtained for the normalization.</p> <p>[OK: ENTER]: Use ENTER to end and store the normalization. The previous normalization will be overwritten.</p>

Key sequ. / Action	Detail of the LCD display	Explanation
--------------------	---------------------------	-------------

ENTER

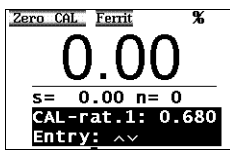

[Entry: ^v]: Use the arrow keys to set the rated ferrite content value of the calibration standard.

The rated value can be set faster if a measurement is performed on the calibration standard and then the rated value is corrected using the arrow keys.

[CAL-rat. 1: 680]: Display of the set rated value for the ferrite content of the calibration standard (Example: 0.680 Fe%)

[Cancel: ENTER]: Using ENTER cancels the calibration procedure

Pressing **FINAL-RES:**
Determination of the Normalized Countrate Xn of a Calibration Standard During a Master Calibration Page 85.

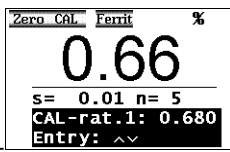
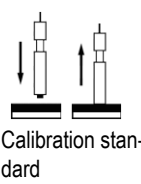

Pressing **BLOCK-RES:**
Displaying Xn Ranges for Calibration Standards for the Master Calibration Page 83.



Make about 5 measurements at different locations of the calibration standard.

[Delete: DEL]: Use DEL to delete the last measurement DEL, 2x DEL to delete all readings obtained for the normalization.

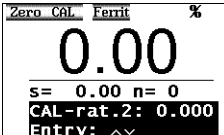
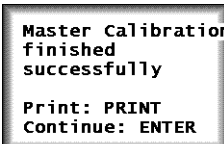
[OK: ENTER]: Use ENTER to end and store the calibration step.

Key sequ. / Action	Detail of the LCD display	Explanation
<p>^ or v</p>		<p>Use the arrow keys ^ or v to set the rated ferrite content value of the calibration standard.</p> <p>The rated value can be set faster if a measurement is performed on the calibration standard and then the rated value is corrected using the arrow keys ^ or v.</p> <p>This step is not required if the rated value for the ferrite content coincides with the stored (displayed) value.</p> <p>[OK: ENTER]: Using ENTER ends the current calibration step.</p>
<p>ENTER</p>		<p>Proceed with calibration standard #2 in the same as described for calibration standard #1. The same for all subsequent calibration steps.</p>
<p>ENTER</p>		<p>After the last calibration step has been concluded using ENTER, the new calibration curve will be computed automatically and stored, and a confirmation indicating that the master calibration has been carried out successfully appears.</p> <p>Pressing ENTER confirms the message.</p> <p>PRINT: A print form of the master calibration will be printed if a printer is connected and switched on ( Page 84).</p>



Please note the information regarding the number of calibration standards under  6.4 on Page 77.

- To verify a correct master calibration, perform several reference measurements.

Now, it is possible to make measurements in the open Application. Delete the readings of the reference measurement before starting with the measurements on your specimens.

6.4.4 Displaying Xn Ranges for Calibration Standards for the Master Calibration

During the master calibration, the master characteristic can be determined only if suitable calibration standards are used.

The calibration standards are suited for the master calibration only if their normalized countrates Xn are within pre-established Xn ranges. They can be queried during the master calibration without affecting the calibration.

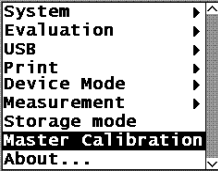
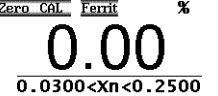
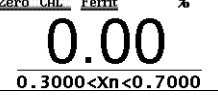
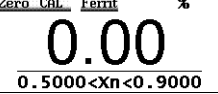
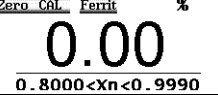
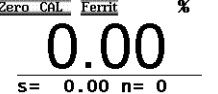
Key sequ. / Action	Detail of the LCD display	Explanation
5 x ENTER 2 x ^		Retrieve the master calibration from the Service functions menu and use ENTER to start the procedure. Relevant explanations beginning on Page 79.
BLOCK-RES		Use BLOCK-RES to display the Xn range for calibration standard #1. [0.0300<Xn<0.2500] : The normalized countrates Xn of calibration standard #1 must be within these limits of the Xn range.
BLOCK-RES		Use BLOCK-RES to display the Xn range for calibration standard #2 [0.3000<Xn<0.7000] .
BLOCK-RES		Use BLOCK-RES to display the Xn range for calibration standard #3 [0.5000<Xn<0.9000] .
BLOCK-RES		Use BLOCK-RES to display the Xn range for calibration standard #4 [0.8000<Xn<0.9900] .
BLOCK-RES		Use BLOCK-RES to end the display of the Xn range. It is now possible to continue the master calibration. Or: Press CAL + DEL to return to the measuring mode.

6.4.5 Documenting the Master Calibration with a Printer

FISCHER FERITSCOPE FMP30		23.07.08	
MASTER CALIBRATION		23.07.08	13:34
Appl.No.: 4 Probe: FGAB1.3Fe			
Fe			Measurements on uncoated specimen (base material)
fe.= 104.2 Fe%	s= 1.671 Fe%		
Fe: 0.680 Fe%			Measurements on Master calibration standard # 1
fe.= 0.646 Fe%	s= 0.010 Fe%		
Fe: 3.08 Fe%			Measurements on Master calibration standard # 2
fe.= 3.054 Fe%	s= 0.038 Fe%		
Fe: 10.90 Fe%			Measurements on Master calibration standard # 3
fe.= 10.35 Fe%	s= 0.014 Fe%		
Fe: 17.08 Fe%			Measurements on Master calibration standard # 4
fe.= 17.034 Fe%	s= 0.032 Fe%		
Fe: 23.70 Fe%			Measurements on Master calibration standard # 5
fe.= 23.63 Fe%	s= 0.014 Fe%		

Fig. 6-2 Print form of a master calibration (example)

Explanations to Fig. 6-2:

FISCHER FERITSCOPE FMP30	Instrument type:
2008-07-23	Current date
MASTER CALIBRATION	Master calibration will be documented
Date Time	Date and time of the master calibration
Appl. No.	Number of the Application
Probe	Probe that has been used to perform the calibration
Fe	Applied measurement method
Fe:	Confirmed rated value for the ferrite content of the calibration standards.

fe.	Mean value of all readings obtained for this step of the calibration.
s	Standard deviation of the readings obtained for this step of the calibration.

6.5 Determination of the Normalized Countrate Xn of a Calibration Standard During a Master Calibration

The normalized countrate Xn of a calibration standard can be determined as described below during a master calibration without affecting the calibration.



Because **FINAL-RES** triggers an externally triggered measurement acquisition if external start is enabled, is not possible to determine the normalized countrate if external start is enabled during a calibration!

Key sequ. / Action	Detail of the LCD display	Explanation
--------------------	---------------------------	-------------

FINAL-RES

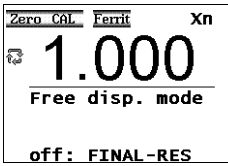

Retrieve the master calibration from the Service functions menu and use **ENTER** to start the procedure. Relevant explanations beginning on Page 79. Press **FINAL-RES** to start the procedure.

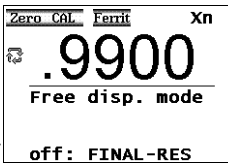
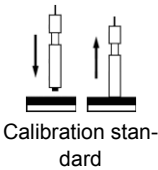

Place the probe whose normalized countrate Xn shall be determined on the calibration standard. The normalized countrate Xn of the calibration standard will be displayed (the normalized countrate will not be stored!).

FINAL-RES

[off: FINAL-RES]: Use **FINAL-RES** to return the free-running display mode to the disabled state. It is now possible to continue the calibration.

7 Measuring







The information stated in

 Chapter 1 'Important Information', beginning on Page 9 must be observed when making measurements!

7.1 Preparing for a Measurement

The instrument and the measurement area must be prepared in the following manner before measurements can be made:

- Agreement on the reference areas (determination on where several single readings are to be taken), according to DIN EN ISO 2064.
- Ensuring that the reference areas are free of interfering contaminants (e.g., moisture, dirt or grease) and are not damaged.
- Carrying Out the System Setup ( Page 29).
- Connecting a printer and if applicable switching it on (if a printer is available and a printout is desired).
- Switching on the instrument ( Page 37).
- Selecting an Application that is suitable for the specimen ( beginning on Page 45).
- Determining the instrument configuration ( beginning on Page 147).
- Determining the application-specific settings ( beginning on Page 52).
- Checking the normalization and calibration through measurements on calibration standards.

7.2 Parameters That Influence the Ferrite Content Measurement

The following factors influence the readings of a ferrite content measurement:

- Specimen curvature
- Specimen thickness
- Cladding thickness
- Edge distance of the measurement location

The influence of the specimen's shape can be corrected by multiplying the measured ferrite contents with the respective correction factors ( beginning on Page 116).

Typically, a correction of these influences is necessary only if

- the curvature diameter of a convex curvature of the specimen is less than 50 mm, or
- the curvature diameter of a concave curvature of the specimen is less than 80 mm, or
- the thickness of the specimen is less than 2 mm, or
- the cladding thickness is less than 2 mm, or
- the distance of the measurement location from the edge is less than 2 mm.



For very low ferrite contents, in particular the influence of the thickness should be determined specific to the measurement application.

7.3 Making a Measurement

To make a measurement, place the probe at a right angle on the specimen surface ( Page 42). The probe can be lifted off after the measurement acquisition, i.e., after the reading appears on the display. The instrument is ready to make measurements.

Observe the following during the measurement:

- Measurements should be made within the reference area.
- To avoid erroneous readings, do not allow the probe to hover above the specimen.
- To obtain a correct air value, the distance to the specimen should be at least 25 mm.
- To allow sufficient time for a measurement accept, the time between individual measurements must be greater than 0.5 seconds.

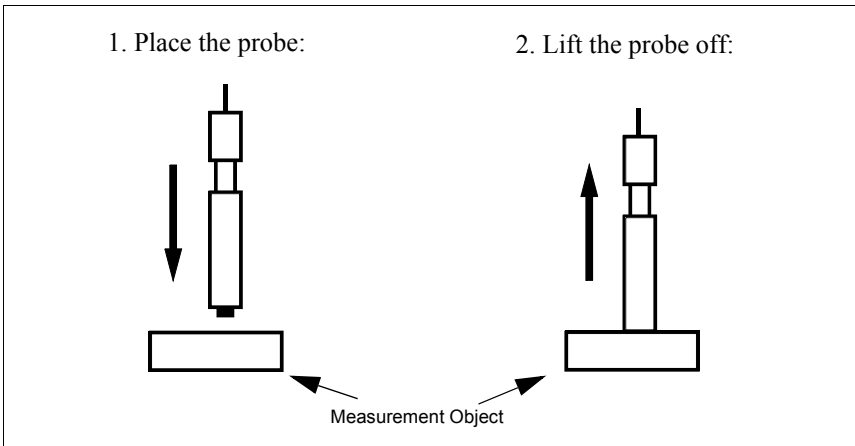

Fig. 7-1 Measurement using an axial probe

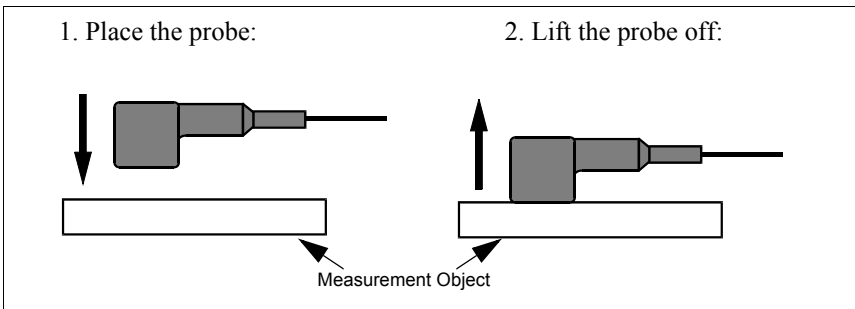

Fig. 7-2 Measurement using an angle probe

7.3.1 Measurement Acquisition

As long as automatic measurement acquisition is enabled, measurement acquisition occurs automatically immediately after the probe is placed on the specimen. An audible signal will sound after the measurement acquisition (unless it has been disabled) (☞ 7.3.4 ‘Audible Signals After the Measurement Acquisition’, beginning on Page 93).

With the “free-running display mode on, measurement acquisition can be triggered in the following manner (☞ 7.6 ‘Measurements in the Free-Running Display Mode’, beginning on Page 104):

- Pressing the **ENTER** key
 - Transmitting one of the ASCII characters “**G0**”, “**ES**”, “**EN**” or
 - Transmitting the control character “**ESC?**” via the USB port (ESC = ASCII27)
- (☞ 9.4.2 ‘Control Commands’, beginning on Page 142)

Regardless of how the measurement acquisition occurred, the reading will appear on the LCD display following the measurement acquisition.

7.3.2 Measurements With External Start Enabled

When an automatic measurement acquisition is not desired, e.g., when making measurements in pipes, boreholes or grooves, external start should be enabled and automatic measurement acquisition disabled (Enabling externally triggered measurement acquisition and disabling automatic measurement acquisition:

 Page 180).

Externally triggered measurement acquisition is recommended when the ferrite content is to be documented in a fixed, pre-specified lateral grid. In this manner, a measurement is registered even if the ferrite content is too low for an automatic measurement acquisition, i.e., when it is near or equal to zero.



With external start enabled, the measurement acquisition can be triggered manually in the following ways once the probe is positioned on the measurement location:

- Press the \wedge key
(not with a normalization or calibration)
- Press the **FINAL-RES** key
(only during a normalization or calibration)
- Transmitting the “**ES**” command via the USB port
( 9.4.2 ‘Control Commands’, beginning on Page 142)



With externally triggered measurement acquisition, the measurement acquisition can be delayed by up to 2.5 sec ( 10.7.3 ‘External Start’, beginning on Page 180)

7.3.3 Automatic Measurement Acquisition

A description of the two acquisition modes will follow under modes for automatic start of measurements after placing the probe). However, both methods will also work with externally triggered measurement acquisition ( Page 90), but not in the free-running-mode ( Page 104)!

Measurement Capture Through Area Measurements

With area measurements, the single readings are taken as fast as possible until the probe is lifted off. Only the determined mean value is stored.

This measuring mode is advantageous if a mean values of the ferrite content distribution is to be determined quickly within a reference area. This mean value is added to a measurement series as a single reading.

With online output of the single readings via the USB port enabled, only this mean value will be output as well.



The magnetic poles are subject to increased wear when moving the probe across a surface.

Key sequ. / Action	Detail of the LCD display	Explanation
--------------------	---------------------------	-------------

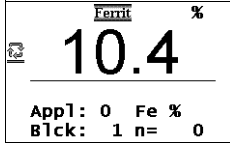
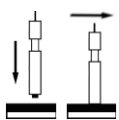

Switch area measurement on from the menu Service Functions/Measurement/Measuring Mode (10.7.4 'Measuring Mode - Standard/Area Measurement/Automatic Measurement', beginning on Page 182) and place the probe on the specimen.

The LCD displays the symbol  for as long as the probe is on the specimen. In addition, an audible signal sounds when the probe is placed on the specimen. Move the probe with a slight and uniform pressure across the specimen.

- [Appl:]**: Application number
- [Fe%]**: Displays ferrite contents in ferrite percent (measured variable of the open Application 10.7.6 'Measured Variable', beginning on Page 185)
- [Blck:]**: Number of the current block
- [n=]**: Number of the measurements / block size stored in the Application

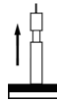



Lift the probe off the specimen.

An audible signal indicates the end of the measurement.

Measurement Capture Through Automatic Measurements

With automatic measurements, a specified number of readings is taken with a selectable time interval between 2 measurements. In contrast to the area measurement, all single readings will be stored ( Page 90).

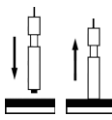
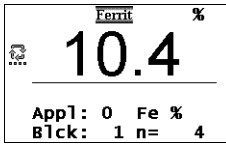
This measuring mode can be advantageous, for example, when the ferrite content distribution shall be determined along a line. If the probe is moved by hand or a suitable mechanical device at a consistent speed along a line, then the measurement points will be at equal distances.

Key sequ. / Action	Detail of the LCD display	Explanation
		<p>Switch “Autom. Measurement” on from the menu Service functions/Measurement/ Measuring Mode and select the desired number of measurements and the time interval of the measurements ( 10.7.4 ‘Measuring Mode - Standard/ Area Measurement/Automatic Measurement’, beginning on Page 182).</p>
		<p>Place the probe on the specimen. The LCD displays the  symbol for as long as the probe is on the specimen. An audible signal sounds for every measurement that occurred. All measurement data are evaluated statistically.</p>
		<p>Lift the probe off the specimen.</p> <p>[Appl:]: Application number [Fe%]: Displays ferrite contents in ferrite percent (measured variable of the open Application  10.7.6 ‘Measured Variable’, beginning on Page 185) [Blck:]: Number of the current block [n=]: Number of the measurements / block size stored in the Application</p>

7.3.4 Audible Signals After the Measurement Acquisition

An audible signal will sound after the measurement acquisition (unless it has been disabled). The measurement acquisition signal indicates that a signal arriving from the probe has been recognized and that the probe can be lifted off the specimen.

In addition to measurement acquisition signal, the audible signals listed in the following Table may sound. Where applicable, the signals may sound in succession.

For example, if at a measurement with a fixed block size the last reading of a block has exceeded the upper specification limit, the measurement acquisition signal will sound followed by two short signals for exceeding the upper specification limit and one finally a long signal indicating the end of the block.

As an option, the measurement acquisition signal can be disabled (☞ 10.7.1 'Audible Signal', beginning on Page 178).
The other audible signals cannot be disabled!

Signal	Meaning
1 x short	Measurement below lower specification limit. (☞ 7.3.5 'Measurements With Tolerance Limits Enabled', beginning on Page 94)
2 x short	Upper specification limit is exceeded. (☞ 7.3.5 'Measurements With Tolerance Limits Enabled', beginning on Page 94)
1 x long	The block was concluded automatically and the block result was generated (☞ 7.3.6 'Measurements With a Fixed Block Size', beginning on Page 94) or the block was changed (☞ 10.6.3 'Matrix Mode', beginning on Page 174")
2 x long	The measurement was recognized as an outlier (☞ 7.3.8 'Measurements With Outlier Rejection Enabled', beginning on Page 97).

7.3.5 Measurements With Tolerance Limits Enabled

Having the tolerance limits enabled allows for a simple and quick determination if the measured ferrite contents are within specified limits ( Page 54).



As long as the tolerance limits are enabled,  will appear on the LCD display.

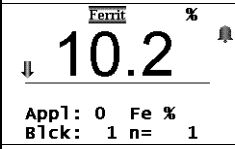
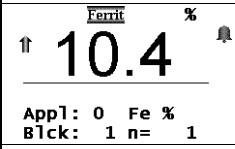

Detail of the LCD display	Explanation
	<p>After a measurement is taken that violates the lower specification limit, ↓ appears in front of the reading on the LCD display. In addition, a brief audible signal sounds after the measurement acquisition to indicate the violation of the tolerance limit.</p>
	<p>After a measurement is taken that violates the upper specification limit, ↑ appears in front of the reading on the LCD display. In addition, two brief audible signals sound after the measurement acquisition to indicate the violation of the tolerance limit.</p>

If the measurement acquisition signal has been disabled, only the signal, or the signals, for violating the tolerance limits will sound.

With outlier rejection enabled, the audible signals indicating an outlier measurement will sound when an outlier is recognized. In this case, the violation of the tolerance limit will not be indicated acoustically.

7.3.6 Measurements With a Fixed Block Size



When making measurements with a fixed block size,



- the block creation is carried out automatically after an adjustable number of measurements has been performed by the instrument (Setting the Block Size:  Page 57).
-  appears on the LCD display after the last measurement of the block has been taken, and

- the closure of the block is indicated by a long audible signal (if the measurement acquisition signal has been disabled, only the signal to indicated the block closure will sound).

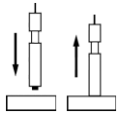
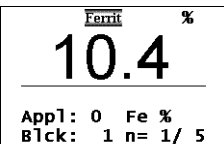

With a connected and powered up printer, it is now possible to print the block result automatically after the block closure or upon ( 10.5.4 'Block Result', beginning on Page 167).

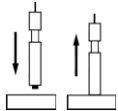
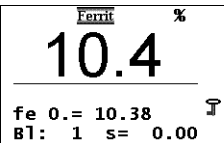
Key sequ. / Action	Detail of the LCD display	Explanation
--------------------	---------------------------	-------------

		<p>Make a measurement. The reading will appear on the LCD display.</p> <p>[Appl:]: Application number [Fe%]: Displays ferrite contents in ferrite percent (measured variable of the open Application  10.7.6 'Measured Variable', beginning on Page 185) [Blck:]: Number of the current block [n=]: Number of the measurements / block size stored in the Application</p>
---	---	---

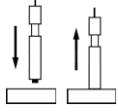
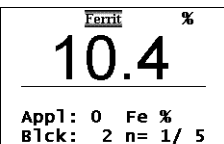
		<p>Perform the number of measurements required for an automatic block closure.</p> <p>:Block is closed; no more measurements can be taken in this particular block.</p>
---	---	--

		<p>A new blocks starts automatically when the next measurement is taken.</p>
--	--	--

 Individual readings / erroneous measurements can be overwritten in a closed block ( 7.5.4 'Overwriting Individual Erroneous Measurements at a Later Time', beginning on Page 102).

7.3.7 Measurements in Auto-Averaging Mode

With measurements made in auto-averaging mode, the mean value generated from a number of single readings is stored in place of the single readings. Thus, this mode is particularly well suited for rough surfaces.

(For setting the number of single readings from which the average of the readings to be stored is determined:  5.6.4 'Auto-Averaging Mode', beginning on Page 58)

In the auto-averaging mode and with outlier rejection enabled, the single readings that are recognized as outliers will **not** be integrated in the measurement calculation! For example, if an outlier is recognized at $i = 5$, only the 4 remaining readings will be used to generate the mean value.

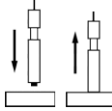
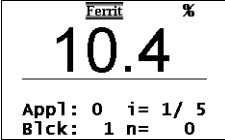
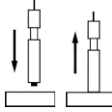
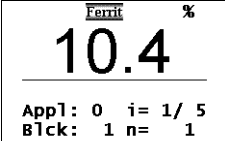
Key sequ. / Action	Detail of the LCD display	Explanation
		<p>Make a measurement. The reading will appear on the LCD display.</p> <p>[Appl:]: Application number [i=]: Number of single readings measured / set number of single readings to be combined [Blck:]: Number of the current block [n=]: Number of the measurements stored in the Application</p>
		<p>Perform the number of measurements required for the number of stored measurements to be increased by one ([i=0/n] will be displayed.) The mean value of the performed single readings will be displayed and stored.</p>

7.3.8 Measurements With Outlier Rejection Enabled

When making measurements with outlier rejection enabled:

- the outlier measurements recognized by the instrument will appear on the LCD display and will be indicated acoustically (see 5.6.5 ‘Outlier rejection’, beginning on Page 60),

Detail of the LCD display	Explanation
---------------------------	-------------

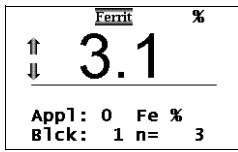

- ↓ and ↑ will appear in front of the reading on the LCD display after a measurement has been taken that has been recognized by the instrument as an outlier,

- two long audible signals will sound to indicated the outlier measurement in addition to the audible signal for the measurement acquisition,
- recognized outliers will not be integrated in the evaluation of the current block or the current Application.,
- only the signals for indicating the outlier measurements will sound if the measurement acquisition signal has been disabled,
- outlier measurements recognized in the auto-averaging mode will not be integrated in the measurement calculation, and
- only the audible signals indicating an outlier measurement will sound when an outlier is recognized (a violation f the tolerance limits will not be indicated).

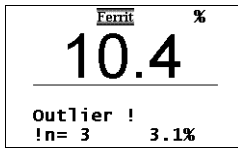

Detail of the LCD display	Explanation
---------------------------	-------------



Outlier! appears briefly in the information lines of the LCD display in addition to the audible signal if a past reading with the number n (in the example, n = 1) is recognized as an outlier measurement (thereafter, the measurement just taken will appear).

7.4 Documenting the Measurement with a Printer

With a connected and powered up printer, it is possible to print individual readings by pressing the **PRINT** key

( Fig. 7-3 and Fig. 7-4). [**Print single readings on**] must be set from the Service Functions/Print menu ( 10.5.3 'Print Individual Single Readings', beginning on Page 166).

Application No. 3		Block No.: 1	
n=	1	fe =	10.8%
n=	2	fe =	10.8%
n=	3	fe =	10.8%
n=	4	fe =	10.8%
n=	5	fe =	3.1%
n=	6	fe =	10.8%
n=	7	fe =	10.8%

Fig. 7-3 Printout of the readings (example)

If tolerance limits are enabled when making measurements, the readings will be entered between or next to the tolerance limits on the printout ( Fig. 7-4).

Application No. 3		Block No.: 1	
n	LSL	USL	
	10.8%	11.0%	
1	<<<		10.8
2	*		10.8
3	*		10.8
4	*		10.8
5	<<<		3.1
6	*		10.8
7	<<<		10.8

Measurement below lower 

Fig. 7-4 Printout of the reading with tolerance limits (example)

For measurements in auto-averaging mode, only the mean value computed from the single readings will be printed and stored. The individual readings are not stored.

If automatic block creation is enabled (5.6.3 ‘Automatic Block Size and Block Creation’, beginning on Page 57), the readings and the block results of all blocks of the open Application will be printed in succession:

```

Application No. 0 Block No.: 1
n  LSL      USL
  10.2%    10.8%
1| | *      | | 10.4
2| | *
3| | *      | | 10.3
4|<<|      | | 3.1
5| | *      | | 10.3
FISCHER FERITSCOPE FMP30    24.07.08
Appl.No. 0    -- Block result --
Block No.: 1    24.07.08 22:05
Mean value fe. = 8.89 +/- 4.04%
Std. dev. s = 3.25%    n = 5
C. O. V. = 36.58%
lowest meas.= 3.07%
highest meas. = 10.36%
  1 values < LSL( 10.20% )= 20.00%
  0 values > USL( 10.80% )= 0.00%
Application No. 0 Block No.: 2
n  LSL      USL
  10.2%    10.8%
1| | *      | | 10.3
2| | *      | | 10.4
3| | *      | | 10.4
4| | *      | | 10.2
5| | *      | | 10.2
FISCHER FERITSCOPE FMP30    24.07.08
Appl.No. 0    -- Block result --
Block No.: 2    24.07.08 22:05
Mean value fe. = 10.29 +/- 0.10%
Std. dev. s = 0.08%    n = 5
C. O. V. = 0.79%
lowest meas.= 10.21%
highest meas. = 10.38%
  0 values < LSL ( 10.20% )= 0.00%
  0 values > USL ( 10.80% )= 0.00%
Application No. 0 Block No.: 3
n  LSL      USL
  10.2%    10.8%
1| | *      | | 10.3
2|<<|      | | 10.2
  
```

Fig. 7-5 Printout of the block results (example)

The readings and the block results of a single block can be printed during the evaluation of this particular block by pressing the **PRINT** key.()  8.1.1 ‘Documenting the Block Result With a Printer’, beginning on Page 128

FISCHER FERITSCOPE FMP30	24.07.08
Appl.No. 0	-- Block result --
Block No.: 3	24.07.08 12:09
Mean value fe. =	10.15 +/- 0.13%
Std. dev. s =	0.11% n = 5
C. O. V. =	1.06%
lowest meas.=	10.07%
highest meas. =	10.33%
4 values < LSL (10.20%)=	80.00%
0 values > USL (10.80%)=	0.00%

Fig. 7-6 Printout of the block results of a single block (example)

Explanation to Fig. 7-3 up to Fig. 7-6:

FISCHER FERITSCOPE FMP30	Instrument type:
2008-07-24	Current date
Application No.	Number of the Application
Block No.	Number of the open measurement block
n	Consecutive number of the reading
fe	Measured value of the ferrite content
LSL/USL	Upper / lower specification limit
*	Reading is within the tolerance limits
<< / >>	Reading violates the tolerance limits
fe.	Mean value of all readings obtained for this step of the calibration.
s	Standard deviation of the readings obtained for this step of the calibration.
C. O. V.	Coefficient of variation

7.5 Erroneous Readings

7.5.1 Deleting Erroneous Readings

If an erroneous reading is recognized directly after measurement acquisition, the reading can be deleted by pressing **DEL**.

The deleted reading will then not be included in the generation of the block and final results.

Repeated pressing of **DEL** will delete all readings of the open block in succession.

7.5.2 Deleting All Readings of a Block That Has Not Been Closed

Pressing **DEL** during an evaluation of an open block will delete all readings that are stored in the open block that has not been closed ( 8.1 ‘Evaluation of the Current Block “Block Result”’, beginning on Page 125).

7.5.3 Deleting All Readings of an Application



All readings stored in the open application can be deleted completely during the evaluation of the open Application. This is accomplished by pressing **FINAL-RES** and then twice the **DEL** ( 8.2 ‘Evaluation of the Open Application “Final Result”’, beginning on Page 131).

7.5.4 Overwriting Individual Erroneous Measurements at a Later Time

During the evaluation of the current block, individual erroneous measurements of the current block or of earlier blocks can be overwritten with new readings.



The instrument does not carry out outlier rejection when overwriting stored measurement data (even if outlier rejection is enabled).

Key sequ. / Action	Detail of the LCD display	Explanation
BLOCK-RES	<pre> Block: 3 n = 2 30.07.08 04:07 fe. = 10.28 % s = 0.04 % cov = 0.36 % </pre>	<p>Use BLOCK-RES to start the evaluation of the open block ( 8.1 'Evaluation of the Current Block "Block Result"', beginning on Page 125).</p> <p>[Block:]: Number of the current block [n=]: Number of readings stored in the current block. DATE and TIME display [fe.]: Displays the mean value of the current block. [s]: Standard deviation of the measurements made [COV]: Coefficient of variation</p>
^ or v	<pre> Block: 2 n = 5 30.07.08 04:07 fe. = 10.28 % s = 0.04 % cov = 0.38 % </pre>	<p>Use the arrow key ^ or v to select the block reading that is to be overwritten is located.</p> <p> identifies the closed block.</p>

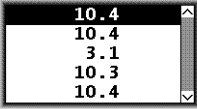
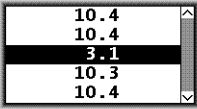
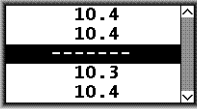
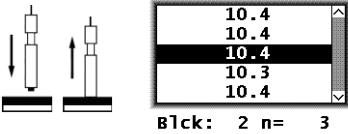
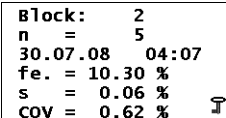
Key sequ. / Action	Detail of the LCD display	Explanation
MENU	 <p>Block: 2 n= 1</p>	Use MENU to retrieve the display of the single readings.
	 <p>Block: 2 n= 3</p>	<p>[Block:]: Number of the selected block [n=]: Consecutive number of the displayed single reading</p> <p>Use the arrow key \wedge or \vee to select the single reading that is to be overwritten.</p> <p>[Remeas.: DEL]: Use DEL to delete the displayed single reading [Back: MENU]: Use MENU to exit the display of the single readings.</p>
DEL	 <p>Block: 2 n= 3</p>	Use DEL to delete the reading.
	 <p>Block: 2 n= 3</p>	<p>Use remeasure: Prompt to make a new measurement [Cancel: DEL]: Use DEL to cancel the procedure (the reading stored previously will be retained)</p> <p>Make a measurement. The measured value will be displayed.</p> <p>[Block:]: Number of the selected block [n=]: Consecutive number of the newly measured single reading</p>
		<p>Select and overwrite additional readings or:</p> <p>[Back: MENU]: Press MENU to return to the display of the evaluation of the current block.</p>
MENU		Pressing MENU stores the newly measured reading and returns you to the evaluation display of the current block.

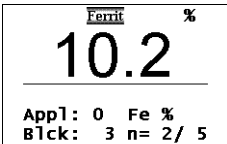
Key sequ. / Action	Detail of the LCD display	Explanation
ENTER		<p>Use ENTER to end the block result display. The last block will be closed automatically and a new block will open. If additional measurements are to be made in the last not yet closed block, do not press ENTER; instead, select the still open block and press the arrow \wedge.</p> <p>The instrument is again ready to make measurements.</p>

7.6 Measurements in the Free-Running Display Mode

When making measurements in the “free-running” display mode, the ferrite content distribution across the surface can be determined simply by moving the probe along the surface. With the “free-running” display mode,

- the readings are displayed continuously, and
- the readings are not accepted and stored automatically,
- the data are output continuously via the USB port only if [Free-running transmit on] has been selected from the Service functions.



Measurements that are outside the measurement range, e.g., when the probe is lifted off the surface, are also output to the USB port.

- As long as the “free-running” mode is on, measurement acquisition can be triggered using **ENTER**.



7.6.1 Turning the Free-Running Display Mode On/Off

To enable the free-running display mode: Press the ∨ arrow key.

- The “free-running” display mode remains enabled until it is disabled; i.e., it does not need to be enabled every time the instrument is powered up.

To disable the free-running display mode: Press the arrow key ∨ again.

As long as the “free-running” display mode is enabled,

-  will appear on the LCD display,
- the acquisition of a reading can be triggered using **ENTER** or by transmitting one of the ASCII characters “**GO**”, “**ES**”, “**EN**” or the control character “**ESC?**” (ESC = ASCII27) via the USB port ( 9.4.2 ‘Control Commands’, beginning on Page 142),
- the acquisition of reading can be triggered using \wedge if externally triggered measurement acquisition is enabled,
- it is not possible to retrieve the service functions!

7.6.2 Procedure For Making Measurements With the Free-Running Display Mode



The magnetic poles are subject to increased wear when moving the probe across a surface.

Key sequ. / Action	Detail of the LCD display	Explanation
<p>∨</p>		<p>Press the arrow key ∨ to enable the free-running display mode.</p> <p> will appear on the LCD display.</p> <p>[Appl.]: Number of the open Application [Fe%]: Displays ferrite contents in ferrite percent (measured variable of the open Application 10.7.6 'Measured Variable', beginning on Page 185) [Blck]: Number of the block [n=]: Number of readings in the block</p>
		<p>Place the probe on the specimen and move it across the surface of the specimen to determine the ferrite content distribution.</p>
		<p>Lift the probe off the specimen.</p>
<p>∨</p>		<p>Use ∨ to disable the free-running display mode.</p>



The audible signals for indicating tolerance limit violations are disabled automatically when making measurements in the free-running display mode.

A violation of a tolerance limit will be indicated only through ↓ and ↑ or displayed on the CD display.



7.6.3 Analog Display

When making measurements in the “free-running” display mode, the analog display facilitates a quick recognition of tendencies in ferrite content changes. If analog display is enabled and measurements are made in the “free-running” display mode, the analog display with the set limits will appear in place of the information lines. The reading will appear between the limits as an analog bar. (Enabling the analog display:  Page 173).





As long as the tolerance limits have not been enabled, the measurement range limits of the connected probe will be displayed as the limits for the analog display. Once the tolerance limits have been enabled, the set tolerance limits will be displayed as the limits for the analog display.  5.6.1 ‘Tolerance Limits’, beginning on Page 54

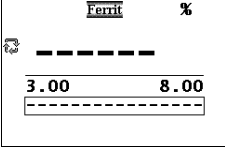

With the free-running mode enabled, the tolerance limits cannot be set through a measurement but only via the arrow keys.

If a reading violates the upper or lower specification limit when making measurements in the “free-running” display mode and the measurement acquisition signal is enabled, the respective signal for indicating the violation of the tolerance limit will sound ( 7.3.4 ‘Audible Signals After the Measurement Acquisition’, beginning on Page 93 or  7.3.5 ‘Measurements With Tolerance Limits Enabled’, beginning on Page 94).

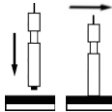
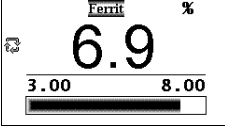
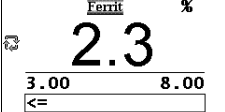
If the measurement acquisition signal is disabled during measurements in the “free-running” display mode, the audible signal for indicating a violation of the tolerance limits is automatically disabled as well ( 10.7.1 ‘Audible Signal’, beginning on Page 178).

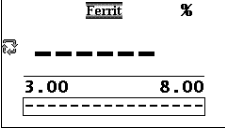
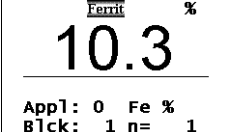
Key sequ. / Action	Detail of the LCD display	Explanation
<p>∨</p>		<p>Press the arrow key ∨ to enable the free-running display mode.</p> <p> will appear on the LCD display.</p> <p>[3.00 8.00]: Limits for the analog display (example).</p>
	 	<p>Place the probe on the specimen and move it across the surface of the specimen to determine the lateral ferrite content distribution.</p> <p>[3.00 8.00]: Limits for the analog display (example).</p> <p>[<= =>]: The lower or upper limit of the analog display is violated</p>
		<p>Lift the probe off the specimen.</p>
<p>∨</p>		<p>Use ∨ to disable the free-running display mode.</p> <p>The last reading taken before the free-running display mode will be displayed.</p>

7.7 Measurements in Standard and Matrix Measuring Mode

The preparations required for making the actual measurement are independent of the selected measuring mode and are described in the Chapters

“ 7.1 ‘Preparing for a Measurement’, beginning on Page 86 and

 7.3 ‘Making a Measurement’, beginning on Page 87.

Measuring modes can be changed from the service functions only

( 10.6.3 ‘Matrix Mode’, beginning on Page 174).





The instrument is re-initialized automatically when changing from the standard to the matrix measuring mode. During a re-initialization, all Applications and all measurement data stored in them are deleted and all settings of the service functions are reset to their default settings. After the re-initialization, i.e., also after changing the measuring mode, the required Applications will need to be set up anew and the desired settings need to be established again in the service functions!

7.7.1 The Standard Measuring Mode

In the Standard measuring mode, measurements are made on the same specimen (e.g., on a bolt) in succession and are combined to a block and evaluated using **BLOCK-RES**. The resulting block mean value represents the local ferrite content of the reference area.

In the standard measuring mode, readings can be stored only in the respective latest not yet closed block of an Application.

The individual applications may contain different numbers of blocks and different numbers of readings may be stored in a block. However, if automatic block creation is enabled in an Application, only blocks of the set block size can be created ( 5.6.3 ‘Automatic Block Size and Block Creation’, beginning on Page 57 and  7.3.6 ‘Measurements With a Fixed Block Size’, beginning on Page 94).

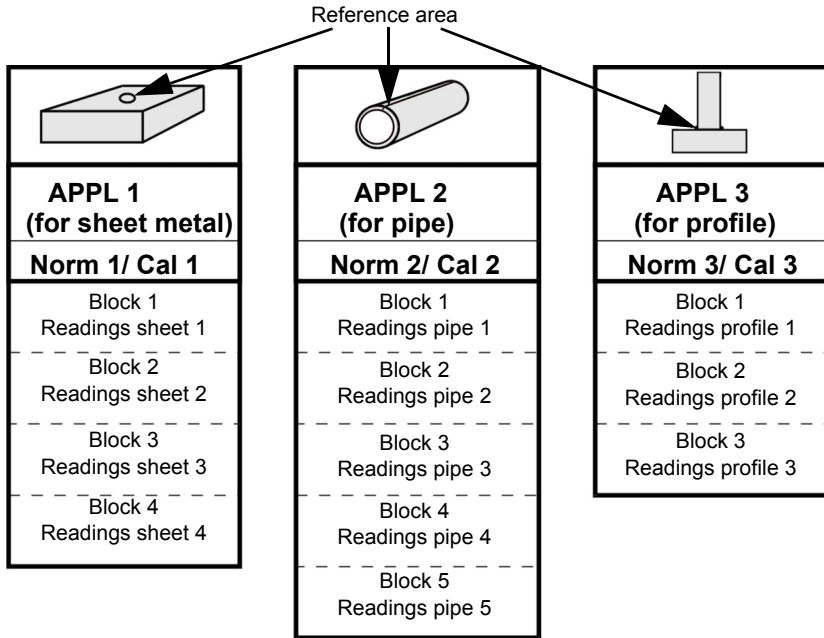

Fig. 7-7 Example for the configuration of the Application in the Standard measuring mode

7.7.2 Making Measurements in the Standard Measuring Mode

When making measurements in the Standard measuring mode, the readings can be stored only in the respective latest not closed block.



It is not possible to select freely the block where the next reading is to be stored.

7.7.3 The Matrix Measuring Mode

When changing to the matrix measuring mode, the number of Applications and the number of blocks must be entered. The same number of blocks is set up for each Application. Each block can receive the same maximum number of readings.

After entering the number of Applications and blocks, the instrument will automatically compute and display the maximum number of readings. For example, if **[Matrix mode on (3/20/318)]** appears when the instrument configuration is displayed, a maximum of 3 Applications each with 20 blocks each with a maximum number 318 readings can be set up.



Production Line 1	Production Line 2	Production Line 3
		
APPL 1 (for Tank Model A)	APPL 2 (for Tank Model B)	APPL 3 (for Tank Model C)
Norm 1 / Cal 1	Norm 2 / Cal 2	Norm 3 / Cal 3
Block 1 (all measurements of the upper welded joints) $Fe_1 = 71 \text{ FN (Tank A1)}$ $Fe_2 = 71 \text{ FN (Tank A2)}$... $Fe_N = 69 \text{ FN (Tank AN)}$	Block 1 (all measurements of the right welded joints) $Fe_1 = 55 \text{ FN (Tank B1)}$ $Fe_2 = 57 \text{ FN (Tank B2)}$... $Fe_N = 58 \text{ FN (Tank BN)}$	Block 1 (all measurements of the upper welded joints) $Fe_1 = 50 \text{ FN (Tank C1)}$ $Fe_2 = 51 \text{ FN (Tank C2)}$... $Fe_N = 53 \text{ FN (Tank CN)}$
Block 2 (all measurements of the lower welded joints) $Fe_1 = 73 \text{ FN (Tank A1)}$ $Fe_2 = 72 \text{ FN (Tank A2)}$... $Fe_N = 68 \text{ FN (Tank AN)}$	Block 2 (all measurements of the left welded joints) $Fe_1 = 66 \text{ FN (Tank B 1)}$ $Fe_2 = 67 \text{ FN (Tank B 2)}$... $Fe_N = 68 \text{ FN (Tank B N)}$	Block 2 (all measurements of the lower welded joints) $Fe_1 = 51 \text{ FN (Tank C1)}$ $Fe_2 = 52 \text{ FN (Tank C2)}$... $Fe_N = 66 \text{ FN (Tank CN)}$
⋮	⋮	⋮
Block 20 (all measurements of the walls) $Fe_1 = 76 \text{ FN (Tank A1)}$ $Fe_2 = 74 \text{ FN (Tank A2)}$... $Fe_N = 78 \text{ FN (Tank AN)}$	Block 20 (all measurements of the walls) $Fe_1 = 69 \text{ FN (Tank B1)}$ $Fe_2 = 73 \text{ FN (Tank B2)}$... $Fe_N = 75 \text{ FN (Tank BN)}$	Block 20 (all measurements of the walls) $Fe_1 = 62 \text{ FN (Tank C1)}$ $Fe_2 = 68 \text{ FN (Tank C2)}$... $Fe_N = 70 \text{ FN (Tank CN)}$

Fig. 7-8 Example for the configuration of the Application in the Matrix measuring mode

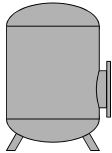
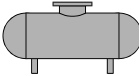

All three Applications contain 20 blocks each. With 3 Applications each with 20 blocks, a maximum of $n=318$ readings can be stored per block.

The matrix measuring mode is suited for ferrite content measurements when the measurements are to be made on different specimens of the same type in succession, always at certain reference areas, and the measurements of corresponding areas are to be combined into blocks. The matrix measuring mode is used, for example, in the chemical industry or in the boiler and steel construction industries.



When selecting a reference area where measurements in an Application are to be made, it should be observed that the same normalization and corrective calibration is underlying the determination of the ferrite content. Thus, only such reference areas should be selected for which no other normalization or corrective calibration is required.



The number of applications and blocks cannot be changed later on without a re-initialization.



On the LCD display, the Matrix measuring mode is indicated by

Automatic block creation is not available in the matrix measuring mode. Correspondingly, it is not possible to set a block size for automatic block creation during the application-specific settings using **MENU** (5.6 'Application Specific Settings', beginning on Page 52).

7.7.4 Making Measurements in the Matrix Measuring Mode



appears on the LCD display when the Matrix measuring mode is enabled.

In the matrix measuring mode, it is possible to change the blocks, i.e., to select the block where the next reading is to be stored manually or automatically (10.6.3 'Matrix Mode', beginning on Page 174).

Automatic Block changing

Automatic Block changing must be selected for the next reading to be stored in the next block automatically. Free block selection is not available with automatic block changing!

After the audible signal for the measurement acquisition, a long audible signal will sound to indicate block changing ( 7.3.4 ‘Audible Signals After the Measurement Acquisition’, beginning on Page 93).

Manual Block changing

Block changing must be done **manually** in order to allow for a free selection of the block where the next reading is to be stored. The desired block must be selected before making the measurement.

If manual block changing is selected, it is possible to store one reading in block 7 and the next in block 3, for example.

Key sequ. / Action	Detail of the LCD display	Explanation
BLOCK-RES	<div style="border: 1px solid black; padding: 5px; width: fit-content;"> <pre> Block: 7 n = 3 30.07.08 07:05 fe. = 10.32 % s = 0.07 % COV = 0.66 % </pre> </div>	<p>Use BLOCK-RES to start the block selection.</p> <p> will appear on the LCD display.</p> <p>[Block:]: Number or name of the current block [n=]: Number of readings stored in the current block. DATE and TIME display [fe.]: Displays the mean value of the current block. [s]: Standard deviation of the measurements made [COV]: Coefficient of variation</p>

Key sequ. / Action	Detail of the LCD display	Explanation
--------------------	---------------------------	-------------

^ or v

B	l	o	c	k	:	3
n	=					4
3	0	.	0	7	.	0
f	e	.	=	1	0	.
s	=					0
c	o	v	=			0
						7
						2
						%

Use the arrow keys to select the desired block and **ENTER** to confirm the block selection.

B	l	o	c	k	:	4
n	=					0
-	-	-	-	-	-	-
f	e	.	=	-	-	-
s	=					-
c	o	v	=			-
						%

The display shown to the left appears if a new block (without readings) is selected.

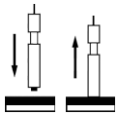

						Ferrit	%
0	.	0	0				
A	p	p	:	0	F	e	%
B	l	c	:	4	n	=	0

Make the measurement in the selected block on the next specimen.

A block will be closed automatically when during the measurement in the matrix measuring mode the maximum number of readings that can be stored in a block is reached. appears on the LCD display.

In addition, a long acoustical signal indicating the block closures sounds after the audible signal for the measurement acquisition.

If the measurement acquisition signal has been disabled, only the signal indicating the block closure will sound.

Details about the audible signals: Page 93.



If additional measurements are made in the matrix measuring mode while appears on the LCD display, these measurements will not be stored, printed or taken into account during the evaluation. After the measurement, the LCD display will briefly show the error message: "E024 - Block is full".

To store additional readings, select the block where the readings are to be stored (i.e., change the blocks manually) or delete the readings.

7.7.5 Assigning Block Designations

When making measurements in the Matrix mode, a customer-specific designation that can be comprised of a max. of 16 ASCII characters can be assigned to every Application and every block ( 5.5 ‘Assigning Application Designations’, beginning on Page 52).

Assigning the block designation can be carried out in the following manner:

- Use of the optional software MPNAME (the software is available from your authorized supplier or directly from the Helmut Fischer GmbH Institute for Electronics and Metrology.)
- Transmitting the command “SBN” via the USB port ( 9.4.2 ‘Control Commands’, beginning on Page 142)

Once Application or block designations have been assigned, the designations appear in the information lines of the LCD display, where applicable, alternating with the respective numbers. On printouts, the Application or block designation will appear **in place** of the Application or block number.

7.8 Correction Factors

The following factors influence the readings of a ferrite content measurement:

- Specimen curvature
- Specimen thickness
- Cladding thickness
- Edge distance to the measurement location
- Surface roughness

However, the surface roughness is strongly dependent on the ferrite content and the influence cannot be stated quantitatively. The influence is relatively small for ferrite contents of $< 10\%Fe$. It rises with an increasing ferrite content and can be reduced best by combining a sufficient number of single readings to one meaningful mean value.

These influences can be corrected by multiplication with the respective correction factors that can be obtained from the following information.

7.8.1 Influence of the Specimen Curvature

With curved specimens, the measured ferrite content deviates increasingly from the actual (true) ferrite content as the curvature increases.



The actual ferrite content can be computed in the following manner:

$$Fe_w = Fe_m \cdot \text{correction factor}$$

where:

Fe_w : actual (true) ferrite content

Fe_m : measured ferrite content

The correction factor, which is dependent on the curvature diameter \varnothing_c of the specimen can be obtained for convex and concave curvatures  Fig. 7-9 and  Fig. 7-10.

 Fig. 7-9 shows that the influence of the convex curvature is negligibly small for curvature diameters greater than 50 mm.

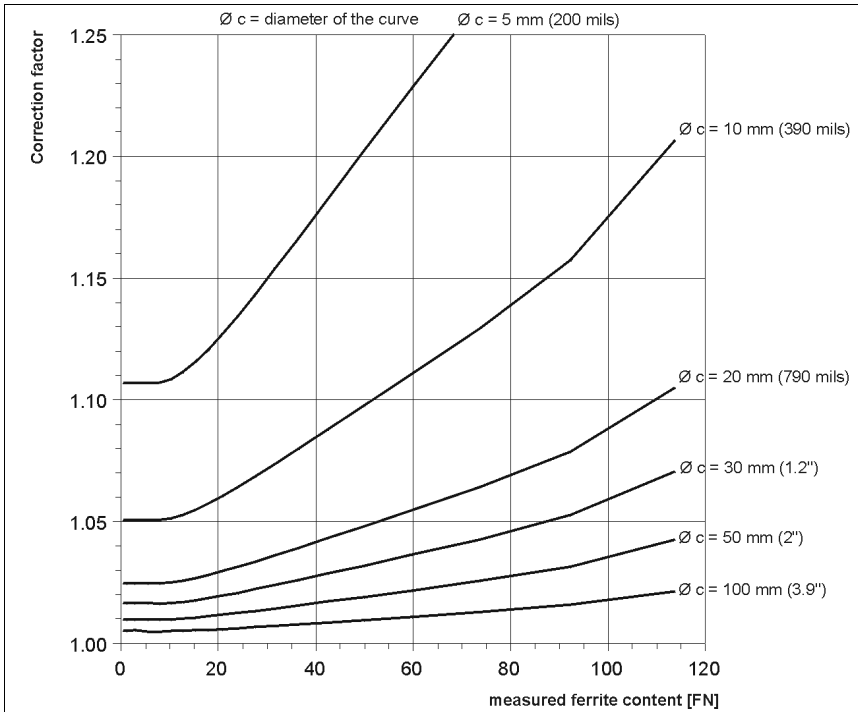



Fig. 7-9 Correction factors (convex curvature of the specimen)

Example:

A ferrite content of 50 FN is measured at the longitudinal line on the circumference of a cylinder with a diameter of 20 mm.

A corrective factor of 1.05 can be obtained from  Fig. 7-9.

The actual ferrite content is computed in the following manner:

$$\mathbf{Fe_w = Fe_m \cdot \text{correction factor}}$$

$$\mathbf{Fe_w = 50 \text{ FN} \cdot 1.05 = 52.5 \text{ FN}}$$

Fig. 7-10 shows that the influence of the concave curvature is negligible for curvature diameters greater than 80 mm.

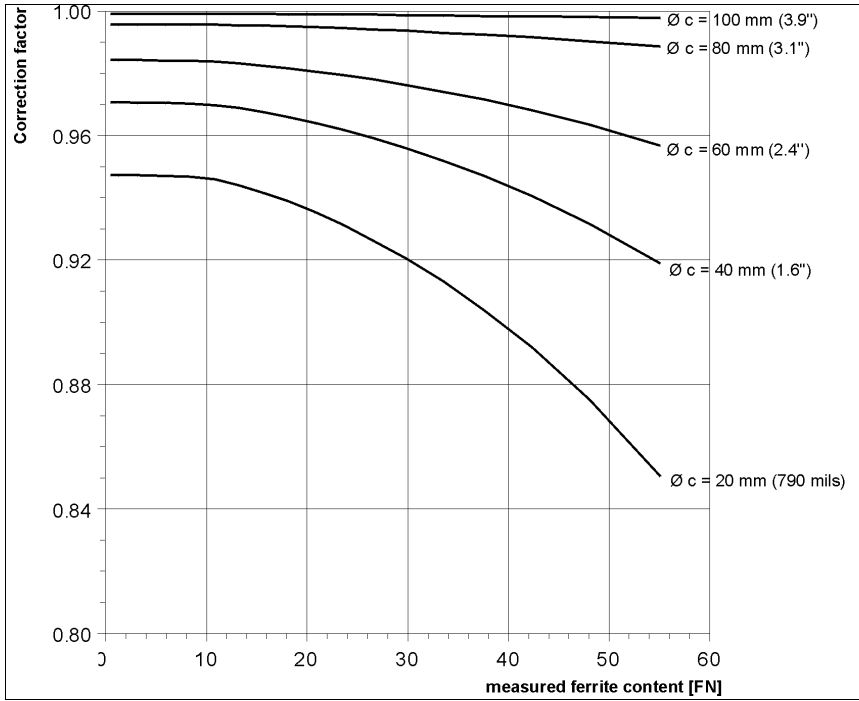

Fig. 7-10 Correction factors (concave curvature of the specimen)

7.8.2 Influence of the Specimen Thickness

With ferrite content measurements on thin specimens (e.g., sheet metal), the measured ferrite content deviates increasingly from the actual (true) ferrite content as the thickness of the specimen decreases.

The actual (true) ferrite content can be computed in the following manner:

$$Fe_w = Fe_m \cdot \text{correction factor}$$

where:

Fe_w : actual (true) ferrite content

Fe_m : measured ferrite content

The correction factor, which is dependent on the thickness of the specimen can be obtained from Fig. 7-11. Fig. 7-11 shows that the influence of the specimen thickness is negligibly small for specimens with a thickness greater than 2 mm.

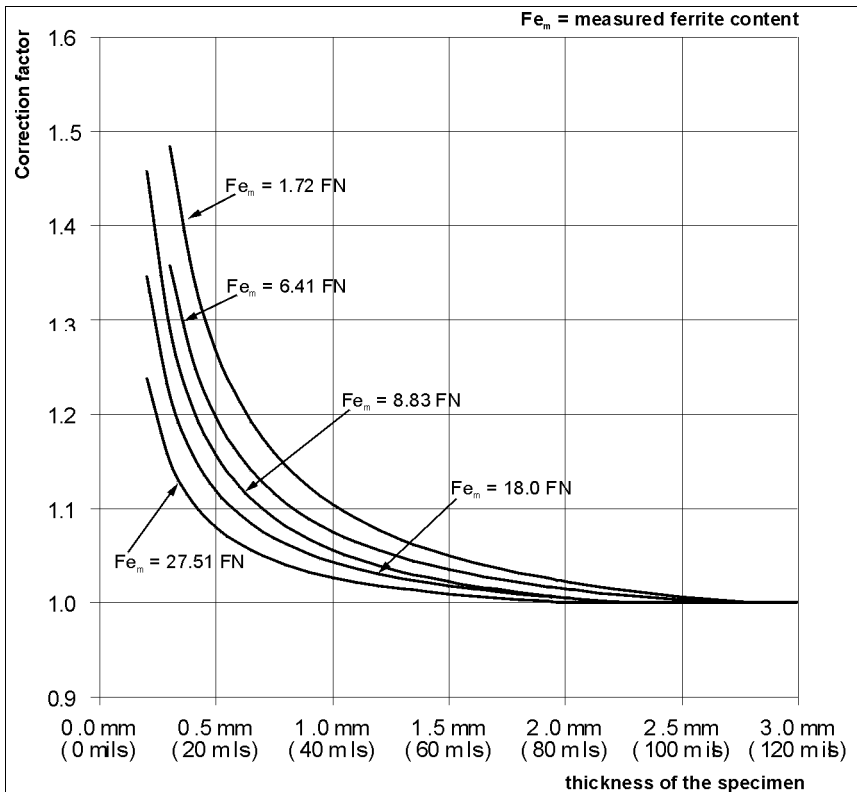



Fig. 7-11 Correction factors (thickness of the specimen)

Example:

A ferrite content of 1.72 FN is measured on a metal sheet with a thickness of 1 mm. A correction factor of 1.1 can be obtained from  Fig. 7-11. The actual ferrite content is computed in the following manner:

$$\begin{aligned} \mathbf{Fe_w} &= \mathbf{Fe_m} \cdot \mathbf{correction\ factor} \\ \mathbf{Fe_w} &= \mathbf{1.72\ FN} \cdot \mathbf{1.1} = \mathbf{1.89\ FN} \end{aligned}$$

7.8.3 Influence of the Cladding Thickness

When making ferrite content measurements in the weld seams of austenitic claddings on a ferromagnetic base material, the reading deviates increasingly from the actual (true) ferrite content as the cladding thickness decreases.



The actual ferrite content can be computed in the following manner:

$$\mathbf{Fe_w} = \mathbf{Fe_m} \cdot \mathbf{correction\ factor}$$

where:

Fe_w : actual (true) ferrite content

Fe_m : measured ferrite content

The correction factor, which is dependent on the cladding thickness can be obtained from  Fig. 7-12.  Fig. 7-12 shows that the influence of the cladding thickness is negligibly small for specimens with a cladding thickness greater than 2 mm.

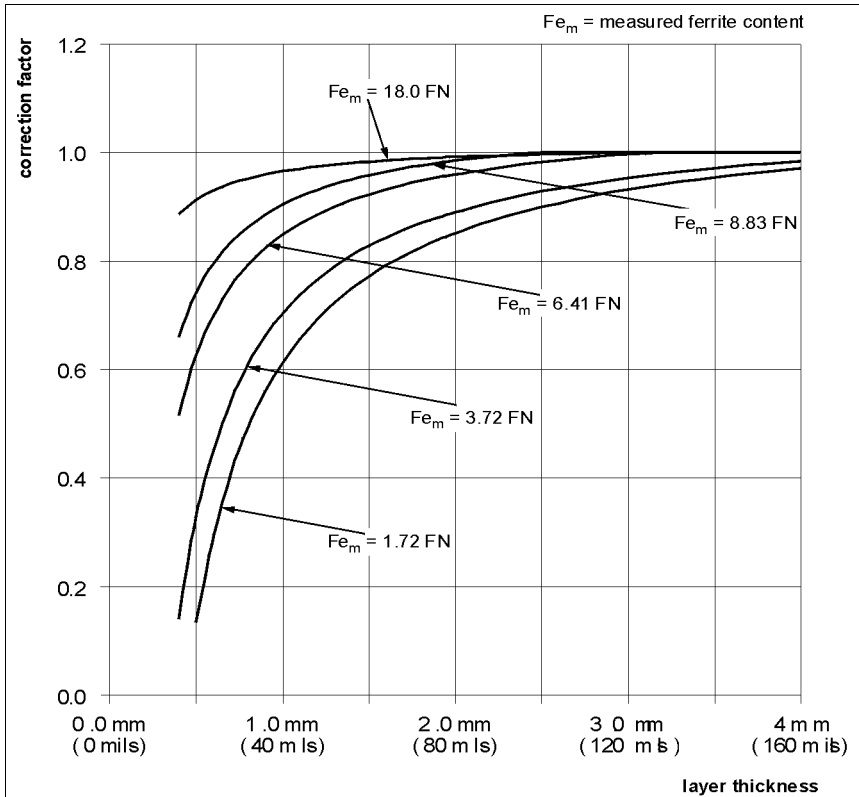

Fig. 7-12 Correction Factors (cladding thickness)

Example:

A ferrite content of 1.72 FN is measured on a 1 mm cladding. A corrective factor of 0.6 can be obtained from Fig. 7-12. The actual ferrite content is computed in the following manner:

$$\mathbf{Fe_w = Fe_m \cdot \text{correction factor}}$$

$$\mathbf{Fe_w = 1.72 \cdot 0.6 = 1.03 \text{ FN}}$$

7.8.4 Influence of the Edge Distance on the Measurement Location

The reading deviates with a decreasing distance of the measurement location from the edge increasingly from the actual (true) ferrite content.

The actual ferrite content can be computed in the following manner:

$$Fe_w = Fe_m \cdot \text{correction factor}$$

where:

Fe_w : actual (true) ferrite content

Fe_m : measured ferrite content

The correction factor, which is dependent on the edge distance can be obtained from Fig. 7-13. Fig. 7-13 shows that the influence of the edge distance is negligibly small for edge distances greater than 2 mm.

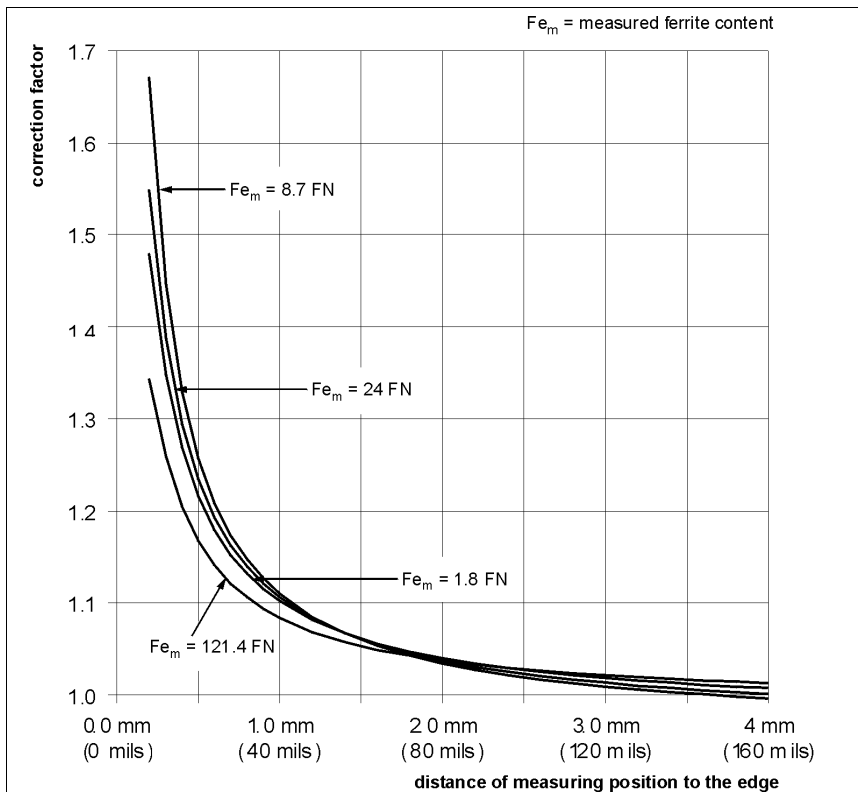

Fig. 7-13 Correction factors (edge distance of the measurement location)

Example:

A ferrite content of 24 FN is measured at a distance of the probe tip of 1 mm to the edge of the specimen. A correction factor of 1.1 can be obtained from Fig. 7-13. The actual ferrite content is computed in the following manner:

$$\mathbf{Fe_w = Fe_m \cdot \text{correction factor}}$$

$$\mathbf{Fe_w = 24 \text{ FN} \cdot 1.1 = 26.4 \text{ FN}}$$

8 Evaluation

The following options are available for evaluating the measured ferrite contents:

- Evaluation of the current block (**Block result**)
- Evaluation of the open Application (**Final result**)

An evaluation cannot be carried out in an Application, where no measurements have not yet been stored or where the measurements have been deleted! In this case, the display will not change after pressing **BLOCK-RES** or **FINAL-RES**.

The following parameters will be determined during the evaluation from the readings of the current block, or the open Application, respectively, and can be displayed in succession:

- Block or Application number
- Number of evaluated readings
- Date and time of the block closure of the evaluated block or the current date (if the evaluated block is not yet closed).
- Mean value
- Standard deviation or estimated standard deviation (the estimated standard deviation is shown in the final evaluation only when measurements are made with a fixed block size)
- Standard deviation s_a (is shown in the final evaluation only if the spread of the mean values cannot be explained from the spread within the blocks according to a variance analysis).
- Coefficient of variation V
- Lowest and highest reading or lowest and highest block mean value (if automatic block creation is enabled)
- Range R
- Number of measurements that are violating the lower or upper specification limits (only if tolerance limits are enabled).

In addition, the following will be printed when outputting the block or final results to a printer:

- Current date
- 95% confidence interval for the mean value

- Coefficient of variation V
- Standard deviation s_a (only for the final result if automatic block creation is enabled)
- Specification limit values LSL and USL
- Process capability indices C_p and C_{pk} as well as the estimated value s^{\wedge} for the standard deviation (only if tolerance limits and automatic block creation are enabled)
- Histogram with information whether a normal distribution is present, skewness and kurtosis as well as sum frequencies of the histogram classes (only for the final result if the corresponding histogram mode is set from the service functions).



If outlier rejection is enabled, recognized outlier measurements are not included in the evaluation.



More detailed information about the individual computed parameters.  Glossary.

8.1 Evaluation of the Current Block “Block Result”

After pressing **BLOCK-RES**, the most important characteristic statistical values are computed from the individual values taken until then in the current block and then displayed.

However, the block will not be closed until the evaluation ends through taking a new measurement or through pressing **ENTER**, or the instrument is switched off while the block result is displayed.

If there are no readings in the current block, pressing **BLOCK-RES** will display the block result of the last closed block.



If  appears on the LCD display during the evaluation, the evaluated block has already been closed.

When making measurements with a fixed block size and the last block has not been concluded, the next reading will be added to this block (even if **ENTER** is used to end the evaluation). In this case, the block will be concluded only after

the number of readings in this block corresponds to the set block size (7.3.6 ‘Measurements With a Fixed Block Size’, beginning on Page 94).

Evaluation of the current block (display “Block result”):

Key sequ. / Action	Detail of the LCD display	Explanation
BLOCK-RES	<pre> Block: 7 n = 2 30.07.08 07:24 fe. = 10.37 % s = 0.07 % COV = 0.70 % </pre>	Use BLOCK-RES to start the evaluation of the open block.
	<pre> min = 10.32 % max = 10.42 % R = 0.10 % <LSL= 0 >USL= 0 </pre>	[Page: BLOCK-RES]: Pressing BLOCK-RES again: Displays additional computed quantities.
	<pre> Block: 7 No. of Readings Date/Time Mean value Std. dev. s C.O.V. </pre>	[Info: CAL]: Press CAL to display an explanation of the computed parameter:
	<pre> Towest meas. highest meas. Range n < 10.0 % n > 10.5 % </pre>	 appears on the display when the tolerance limits are enabled.

Key sequ. / Action	Detail of the LCD display	Explanation
--------------------	---------------------------	-------------

Notes:

[Change block: ∇] or [Change block: ∆]: Use ∆ or ∇ to display the block result of the next or previous block.

[Single meas: MENU]: Use **MENU** to display the single readings of the evaluated block (then use ∆ or ∇ to display the readings in succession, use **MENU** to return to the block result).

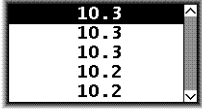

Blck: 4 n= 1

[Delete block: DEL]: Use **DEL** to delete the readings of the last not yet closed block (appears only during the evaluation of not closed blocks).

[Exit: ENTER]: Ends the block result display. The current block will be closed.

⏏ appears on the display once the block is closed.

ENTER

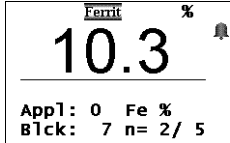

Use **ENTER** to end the block result display. The instrument is again ready to make measurements.

8.1.1 Documenting the Block Result With a Printer





If outlier rejection is enabled, recognized outlier measurements are not included in the evaluation.

Corresponding to the settings in Service menu/Print/Block result ( 10.5.4 'Block Result', beginning on Page 167), pressing **BLOCK-RES** allows for the block result of the current block to be printed with date and time stamp "automatically" or "on request" if a printer is connected and powered up.

If there are no readings in the current block, pressing **BLOCK-RES** will not result in a printout of the block result, instead the block result of the last closed block will be displayed.

When making measurements with a fixed block size, a printout of the respective block result occurs automatically upon the closing of a block if a printer is connected and powered up.

Corresponding to the settings of the block result mode made in Service functions/Evaluation ( 10.8 'Storage Mode', beginning on Page 187), either the "short" ( Fig. 8-1) or the "long" ( Fig. 8-2) version will be printed.

```

Application No. 0 Block No.: 3
n= 1 fe = 10.4%
n= 2 fe = 10.4%
n= 3 fe = 10.4%
n= 4 fe = 10.3%
n= 5 fe = 10.2%
FISCHER FERITSCOPE FMP30      25.07.08
Appl.No. 0      -- Block result --
Block No.: 3      24.07.08 23:10
Mean value fe. = 10.33 +/- 0.13%
Std. dev. s = 0.10%      n = 5
  
```

Fig. 8-1 Printout of a short block result (example)

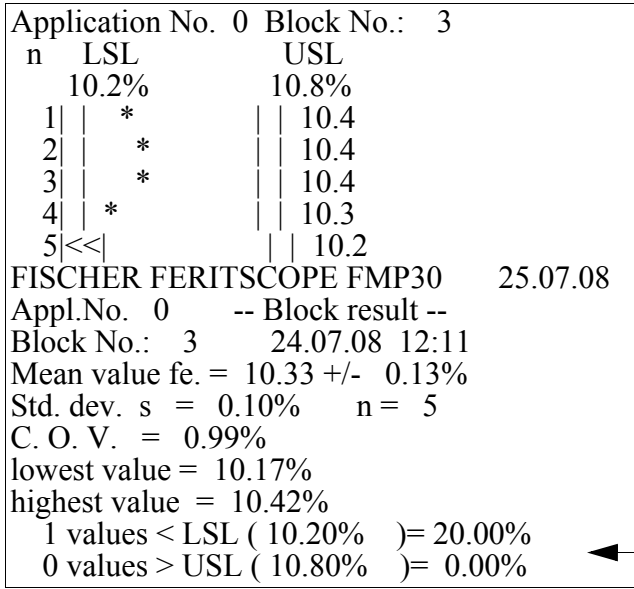

Displayed only when tolerance limits are enabled

Fig. 8-2 Printout of a long block result with tolerance limits enabled (example)

8.1.2 Printout of the List of Single Readings

Pressing the **PRINT** key during the block result display will also print a list of the single readings in addition to the long or short block result. Shown below are examples of printouts of readings with tolerance limits disabled (Fig. 8-3) and with tolerance limits enabled (Fig. 8-4):

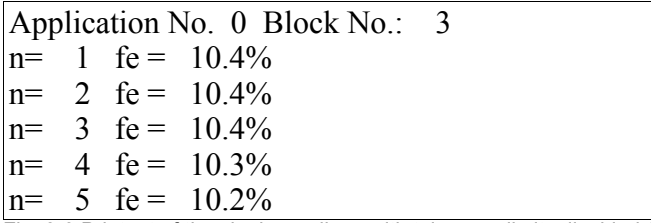



Fig. 8-3 Printout of the single readings with tolerance limits disabled (example)

Application No. 0		Block No.: 3	
n	LSL		USL
	10.2%		10.8%
1	*		10.4
2	*		10.4
3	*		10.4
4	*		10.3
5	<<		10.2

Fig. 8-4 Printout of the single readings with tolerance limits enabled (example)

If you change during the display of the block result of the current block to the block result of a previous block (by pressing ∇), then the block result of this block can be printed as well using **PRINT**. The printout will then include a list of the readings of this block as well.

8.1.3 Computed parameters - Block result

FISCHER FERIT-SCOPE FMP30	Instrument type:
2008-07-25	Current date
Appl. No.	Application name/Application number (appears only if a designation has been assigned ( 5.5 'Assigning Application Designations', beginning on Page 52)
-- Block result --	Result type
Block No.	Current measurement block number/block name (appears only if a designation has been assigned  5.5 'Assigning Application Designations', beginning on Page 52)
Date Time	Date and time of the last measurement of the evaluated block or closed block, respectively
Mean value Fe.	Mean value with a confidence interval of 95%
Std. dev. s	Standard deviation
n	in the list of the readings: Sequential number of the reading in the block result: Number of the evaluated readings
COV	Coefficient of variation

Lowest value	Lowest block mean value (Minimum)
Highest value	Highest block mean value (Maximum)
LSL/USL	Upper / lower specification limit
*	Reading is within the tolerance limits
<< / >>	Reading violates the tolerance limits
!//!	The measurement was recognized as an outlier



With the Matrix measuring mode enabled (indicated by  on the LCD display), the block result will **not** be printed by pressing **BLOCK-RES**. In the Matrix measuring mode, the block result can be printed only later by using the **PRINT** command.

8.2 Evaluation of the Open Application “Final Result”





The final result combines the results of the evaluation of all readings contained in the open Application.

Taking a new measurement or pressing the **ENTER** key during the evaluation of the open Application ends the final result display.

When making measurements with a fixed block size and the last block has not been concluded, the next reading will be added to this block (even if **ENTER** is used to end the evaluation). In this case, the block will be concluded only after the number of readings in this block corresponds to the set block size ( 7.3.6 ‘Measurements With a Fixed Block Size’, beginning on Page 94).



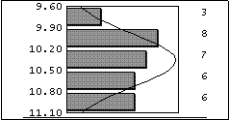

When making measurements with a fixed block size, only the measurements of the closed blocks will be included in the evaluation of the open Application.

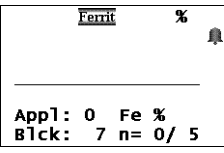
Key sequ. / Action	Detail of the LCD display	Explanation
FINAL-RES	<pre> App1: 0 nbl = 6 fe. = 10.43 % σ^A = 0.04 % COVA= 0.35 % </pre>	Use FINAL-RES to start the evaluation of the open Application.
	<pre> sm.B= 10.40 % lg.B= 10.43 % R. = 0.08 % <LSL= 0 >USL= 0 </pre>	[Page: FINAL-RES]: Pressing FINAL-RES again: Displays additional computed quantities.
	<pre> cp = 2.28 % cpk = 0.68 % </pre>	[Page: FINAL-RES]: Pressing FINAL-RES again: Displays additional computed quantities.
	<pre> App1: 0 Number of blocks Mean value Est. StdDev. σ^A Estimated cov </pre>	[Info: CAL]: Press CAL to display an explanation of the computed parameter:
	<pre> smallest block largest block Mean range n < 10.0 % n > 10.5 % </pre>	
	<pre> Proc. capability Proc. capability </pre>	<p> appears on the display when the tolerance limits are enabled.</p> <p> appears on the display once the block is closed.</p>
		Once at least 30 measurements have been taken, a histogram can be displayed as well by pressing FINAL-RES again. To do this, select: [On] () 10.3.2 'Histogram', beginning on Page 160) from Service menu/Evaluation/Histogram.
<pre> Histogram: Not enough measurements ! (min = 30) </pre>	Otherwise, the notification to the left will appear on the display.	

Key sequ. / Action	Detail of the LCD display	Explanation
FINAL-RES		<p>Notes about finishing the final result using FINAL-RES.</p> <p>[Delete meas.: DEL]: Use DEL to delete all readings of the evaluated Application.</p> <p>[Exit: ENTER]: To end the final results function without deleting the readings use ENTER.</p>
ENTER		<p>Use ENTER to finish the final result function.</p> <p>if DEL is pressed first, all readings of the evaluated Application will be deleted.</p> <p>The instrument is again ready to make measurements.</p>

8.2.1 Documenting the Final Result with a Printer

Corresponding to the settings in Service menu/Print/Final result ( 10.5.5 'Final Result', beginning on Page 168), pressing **FINAL-RES** allows for the block result of the current block to be printed with date and time stamp "automatically" or "on request" if a printer is connected and powered up.

Only if the tolerance limits are enabled will the number of measurements that are violating the lower or upper tolerance limits be specified on the printout of the final result( Fig. 8-5).

```

FISCHER FERITSCOPE FMP30      27.06.08

Product .....

Name .....
Appl.No. 0      -- Final result --
from 27.06.08 11:26 to 27.06.08 11:27

Mean value fe.= 39.84%
Est.StdDev.  $\sigma^{\wedge}$  = 1.88%
COV = 19.11%
smallest block= 8.89%
largest Block = 10.33%
    
```

Fig. 8-5 Printout of a final evaluation (example)

If tolerance limits are enabled and measurements were made with the fixed block size, additional parameters will be output ( Fig. 8-6).

```

FISCHER FERITSCOPE FMP30      27.06.08

Product .....

Name .....
Appl.No. 0      -- Final result --
from 27.06.08 11:12 to 27.06.08 11:23

Mean value fe.= 39.84%
Est.StdDev.  $\sigma^{\wedge}$  = 1.88%
COV = 19.11%
smallest Block= 8.89%
largest Block = 10.33%
  1 values < LSL ( 10.20% )= 20.00%
  0 values > USL ( 10.80% )= 0.00%
cp = 0.69 cpk = 0.34 s $^{\wedge}$  = 0.51
    
```

Displayed only when tolerance limits are enabled



Displayed only when measurements are made



Fig. 8-6 Printout of a final evaluation with fixed block size and tolerance limits enabled (example)

8.2.2 Computed Parameters - Final Result

FISCHER FERIT-SCOPE FMP30	Instrument type:
2008-06-27	Current date
Product	
Name	
Appl. No.	Number of the Application
-- Final result --	Result type
from ... to ...	Date and time of the last block closure of the first and the last block or the current date and the current time (if the last block is not yet closed).
Mean value Fe./ Fe..	Mean value/Mean value of the block mean values with a 95% confidence interval
Std dev. s	Standard deviation
Est.StdDev. σ_A	Estimated standard deviation σ_A (only specified with fixed block sizes).
n	Number of evaluated readings
ni	Block size (number of readings per block)
Std. dev. sa	Standard deviation sa (is specified only if the spread of the mean values cannot be explained from the spread within the blocks according to a variance analysis).
nBI	Number of evaluated blocks
COV	Coefficient of variation
Smallest value/ Smallest block	Lowest reading (Minimum)/ lowest block mean value
Highest value/ Highest block	Highest reading (Maximum)/ highest block mean value
LSL/USL	Upper / lower specification limit
cp / cpk	Process capability index
s [^]	Estimated value for the standard deviation

8.2.3 Histogram

A histogram ( Fig. 8-7) will be printed after the final result only if the respective histogram mode has been set up in the service functions ( 10.5.6 'Histogram', beginning on Page 169) and there are at least 30 readings stored in the Application ( 10.8 'Storage Mode', beginning on Page 187).

To determine whether the evaluated readings have normal distribution, the instrument performs a Kolmogorov-Smirnov test (if up to 40 readings are evaluated) or a χ^2 test (if more than 40 readings are evaluated) during the final evaluation. The test result is printed out under the histogram and shows if a normal distribution of the readings was determined [Normal distribution] ( Fig. 8-7) or not [No normal distribution] ( Fig. 8-8).

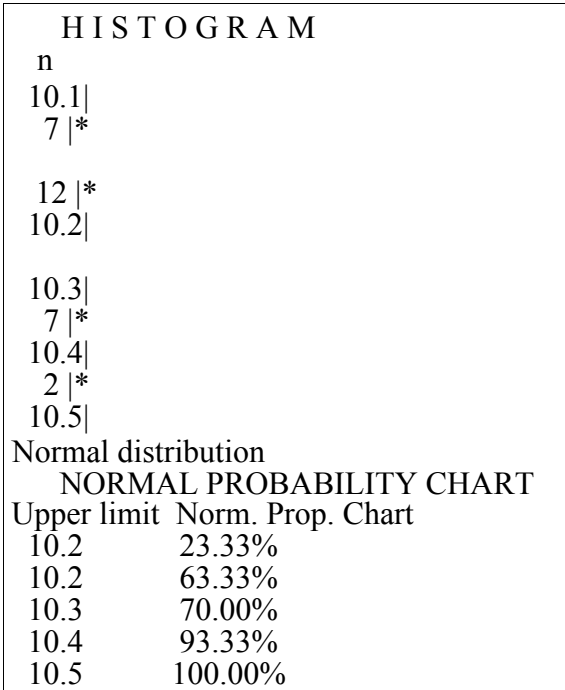

Fig. 8-7 Printout of a histogram with normal distribution (example)

Skewness and kurtosis are printed out only if the evaluated readings do not have normal distribution (with a normal distribution, skewness and kurtosis are Zero!):

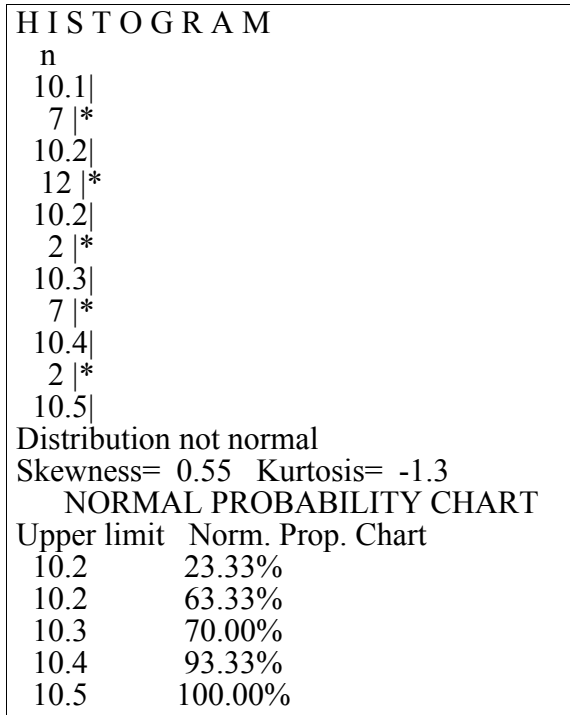

Fig. 8-8 Printout of a histogram without normal distribution (example)

9 Data Transfer Using USB



Basic computer knowledge regarding configuration, operation and programming as well as knowledge of the software in use, which may be obtained from respective instruction manuals, is required when using the instrument in conjunction with a computer.

The USB port for the instrument is on the unit's rear side. Bi-directional data exchange occurs via the USB interface.

The following operations are possible when the USB port is connected to a computer (PC):

- Transfer of the readings and the characteristic statistical data from the instrument to the PC.
- Remote control of the instrument by sending commands from the PC to the instrument.
- Requesting measurement data and other data (e.g., the name of the current Application) by sending commands from the PC to the instrument.
- Transfer of data (e.g., designations for Applications) from the PC to the instrument by sending commands from the PC to the instrument.

Both commercial or one's own data processing programs can be used to process the data exported by the instrument. Information regarding import and processing of the data using such programs may be obtained from the respective manuals for these programs.

Use the USB to

- Transfer measurement data and additional information in the ASCII format, e.g., using PC-DATEX (additional information about the PC-DATEX program is available from Helmut Fischer GmbH or your authorized system supplier.) directly into an EXCEL spreadsheet, and
- Transmit commands and data, e.g., via Windows® Hyper Terminal (only up to version Windows XP®), from the PC to the instrument.

9.1 USB Connection to a PC

Connect the USB port of the instrument with the USB port of the PC.
Use the USB cable supplied with the instrument.

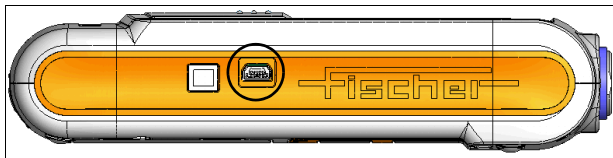

Fig. 9-1 Side view of the instrument with the USB port

9.2 Installing the USB Drivers

If there is no USB driver installed for the USB connection on your PC, proceed as follows:



If the USB driver was downloaded from a Website of Helmut Fischer GmbH: Before installing the driver, extract the downloaded driver file into a folder on your PC (e.g., C:\Programme\USB-Treiber\FMP-USB).

1. Connect the instrument to the USB port of your PC. The “Found New Hardware Wizard” opens.
2. Follow the instructions of the Windows wizard. If the driver is not found automatically, select or enter the source to search for the USB driver (e.g., CD-ROM drive, removable media (CD, diskettes, ...) or local path).



Windows XP®:

Ignore the message for the Windows Logo Test (Window “Hardware Installation”). Click the Continue Installation button and continue the installation.





The successful installation of the USB driver can be verified in the Windows Device Manager.

- Open the Device Driver: Start/Control Panel/System, Hardware tab, Device Manager button.
- You will find an additional COM port under “Ports (COM & LPT)”, e.g., USB Driver for FMP (COM3) if the instrument is connected to your PC via the USB interface.

9.3 Transfer of the Measurement Data to the Computer





Knowledge regarding operation of the computer and the software in use, which may be obtained from respective instruction manuals, is required.

1. Establish the USB connection:  Page 139.
2. Select the data for online export:  10.6 ‘Instrument Mode’, beginning on Page 171.
3. Data transfer from the instrument to the PC
.. during the measurement (online operation):  9.3.1,
.. after the measurement (offline operation)  Page 141.
4. Control the instrument from the PC:  Page 142.

9.3.1 Online Operation

For transferring measurement data during online operation, the instrument is connected to the computer during the measurement and the data are output immediately (online) via the USB port.

If the setting in the service function is “USB/Output/Individual Values”, the single readings are output immediately following the measurement acquisition via the USB port.

If, on the other hand, the setting is “USB/Output/Block mean values”, the block mean values are output via the USB port after pressing **BLOCK-RES** ( 8.1 ‘Evaluation of the Current Block “Block Result”’, beginning on Page 125); the single readings will be displayed but will not be output. Setting the type of transferred measurement data:  10.6 ‘Instrument Mode’, beginning on Page 171.

9.3.2 Offline Operation

With offline operation, the data stored in the instrument are output at a later time (offline) via the USB port. The data output is triggered by pressing **PRINT**.

If the setting in the service function is “USB/Output/Individual Values”, the single readings are output via the USB port after pressing **PRINT**.

If, on the other hand, the setting is “USB/Output/Block mean values”, only the block mean values are output via the USB port.

Setting the type of transferred measurement data:  10.6 ‘Instrument Mode’, beginning on Page 171

9.3.3 Transferring Data With a Group Separator

A sequence of single readings can be combined into a block by pressing **BLOCK-RES** ( 8.1 ‘Evaluation of the Current Block “Block Result”’, beginning on Page 125). For transferring data, a group separator (ASCII GS) can be used to identify the end of an individual blocks that have been created by pressing **BLOCK-RES**.

The groups separator is placed at the end of each a block and output via the USB port followed by CR+LF only if the setting in the service function “USB/Group separator” is set to [on] (Group separator [on] is the factory default setting)

 10.6 ‘Instrument Mode’, beginning on Page 171.

9.4 Transmission from the PC to the Instrument

9.4.1 Transfer Formats

- All input and output data are transferred as ASCII-Strings followed by a CR and a LF control character (Carriage Return Line Feed; CR = ASCII13, LF = ASCII10).
- The max length of data received by the instrument is 20 characters.

9.4.2 Control Commands

The instrument can be remote controlled and can request readings and other data by sending the control commands from the PC to the instrument. The requested readings or the data, respectively, are then transmitted by the instrument via the USB port and received by the PC.

If sending the commands “**DAM**”, “**DAT**”, “**GAN**”, “**GBN**”, “**SAN**”, “**SBN**”, “**SGS**” or “**SWA**” results in an error, i.e., the respective function cannot be executed, the instrument will return the ASCII character „NAK” via the USB port to the computer.







Response: ACK (ASCII6)

Response in case of an error: NAK (ASCII21)

Command	Function
STATE	Requests information on the current state of the instrument. “1” is output if the instrument is ready to make measurements. “0” is output if the current Application has not been set up. “-1” is output for any other state (e.g., if the service functions are called at the particular time).
G0 or ES or EN or ESC?	Triggers the measurement acquisition Measurement data are output by the instrument via the USB port.
XX or z	Requests the current count rate Outputs the current count rate but does not store it in the instrument.
XN or y	Requests the current normalized count rate. Outputs the current normalized count rate, but does not store it in the instrument.
SAM	Requests all measurement data that are stored in the current application.
DAM0 ... DAM99	Deletes all readings that are stored in the Application with the specified number. Example: The command “DAM2” deletes all measurement data of the second Application.
PT1	Sets the measurement data output mode “Single readings without groups separator”, i.e., during measurement data output, the single readings are transferred without a group separator.

Command	Function
PT2	Sets the measurement data output mode “Single readings with group separator”, i.e., during the measurement data output, the single readings are transferred and a group separator (ASCII GS) is transmitted between each of the measurement blocks.
PT3	Sets the measurement data output mode “only block mean values”, i.e., during the measurement data output, only the block mean values are transferred.
ESC0	Operates the DEL key
ESC1	Operates the FINAL-RES key
ESC2	Operates the BLOCK-RES key
ESC3	Operates the ON/OFF key
ESC4	Operates the ZERO key
ESC5	Operates the CAL key
ESC6	Operates the ^ key
ESC7	Operates the ∨ key
ESC8	Operates the APPL No key
ESC9	Operates the MENU key
ESC:	Operates the PRINT key
ESC;	Operates the ENTER key
AN	Requests the maximum possible number of Applications that can be set up in the instrument.
GAA	Requests the number of the current Application.
SWA0 ... SWA99	Selects the Application with the number 0 (... 99) in the instrument. Example: The result of the command “SWA2” is that the Application with the number 2 is selected in the instrument.
IEX0 ... IEX99	Checks if the Application with the number 0 (... 99) is set up in the instrument. The instrument outputs “1” if the Application is set up and “0” if it is not set up.

Command	Function
GAN0 ... GAN99	Requests the designation of the Application with the number 0 (...99). An empty string is output if no designation has been assigned. Assign a designation using the software MPNAME or the command "SAN". Example: After receiving the command "GAN2", the instrument outputs the name of the second Application.
SAN0 ... SAN99	Assigns a designation for the Application with the number 0 (...99). After receiving the command "SAN", the instrument sends the ASCII character "ACK". The transfer of the designation that the Application is to receive must occur directly thereafter. The designation must finish with CR+LF as well and may contain a maximum of 16 ASCII characters. After receiving the designation, the instrument sends the ASCII character "ACK". Example: The command "SAN2", followed by the desired designation assigns a new designation to the second Application.
GBN0 ... GBN999	Requests the designation of the measurement block with the number 1 (...1000). An empty string is output if no designation has been assigned. Assign a designation using the software MPNAME or the command "SAN". Example: After receiving the command "GBN2", the instrument outputs the designation of the third block of the current Application.
SBN0 ... SBN999	Assigns a designation for the Application with the number 1 (...1000). After receiving the command "SBN", the instrument sends the ASCII character "ACK". The transfer of the designation that the block is to receive must occur directly thereafter. The designation must finish with CR+LF as well and may contain a maximum of 16 ASCII characters. After receiving the designation, the instrument sends the ASCII character "ACK". Example: The command "SBN2" assigns a designation to the third block of the current Application. Blocks can receive designations only when the Matrix measuring mode is enabled. You can use the command "GMX" to query if a the Matrix measuring mode is enabled. Enabling the Matrix measuring mode:  10.6.3 'Matrix Mode', beginning on Page 174.
DAT0 ... DAT999	Requests the date and time of the block closure of the block with the number 1 (...1000). Example: The command "DAT2" outputs the date and time of the block closure of the third block of the current Application.

Command	Function
GNB	Requests the number of measurement blocks that are stored in the current application.
GG	Requests the block size of the current Application, i.e., the number of readings that are to be combined during automatic block creation. "0" is output of automatic block creation is disabled. Enables automatic block creation and sets the block size of the current Application:  5.6.3 'Automatic Block Size and Block Creation', beginning on Page 57.
GMX	Requests the measuring mode. The instrument outputs "1" if the Matrix mode is enabled. A "0" output indicates that the standard measuring mode is enabled. Enabling the Matrix measuring mode:  10.6.3 'Matrix Mode', beginning on Page 174.
GGs	Requests the group separator mode. The instrument outputs "1" if group separator is enabled (i.e., a group separator is transmitted between each measurement block during the output via the USB port). "0" is output if the group separator is disabled. Setting the group separator mode: Command "SGS1" or  9.3.3 'Transferring Data With a Group Separator', beginning on Page 141.
SGS0	Disables the group separator in the instrument. If the group separator is disabled, no group separator will be transmitted between the individual measurement blocks during the output via the USB port.
SGS1	Enables the group separator in the instrument. If the group separator is disabled, a group separator will be transmitted between the individual measurement blocks during the output via the USB port.
PE	Requests the ASCII character that the instrument uses as the group separator. The instrument outputs "GS" via the USB port.
SER	Requests the serial number of the instrument.
VV	Requests the version designation of the instrument internal software (e.g., RBA12)

9.5 Connecting a Printer

- Connect the USB port of the instrument with the USB port of the Printer. Use the USB cable supplied with the instrument.

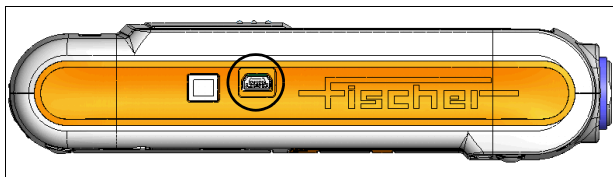



Fig. 9-2 Side view of the instrument with the USB port

- You can obtain an overview of printers that are suitable for connection to the instrument from the Helmut Fischer GmbH Institute for Electronics and Metrology or from your authorized supplier.













For information about operation, maintenance and care of the printer, consult the instruction manual of the printer.

- Information regarding the instrument settings for printing:
 10.5 'Printing', beginning on Page 164.

9.5.1 Print Output



Printing is possible from the following situations:

- Documenting the set up Applications ( Page 50),
- Documenting the normalization ( Page 70), corrective calibration ( Page 76), calibration on coating ( Page 77) and master calibration ( Page 84),
- Output of the block result after the closing the block ( Page 94),
- Output of the single readings after measurement acquisition ( Page 98),
- Evaluation of the blocks using BLOCK RES ( Page 128),
- Final evaluation of the measurement data using FINAL RES ( Page 133),
- Output of the instrument configuration ( Page 188).

10 Instrument Settings - Service Function Menu

The instrument settings described below are configured from the Service function menu.

How to access the “Service function” menu:

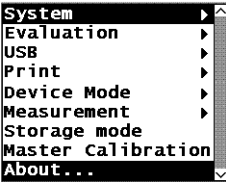
Key sequ. / Action	Detail of the LCD display	Explanation
ON/OFF 5 x ENTER		Use ON/OFF to turn the instrument on After pressing ENTER 5 times, the identification number 157 appears on the LCD display.
2 x ^		Enter the identification number 159 by pressing the arrow key ^ 2 times. Use ENTER to confirm the setting.
ENTER		The Service settings menu will be displayed. Press the arrow keys ^ or v to select the desired service function.

How to exit the “Service functions” menu:

Key sequ. / Action	Explanation
DEL	Press the DEL key to exit the Service functions menu. The instrument is ready to make measurements.

The default settings of the service function parameters (i.e., the as shipped factory settings) are underlined below(e.g., [Histogram off]). A re-initialization will reset the settings in the service functions to the default settings (📄 Page 157). However, time, date and language are not reset by the re-initialization!



The descriptions below assume that the service functions have been retrieved and not yet exited.

10.1 Service Menu Overview

Service menu	Functions	start on Page
System	Language	149
	Time	150
	Datum	151
	Date format	152
	Contrast	153
	Light	154
	Auto switch off	156
	Initialization	157
Evaluation	Block result	159
	Histogram	160
USB	Output to port	161
	Group separator	162
	Send in free	163
Print	Printer	164
	left margin	165
	Print sgl. meas.	166
	Block result	167
	Final result	168
	Histogram	169
	Auto formfeed	170
Device Mode	Restricted mode	171
	Analog display	173
	Matrix mode	174
	Linking	177

Service menu	Functions	start on Page
Measurement	Audible signal	178
	Meas. signal	179
	Extern start	180
	Measuring Mode - Standard/ Area Measurement/Auto Measurement	182
	Unit	184
	Measured variable	185
Storage mode	store/do not store/delete at off	187
Master calibration	Performing a master calibration	187
About ...	Information about the instrument configura- tion	188

10.2 System

10.2.1 Language



Do not select a language for which you do not understand the characters, e.g., Cyrillic! You might have difficulty returning to a language that is familiar to you!

Key sequ. / Action	Detail of the LCD display	Explanation
		Select System from the service menu. Use ENTER to confirm the selection.
ENTER		Select the Language by pressing the arrow key \wedge or \vee and confirm the selection with ENTER .

Key sequ. / Action	Detail of the LCD display	Explanation
ENTER		Select the desired language by pressing the arrow keys \wedge or \vee and confirm the selection with ENTER .

10.2.2 Time

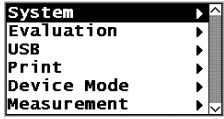
Key sequ. / Action	Detail of the LCD display	Explanation
		Select System from the service menu. Use ENTER to confirm the selection.

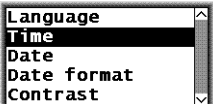



ENTER		Select the Time by pressing the arrow key \wedge or \vee and confirm the selection with ENTER .
-------	---	---

ENTER		Set the current time (hours) by pressing the arrow keys \wedge or \vee and confirm the setting with ENTER .
-------	---	--



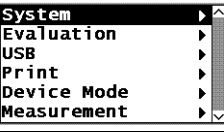
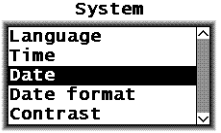

		Set the current time (minutes) by pressing the arrow keys \wedge or \vee and confirm the setting with ENTER .
--	---	--

You will be returned to the **System** menu. Use **DEL** at any time to cancel the setting procedure.

10.2.3 Date

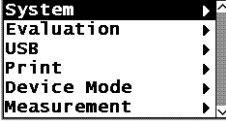

Key sequ. / Action	Detail of the LCD display	Explanation
		Select System from the service menu. Use ENTER to confirm the selection.
ENTER		Select the Date by pressing the arrow keys \wedge or \vee and confirm the selection with ENTER .
ENTER	<div style="text-align: center;"> <p data-bbox="378 592 426 635">Date day</p>  </div> <div style="text-align: center;"> <p data-bbox="378 794 426 837">Date month</p>  </div> <div style="text-align: center;"> <p data-bbox="378 927 426 970">Date year</p>  </div>	<p>Set the current date (day) by pressing the arrow keys \wedge or \vee and confirm the setting with ENTER. The order for displaying day, month and year depends on the selected "date format" (☐ 10.2.4).</p> <p>Set the current date (month) by pressing the arrow keys \wedge or \vee and confirm the setting with ENTER.</p> <p>Set the current date (year) by pressing the arrow keys \wedge or \vee and confirm the setting with ENTER.</p> <p>Use DEL at any time to cancel the setting procedure.</p>

10.2.4 Date format

Key sequ. / Action	Detail of the LCD display	Explanation
		<p>Select System from the service menu. Use ENTER to confirm the selection.</p>
ENTER	<p style="text-align: center;">System</p> 	<p>Select the Date format by pressing the arrow key \wedge or \vee and confirm the selection with ENTER.</p>
ENTER	<p style="text-align: center;">Date format</p>  <p style="text-align: center;">Date format</p> 	<p>[european]: Date format dd.mm.yy</p> <p>[USA]: Date format mm.dd.yy</p> <p>Use DEL at any time to cancel the setting procedure.</p>

10.2.5 Contrast

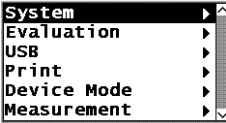

Use the contrast setting to adjust the LCD display brightness continuously. The contrast value can be between 0 (brightest LCD display) and 99 (darkest LCD display). The default contrast setting is 60.

Key sequ. / Action	Detail of the LCD display	Explanation
		Select System from the service menu. Use ENTER to confirm the selection.
ENTER		Select the Contrast by pressing the arrow key \wedge or \vee and confirm the selection with ENTER .
ENTER \wedge or \vee		Use ENTER to confirm the “Contrast” selection, or specify a new value by pressing the arrow keys \wedge or \vee , then confirm the entry with ENTER . Use DEL at any time to cancel the setting procedure.

10.2.6 Lighting



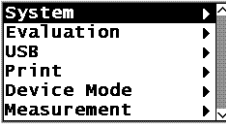
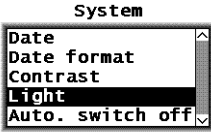

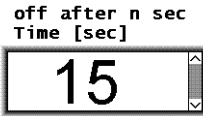
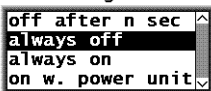
The following options are available for the light setting”

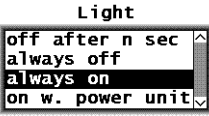
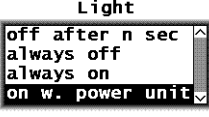
- “off after n sec”: The light turns off after n seconds.
- “always off”: The light is always off.
- “always on”: The light is always turned on.
- “on w. power unit”: The light is on only with the power unit connected.

Key sequ. / Action	Detail of the LCD display	Explanation
		Select System from the service menu. Use ENTER to confirm the selection.
ENTER		Select Light by pressing the arrow keys \wedge or \vee and confirm the selection with ENTER .
ENTER		Select the desired setting by pressing the arrow keys \wedge or \vee . Use ENTER to confirm the desired setting. Use DEL at any time to cancel the setting procedure.
\wedge or \vee Enter		off after n sec Use ENTER to confirm the value, or: specify a new value by pressing the arrow keys \wedge or \vee . Pressing ENTER returns you to the menu in order to enter additional settings.
\wedge or \vee Enter		always off After confirming the selection “always off” with ENTER you are immediately returned to the menu in order to enter additional settings.

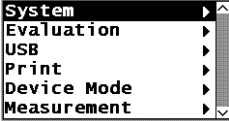
Key sequ. / Action	Detail of the LCD display	Explanation
^ or v Enter	 <p>The LCD display shows the 'Light' menu with four options: 'off after n sec', 'always off', 'always on', and 'on w. power unit'. The 'always on' option is highlighted with a black background and white text.</p>	always on After confirming the selection “always on” with ENTER , you are immediately returned to the menu in order to enter additional settings.
^ or v Enter	 <p>The LCD display shows the 'Light' menu with four options: 'off after n sec', 'always off', 'always on', and 'on w. power unit'. The 'on w. power unit' option is highlighted with a black background and white text.</p>	on w. power unit After confirming the selection “on w. power unit” with ENTER , you are immediately returned to the menu in order to enter additional settings.

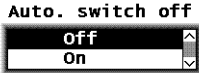
10.2.7 Automatic Switch Off

Key sequ. / Action	Detail of the LCD display	Explanation
		Select System from the service menu. Use ENTER to confirm the selection.
ENTER		Select Auto. switch off by pressing the arrow keys \wedge or \vee and confirm the selection with ENTER .
ENTER		Select the desired mode by pressing the arrow keys \wedge or \vee and confirm the selection with ENTER .
		[off]: The instrument does not switch off automatically. The switch-off mode is disabled.
		[on]: The instrument shuts down automatically if for about 5 minutes no measurements are made or no key is pressed. The switch-off mode is enabled.
		Use DEL at any time to cancel the setting procedure.

10.2.8 Re-Initialization of the Instrument

The restoration of the default settings of the instrument is called re-initialization. With a re-initialization of the instrument,

- all Applications are deleted, i.e., the stored measurement data as well as the normalizations and the corrective calibrations of all Applications (thus, after a re-initialization, all Applications must be set up anew!),
- all readings are deleted,
- all settings in the service functions are reset to the default settings (i.e., to the factory settings) (with the exception of time, date and language); thus, if necessary the settings will have to be made again,
- all settings in the service functions are reset to the default settings (i.e., to the factory settings) (exception: language); thus, if necessary the settings will have to be made again,
- the coefficients of the master characteristic that is stored in the EEPROM of the probe plug are not changed because the re-initialization concerns only the memory of the instrument.

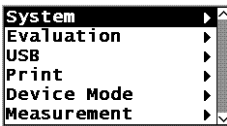
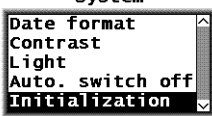
Key sequ. / Action	Detail of the LCD display	Explanation
		Select System from the service menu. Use ENTER to confirm the selection.
ENTER		Select the Initialization by pressing the arrow keys \wedge or \vee and confirm the selection with ENTER .
ENTER	<p>Initialize unit? ATTENTION: All Readings and Settings will be deleted! Yes:DEL No:ENTER</p>	<p>[Yes: DEL]: Press DEL to carry out the re-initialization.</p> <p>[No: ENTER]: Press ENTER to not carry out the re-initialization.</p>



Press DEL only if the re-initialization is indeed desired!

DEL



**Initialization
finished
successfully!**

[Continue: ENTER]: Press **ENTER** will return you to the System menu.

Continue: ENTER



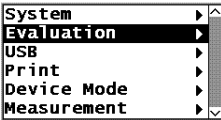

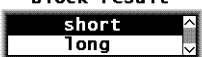
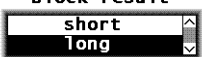
10.3 Evaluation

10.3.1 Block Result

Key sequ. / Action	Detail of the LCD display	Explanation
		Select Evaluation from the service menu. Use ENTER to confirm the selection.
ENTER		Select Block Result by pressing the arrow keys \wedge or \vee and confirm the selection with ENTER .
		[short] : Output of the short block result in the printout.
		[long] : Output of the long block result in the printout.
		Use DEL at any time to cancel the setting procedure.

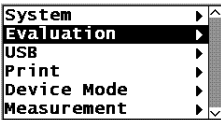
10.3.2 Histogram

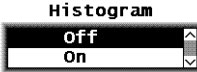
A histogram can be presented as well when the final result is displayed.() 8.2 'Evaluation of the Open Application "Final Result"', beginning on Page 131. At least 30 readings are required for this. To display the histogram, proceed as follows:



Key sequ. / Action	Detail of the LCD display	Explanation
		Select Evaluation from the service menu. Use ENTER to confirm the selection.
ENTER		Select Histogram by pressing the arrow keys U or U and confirm the selection with ENTER .
		[off]: No histogram output when displaying the final result.
		[on]: Histogram output when displaying the final result.
		Use DEL at any time to cancel the setting procedure.



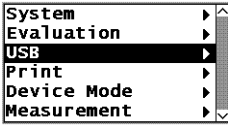

For print settings of the histogram display proceed as described under 10.5.6 'Histogram', beginning on Page 169.

10.4 USB

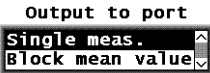
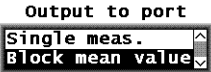
10.4.1 Output

Key sequ. / Action	Detail of the LCD display	Explanation
		<p>Select USB from the service menu. Use ENTER to confirm the selection.</p>
ENTER	<p style="text-align: center;">USB</p> 	<p>Select the desired output mode by pressing the arrow keys ^ or v and confirm the selection with ENTER.</p>
		<p>[Single meas.]: Single reading output via the USB port.</p>
		<p>[Block mean value]: Block mean value output via the USB port.</p>
		<p>Use DEL at any time to cancel the setting procedure.</p>

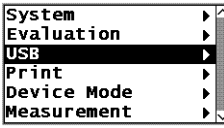
10.4.2 Group Separator

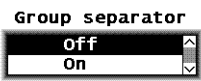
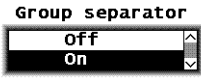
Key sequ. / Action	Detail of the LCD display	Explanation
		Select USB from the service menu. Use ENTER to confirm the selection.
ENTER	  	Select the desired groups separator mode by pressing the arrow keys \wedge or \vee and confirm the selection with ENTER . [off] : No group separator will be transmitted between the individual blocks during the output via the USB port. [on] : A group separator (ASCII29) will be transmitted between the individual blocks during the output via the USB port. Use DEL at any time to cancel the setting procedure.

10.4.3 Send Free-Running Mode

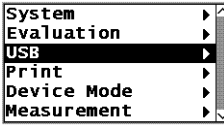
Key sequ. / Action	Detail of the LCD display	Explanation
		Select USB from the service menu. Use ENTER to confirm the selection.

ENTER



Select the desired free-running mode by pressing the arrow keys \wedge or \vee and confirm the selection with **ENTER**.

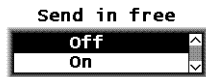

[off]: Measurement data that have been taken using the “free-running” display mode will not be transmitted via the USB port.

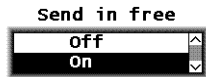



[on]: Measurement data that have been taken using the “free-running” display mode will be transmitted via the USB port.

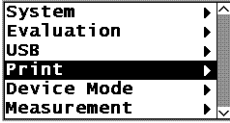

Use **DEL** at any time to cancel the setting procedure.

10.5 Printing



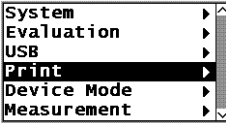

10.5.1 Printer Selection

Key sequ. / Action	Detail of the LCD display	Explanation
		<p>Select Print from the service menu. Use ENTER to confirm the selection.</p>
ENTER	<p style="text-align: center;">Printer</p> 	<p>Select the Printer by pressing the arrow key ^ or v and confirm the selection with ENTER.</p>
ENTER	<p style="text-align: center;">Print</p> 	<p>Select the desired printer by pressing the arrow keys ^ or v and confirm the selection with ENTER.</p> <p>Use DEL at any time to cancel the setting procedure.</p>

10.5.2 Left Margin Setting

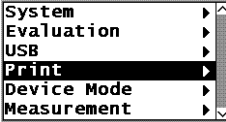





Key sequ. / Action	Detail of the LCD display	Explanation
		Select Print from the service menu. Use ENTER to confirm the selection.
ENTER		Select Left Margin by pressing the arrow key Ū or Ū and confirm the selection with ENTER .
ENTER		Enter the value for the left margin width using the arrow keys ^ or v and confirm the entry with ENTER . Use DEL at any time to cancel the setting procedure.

10.5.3 Print Individual Single Readings

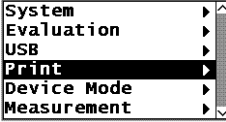
Key sequ. / Action	Detail of the LCD display	Explanation
		Select Print from the service menu. Use ENTER to confirm the selection.
ENTER	<p style="text-align: center;">Printer</p> 	Select Print sgl. meas. by pressing the arrow keys ^ or v and confirm the selection with ENTER .
ENTER		Select the desired single reading mode by pressing the arrow keys ^ or v and confirm the selection with ENTER .
	<p>Print sgl. meas.</p> 	[off] : The single readings will be printed only when the evaluation of the current block is performed.
	<p>Print sgl. meas.</p> 	[on] : The single readings will be printed directly after the measurement acquisition.
		Use DEL at any time to cancel the setting procedure.





10.5.4 Block Result

Corresponding to the setting, press **BLOCK-RES** ( 8.1.1 ‘Documenting the Block Result With a Printer’, beginning on Page 128) to print the block result. The following setting options exist:

Key sequ. / Action	Detail of the LCD display	Explanation
		Select Print from the service menu. Use ENTER to confirm the selection.
ENTER	<p style="text-align: center;">Printer</p> 	Select Block Result by pressing the arrow keys \wedge or \vee and confirm the selection with ENTER .
ENTER	<p>Automatic Print (Block result)</p>  <p>Automatic Print (Block result)</p>  <p>Automatic Print (Block result)</p>  	<p>Select the desired mode for printing the block result by pressing the arrow keys \wedge or \vee and confirm the selection with ENTER.</p> <p>Use DEL at any time to cancel the setting procedure.</p> <p>[off]: The block result is not printed.</p> <p>[on]: The block result will be printed automatically after pressing BLOCK-RES.</p> <p>[always ask]: Upon request, the block result will not be printed.</p> <p>[Yes: DEL]: Press DEL to print the block result.</p> <p>[No: ENTER]: Press ENTER to not print the block result.</p>

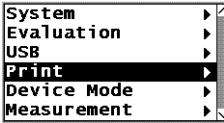

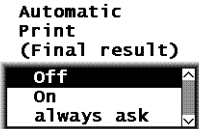
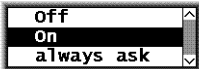

10.5.5 Final Result

Corresponding to the setting, press **FINAL-RES** (☰ 8.2.1 ‘Documenting the Final Result with a Printer’, beginning on Page 133) to print the FINAL result. The following setting options exist:



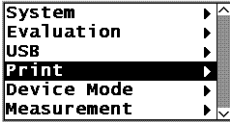

Key sequ. / Action	Detail of the LCD display	Explanation
		Select Print from the service menu. Use ENTER to confirm the selection.
ENTER		Select Final Result by pressing the arrow key U or U and confirm the selection with ENTER .
ENTER	   	Select the desired mode for printing the final result by pressing the arrow keys ^ or v and confirm the selection with ENTER . Use DEL at any time to cancel the setting procedure. [off] : The final result is not printed. [on] : The final result will be printed automatically after FINAL-RES . [always ask] : Upon request, the final result will not be printed. [Yes: DEL] : Press DEL to print the final result. [No: ENTER] : Press ENTER to not print the final result.

10.5.6 Histogram

A histogram can be added to the printout of the final result if at least 30 readings are stored in the Application (☰ 8.2.3 ‘Histogram’, beginning on Page 136).

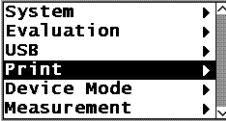
Key sequ. / Action	Detail of the LCD display	Explanation
		Select Print from the service menu. Use ENTER to confirm the selection.
ENTER		Select Histogram by pressing the arrow keys U or Ū and confirm the selection with ENTER .
		Select the desired histogram mode by pressing the arrow keys ^ or v and confirm the selection with ENTER . [off] : Histogram printout is not enabled
		[on] : A histogram presentation is printed following the printout of the final result.
		Use DEL at any time to cancel the setting procedure.

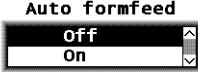
10.5.7 Auto Formfeed

Key sequ. / Action	Detail of the LCD display	Explanation
		Select Print from the service menu. Use ENTER to confirm the selection.
ENTER		Select Auto Formfeed by pressing the arrow keys \wedge or \vee and confirm the selection with ENTER .
		Select the desired Auto Formfeed mode by pressing the arrow keys \wedge or \vee and confirm the selection with ENTER . [off] : Auto Formfeed is not enabled
		[on] : The printer performs an automatic form feed. Turn Auto Formfeed on when there are problems ejecting pages. Also observe the hints in your printer manual!
		Use DEL at any time to cancel the setting procedure.

10.6 Instrument Mode

10.6.1 Restricted Operating Mode

When the restricted operating mode is enabled, only the keys necessary for measurement and evaluation are active. This avoids erroneous measurements due to unintentional adjustments of instrument parameters.

The following keys are active in the restricted operating mode:

- ZERO
- CAL
- MENU

No actions are triggered and the LCD display will not change when pressing these keys while in restricted operating mode.



Furthermore, setting up, overwriting and deleting of Applications is not possible while in the restricted operating mode!



As long as the restricted operating mode is enabled, the LCD display will show .

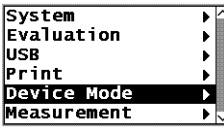
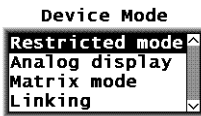

The restricted operating mode will remain enabled even after the instrument is switched off and on.

Key sequ. / Action	Detail of the LCD display	Explanation
		Select Instrument Mode by pressing the arrow keys \wedge or \vee and confirm the selection with ENTER .
ENTER		Select Restr. Mode by pressing the arrow key \wedge or \vee and confirm the selection with ENTER .

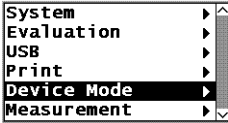
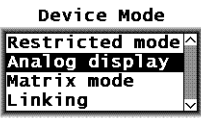
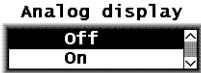
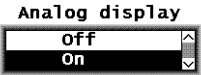

Key sequ. / Action	Detail of the LCD display	Explanation
		<p>Select the desired operating mode by pressing the arrow keys \wedge or \vee and confirm the selection with ENTER.</p>
	<p>Restricted mode</p> 	<p>[off]: The restricted operating mode is disabled, i.e., all functions are enabled according to their settings.</p>
	<p>Restricted mode</p> 	<p>[on]: The restricted operating mode is enabled.</p> <p>Use DEL at any time to cancel the setting procedure.</p>

10.6.2 Analog Display

When making measurements in the “free-running” display mode, the analog display facilitates a quick recognition of tendencies in the ferrite content changes. If analog display is enabled and measurements are made in the “free-running” display mode, the analog display with the set limits will appear in place of the information lines. The reading will appear between the limits as an analog bar.

Key sequ. / Action	Detail of the LCD display	Explanation
		Select Instrument Mode by pressing the arrow keys \wedge or \vee and confirm the selection with ENTER .
ENTER		Select Analog Mode by pressing the arrow keys \wedge or \vee and confirm the selection with ENTER .
ENTER		Select the desired display mode by pressing the arrow keys \wedge or \vee and confirm the selection with ENTER .
		[off] : Analog display disabled
		[on] : Analog display enabled, i.e., when making measurements in the “free-running” display mode, an analog bar will appear in the information lines to indicated the measured value ( 7.6.3 ‘Analog Display’, beginning on Page 107).
		Use DEL at any time to cancel the setting procedure.

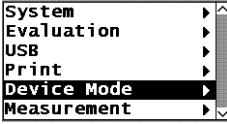

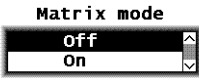
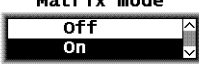
10.6.3 Matrix Mode

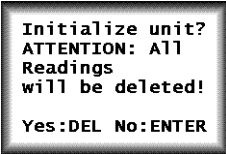
Key sequ. / Action	Detail of the LCD display	Explanation
		Select Instrument Mode by pressing the arrow keys \wedge or \vee and confirm the selection with ENTER .
ENTER		Select the Matrix Mode by pressing the arrow keys \wedge or \vee and confirm the selection with ENTER .
ENTER		<p>This settings option appears only when “dual method” both is set for all Applications set up with dual probes (📄 Page 187).</p> <p>Select the desired mode by pressing the arrow keys \wedge or \vee and confirm the selection with ENTER.</p>
		[off] : matrix mode is disabled, i.e., the standard measuring mode is enabled
		<p>[on]: Matrix measuring mode is enabled [10/20/150]: Example for 10 Applications each with 20 blocks of 150 measurements each.</p> <p>Use DEL at any time to cancel the setting procedure.</p>

Key sequ. / Action	Detail of the LCD display	Explanation
Enter		<p>When changing to a different measuring mode, the instrument will be re-initialized (see 10.2.8 'Re-Initialization of the Instrument', beginning on Page 157).</p> <p>[Yes: DEL]: Press DEL to carry out the re-initialization.</p> <p>[No: ENTER]: Press ENTER to not carry out the re-initialization.</p>



Press DEL only if the re-initialization is indeed desired!

Key sequ. / Action	Detail of the LCD display	Explanation
DEL	<p>Number of fixd. applications</p>  <p>Number of blocks per application</p> 	<p>After the re-initialization, the number of Applications and the number of blocks must be entered when changing to the matrix measuring mode.</p> <p>This automatically specifies the max. number of measurements that can be stored in one block.</p> <p>Enter the values for the number of Applications and the number of blocks by pressing the arrow keys ^ or v and confirm the respective entries with ENTER.</p>

ENTER

Select the desired block change by pressing the arrow keys \wedge or \vee and confirm the selection with **ENTER**.



[Manually]: The block change must be done manually, i.e., when making measurements in the matrix mode, the block where the next reading is to be stored can be selected freely using **BLOCK-RES** and \wedge or \vee .



[Automatic]: The block change occurs automatic, i.e., when making measurements in the matrix mode, the next measurement will be stored in the next block automatically.

Use **DEL** at any time to cancel the setting procedure.



 appears on the LCD display as long as the Matrix measuring mode is enabled.



The number of applications and blocks cannot be changed without a re-initialization.



With a re-initialization of the instrument, the stored measurement data as well as the normalization and the corrective calibration of all Applications will be deleted. After a re-initialization, all Applications must be set up anew!

10.6.4 Linking Applications

Key sequ. / Action	Detail of the LCD display	Explanation
--------------------	---------------------------	-------------

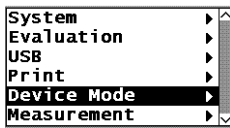

Select **Instrument Mode** by pressing the arrow keys \wedge or \vee and confirm the selection with **ENTER**.

ENTER		Select Linking by pressing the arrow key \wedge or \vee and confirm the selection with ENTER .
--------------	--	--

ENTER		<p>This settings option appears only when “dual method” is set for all Applications set up with dual probes (5 ‘Applications’, beginning on Page 45).</p> <p>Select the desired mode by pressing the arrow keys \wedge or \vee and confirm the selection with ENTER.</p>
--------------	--	--

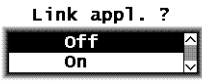

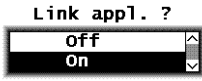

[off]: Applications are not linked to each other (linking mode disabled)



[on]: All applications that have been set up using the same probe will be linked with each other (linking mode enabled)

Use **DEL** at any time to cancel the setting procedure.

 As long as the linking mode of the Application is enabled **3-0-E** will appear on the LCD display.

 To ensure that the Applications linked to each other use the same normalization and corrective calibration, a normalization or corrective calibration, respectively, must be performed after linking for all probes for which more than one application has been set up.

10.7 Measurement

10.7.1 Audible Signal

The audible signal, i.e., the measurement acquisition signal that sounds after every measurement can be disabled.



The audible signals that sound after instrument power-up, after a tolerance limit violation, after recognition of an outlier measurement or after concluding a block (when making measurements with automatic block creation) cannot be disabled! (Details about the audible signals: 7.3.4 'Audible Signals After the Measurement Acquisition', beginning on Page 93).

Key sequ. / Action	Detail of the LCD display	Explanation
		Select Measurement by pressing the arrow key \wedge or \vee and confirm the selection with ENTER .
ENTER		Select Audible signal by pressing the arrow keys \wedge or \vee and confirm the selection with ENTER .
ENTER		Select the desired mode by pressing the arrow keys \wedge or \vee and confirm the selection with ENTER .
		[off] : No audible signal sounds when the probe is placed on the specimen.
		[on] : An audible signal sounds when the probe is placed on the specimen.
		Use DEL at any time to cancel the setting procedure.

10.7.2 Measurement Effect

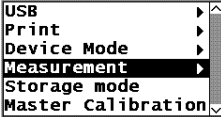
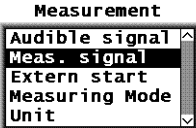
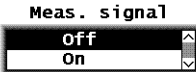
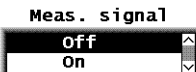
Key sequ. / Action	Detail of the LCD display	Explanation
		Select Measurement by pressing the arrow key \wedge or \vee and confirm the selection with ENTER .
ENTER		Select Meas. signal by pressing the arrow keys \wedge or \vee and confirm the selection with ENTER .
ENTER	 	Select the desired measurement effect by pressing the arrow keys \wedge or \vee and confirm the selection with ENTER . [off] : Measurement effect disabled, i.e., the reading will not be acquired automatically (automatic measurement acquisition disabled). [on] : Measurement effect enabled, i.e., the reading will be acquired automatically once the probe is placed on the specimen (automatic measurement acquisition enabled). Use DEL at any time to cancel the setting procedure.

10.7.3 External Start

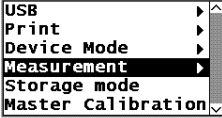
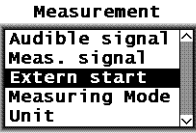
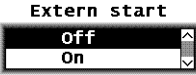
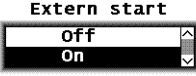

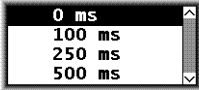
Key sequ. / Action	Detail of the LCD display	Explanation
		Select Measurement by pressing the arrow key \wedge or \vee and confirm the selection with ENTER .
ENTER		Select Extern start by pressing the arrow keys \wedge or \vee and confirm the selection with ENTER .
ENTER		Select "Extern Start on" or "Extern Start off" by pressing the arrow keys \wedge or \vee and confirm the selection with ENTER .
		[off] : External start is not possible (External start disabled)
		[on] : External start is possible (enabled), i.e., external measurement acquisition can be triggered by pressing the key \wedge (or FINAL-RES during a normalization or calibration).
		Use DEL at any time to cancel the setting procedure.





Key sequ. / Action	Detail of the LCD display	Explanation
ENTER	<p data-bbox="333 193 479 236">Extern start Delay</p> 	<p data-bbox="535 177 978 268">Select the desired “delay” by pressing the arrow keys \wedge or \vee and confirm the selection with ENTER.</p> <p data-bbox="535 304 919 331">[0 ms]: no pause after external start</p> <p data-bbox="535 376 945 459">[100 ms]: 100 ms pause after external start to</p> <p data-bbox="535 464 972 517">[2500 ms]: 2500 ms pause after external start</p> <p data-bbox="535 552 983 608">[Page \vee: CAL]: Press CAL to leaf through the pages.</p> <p data-bbox="535 639 978 695">Use DEL at any time to cancel the setting procedure.</p>

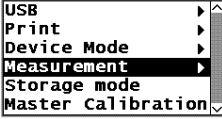
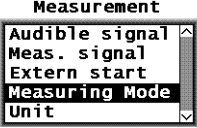
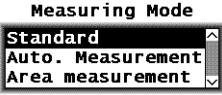

The combination “measurement effect off” and “external start off” is not permissible because it would not allow for a measurement acquisition. If this combination is set, the instrument will automatically reset the parameters to “measurement effect on” and “external start off”.



10.7.4 Measuring Mode - Standard/Area Measurement/Automatic Measurement

Key sequ. / Action	Detail of the LCD display	Explanation
		Select Measurement by pressing the arrow key \wedge or \vee and confirm the selection with ENTER .
ENTER		Select Measuring Mode by pressing the arrow keys \wedge or \vee and confirm the selection with ENTER .
ENTER		Select the desired measuring mode by pressing the arrow keys \wedge or \vee . The standard measuring mode will be enabled. Confirming with ENTER will return you to the menu for the measurement. Use DEL at any time to cancel the procedure.
		Area measurement is possible (enabled),  7.3.3 'Automatic Measurement Acquisition', beginning on Page 90. Confirming with ENTER will return you to the menu for the Measurement . Use DEL at any time to cancel the setting procedure.

Key sequ. / Action	Detail of the LCD display	Explanation
	<p style="text-align: center;">Measuring Mode</p> 	<p>Select the mode for "Automatic measurement" by pressing the arrow keys \wedge or \vee.</p> <p>Automatic measurement is possible (enabled)</p> <p> 7.3.3 'Automatic Measurement Acquisition', beginning on Page 90.</p> <p>Use ENTER to confirm the selection.</p> <p>Use DEL at any time to cancel the procedure.</p>
<p>ENTER</p>	<p style="text-align: center;">Auto. Measurement Number of Meas.</p> 	<p>Select the desired number of measurements by pressing the arrow keys \wedge or \vee and confirm the selection with ENTER.</p> <p>Use DEL at any time to cancel the setting procedure.</p>
<p>ENTER</p>	<p style="text-align: center;">Auto. Measurement Interval in sek</p> 	<p>Enter the time interval by pressing the arrow keys \wedge or \vee.</p> <p>Confirming with ENTER will return you to the menu for the Measurement.</p> <p>Use DEL at any time to cancel the setting procedure.</p>

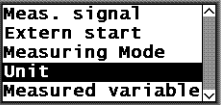
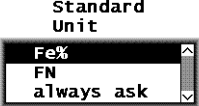
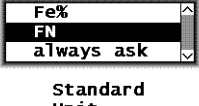

10.7.5 Unit

You can specify the unit of measurement for making measurements in the newly set up Application.

Key sequ. / Action	Detail of the LCD display	Explanation
		Select Measurement by pressing the arrow key \wedge or \vee and confirm the selection with ENTER .
ENTER		Select Unit by pressing the arrow key \wedge or \vee and confirm the selection with ENTER .
ENTER	  	<p>Select the desired unit by pressing the arrow key \wedge or \vee.</p> <p>The change of the unit does not occur until a new Application is set up.</p> <p>[Fe%]: The ferrite content display in ferrite percent.</p> <p>[FN]: The ferrite content display is in ferrite numbers.</p> <p>[always ask]: When setting up a new Application, you will be asked for the unit of measurements to be used  5.1 'Setting Up an Application', beginning on Page 45.</p>
		<p>Confirming with ENTER will return you to the menu for the measurement.</p> <p>Use DEL at any time to cancel the procedure.</p>

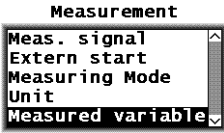
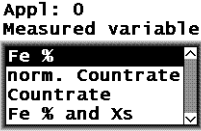

10.7.6 Measured Variable

The menu option “Measured variable” appears only when the current Application is set up.

Key sequ. / Action	Detail of the LCD display	Explanation
		Select Measurement by pressing the arrow key \wedge or \vee and confirm the selection with ENTER .
ENTER		Select Measured variable by pressing the arrow keys \wedge or \vee and confirm the section with ENTER .
ENTER		Select the measured variable of the open Application by pressing the arrow keys \wedge or \vee and confirm the selection with ENTER . The settings of the measured variables of the other Applications will not be affected.
		<p>The readings will be displayed on the LCD screen corresponding to the setting for the measured variables ( 3.3.3 ‘Measured Variables’, beginning on Page 40).</p> <p>Use ENTER to confirm the selection.</p> <p>Use DEL at any time to cancel the setting procedure.</p>

Key sequ. / Action	Detail of the LCD display	Explanation
		<p data-bbox="528 193 985 424">With every modification of the measured variable, a prompt for deleting readings already stored in the open Application will appear because it is not possible to evaluate different types of measured variables statistically at the same time. This prevents erroneous interpretations of the measurement results.</p> <p data-bbox="528 456 985 539">[Yes: DEL]: Press DEL to delete all readings already stored in the current Application.</p> <p data-bbox="528 571 985 632">[No: ENTER]: Press ENTER to cancel the procedure.</p>

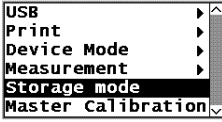
10.8 Storage Mode

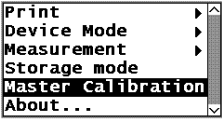

Key sequ. / Action	Detail of the LCD display	Explanation
		Select Storage mode by pressing the arrow key \wedge or \vee and confirm the selection with ENTER .
ENTER		Select the desired mode by pressing the arrow keys \wedge or \vee and confirm the selection with ENTER . [store] : The readings are stored and will be retained even after the instrument is switched off [do not store] : The readings will be displayed but not stored [delete at off] : All readings will be deleted when the instrument is switched off Use DEL at any time to cancel the setting procedure.

10.9 Performing a Master Calibration

Key sequ. / Action	Detail of the LCD display	Explanation
		Select Master calibration by pressing the arrow keys \wedge or \vee and confirm the selection with ENTER .

Performing the master calibration:  6.4 'Master Calibration', beginning on Page 77.

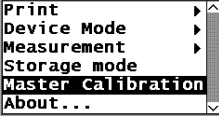
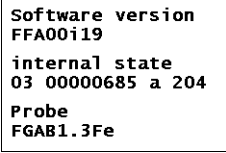
10.10 About ...

Key sequ. / Action	Detail of the LCD display	Explanation
		Select About ... by pressing the arrow key \wedge or \vee and confirm the selection with ENTER .
ENTER		Displays the software version, the internal state and the name of the connected probe. Pressing ENTER repeatedly displays the instrument configuration in succession (cf.  10.11 'Documentation of the Instrument Configuration', beginning on Page 188

10.11 Documentation of the Instrument Configuration

Key sequ. / Action	Explanation
PRINT	With the service functions retrieved and a printer connected and powered up, the documentation of the instrument configuration (including the probe) can be printed using the PRINT command ( Fig. 10-1). Using the print function also exits the service functions and the instrument is again ready to make measurements.



With the instrument powered up, an alternative method for printing the documentation is to use **MENU + PRINT**.

```

FISCHER FERITSCOPE FMP30    25.07.08
Software version   : FFA00i18
internal state    : 03 00000685 a
Probe             : FGAB1.3Fe
Serial number     : 0708V00001
Meas. range      : 0.15 - 105
Language         : english
Date format      : european
Contrast         : 71
Auto. switch off : on
Block result
Histogram        : on
Output to port   : Single meas.
Group separator  : off
Send in free    : off
Left margin     : 0
Print sgl. meas. : on
Auto Formfeed   : off
Histogram       : on
Storage mode    : off
Analog display  : on
Matrix mode     : off
Linking         : off
Audible signal  : off
Meas. signal    : on
Extern start    : on
delay          : 0 ms
Meas. mode     : standard
unit           : Fe %
Ferrite        : Fe %
Storage mode    : store
Application No. : 0
Disp. resolution : standard
Block size     : 5
Outlier reject  : off
Method         : Auto

```

Fig. 10-1 Documentation of the instrument configuration with probe-specific data (example)

11 Malfunctions and Messages

11.1 Malfunctions

Malfunction/Mes- sage	Cause	Correction	start on Page
No display	Instrument not switched on.	Use ON/OFF to turn the instrument on.	36
	Instrument switched off automatically (energy savings function during operation without AC adapter)	Use ON/OFF to turn the instrument on.	36
	Batteries are discharged (operation without AC adapter)	Replace rechargeable or regular batteries with new ones or operate the instrument with the AC adapter.	31
No display of the results with FINAL-RES	No readings in the current Application (e.g., because the measurement data have been deleted).	Take measurements.	87
No display of the results with BLOCK-RES	No readings in the current Application (e.g., because the measurement data have been deleted).	Take measurements.	87
No change on the display for ZERO, CAL or MENU	Restricted operating mode is enabled.	Use ON/OFF + ENTER to disable the restricted operating mode with the instrument switched off beforehand.	171



Malfunction/Mes- sage	Cause	Correction	start on Page
Unable to set up, overwrite or delete Applications.	Restricted operating mode is enabled.	Use ON/OFF + ENTER to disable the restricted operating mode with the instrument switched off beforehand.	171
Unable to retrieve the service functions	“Free-running” display mode is enabled.	Use \vee to disable the “free-running” display mode.	104
Probe does not measure	Measurement acquisition did not occur because the previous measurement acquisition was less than two seconds earlier.	Repeat measurement.	42
	Computing the coating thickness is not possible because the coating is too thick.	Use a different specimen.	--
	A wrong probe is connected (Application was set up with a different probe). The indicator for the measurement method flashes on the LCD display.	Connect the correct probe or assign a new probe.	33 43
	Wrong base material (measurements with magnetic induction probes are possible only on ferromagnetic base materials).	Use a specimen with a ferromagnetic base material.	--

Malfunction/Message	Cause	Correction	start on Page
Probe does not measure	Automatic measurement acquisition disabled.	Enable automatic measurement acquisition from the service functions or trigger the external measurement acquisition by pressing the ∨ key (or FINAL-RES during the normalization or calibration).	182
	Probe defective.	Use properly functioning probe.	--
Wrong readings	Probe placed on specimen incorrectly (e.g., probe hovers over specimen).	Place probe on specimen correctly and observe the minimum lift-off distance when lifting off the probe.	42
	Application selected that has not been set up for this specimen.	Use APPL No and the arrow keys to select the correct Application.	48
	Wrong base material (correct measurements with eddy current probes are possible only on non-ferromagnetic base materials).	Use a specimen with a non-ferromagnetic base material.	--
	Conducting metal close to the measurement location when making measurements using eddy current probes. (e.g., on the back side of a pc-board).	Use a specimen without a conducting metal.	--
	Incorrect normalization or calibration.	Perform a correct normalization or calibration.	67

Malfunction/Message	Cause	Correction	start on Page
Wrong readings	Wrong voltage due to connecting a wrong AC adapter (e.g., for 110 V instead of 220 V).	Connect the correct AC adapter.	11
	Probe tip worn.	Use a probe with a proper probe tip.	--
Printer prints hieroglyphics	Wrong printer setting in the instrument's service functions.	Select an appropriate printer from the service function.	171
Histogram does not print	Fewer than 30 readings are stored in the Application.	Take more than 30 measurements.	--
	Histogram output was disabled in the service function.	Enable histogram output from the service function.	187
Block result does not print automatically using BLOCK-RES	Instrument is in matrix mode (block results do not print automatically in matrix mode).	Use PRINT to print the block result.	167
Printer does not print	Printer switched off.	Turn printer on.	--
	Printer battery discharged and printer not connected to the mains power supply.	Charge printer battery or connect printer to the mains power supply.	--
	Printer not connected to the instrument.	Connect printer to the instrument.	164
	Wrong printer setting in the instrument's service functions.	Select an appropriate printer from the service function.	164
	Wrong USB cable.	Use correct USB cable.	--
	Printer or USB cable defective.	Use working printer or good USB cable.	--

11.2 Messages on the LCD Display

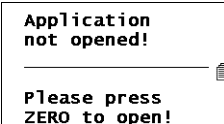
The error messages (**E*****) and warning messages (**W*****) that may occur during instrument operation are contained in the overview on the following pages.

Malfunction/Message	Cause	Correction	start on Page
	<p>Reading cannot be displayed (because the value is greater than 9999 or smaller than - 9999) Cause: Measurement carried out incorrectly.</p>	<p>Perform the measurement correctly (e.g., do not allow the probe to hover over the specimen before or after the measurement; observe the minimum lift-off distance!)</p>	42
	<p>Cause: Eddy current probe that is currently normalized on a non-ferromagnetic base material has previously been normalized on a ferromagnetic base material.</p>	<p>Continue normalization.</p>	68
	<p>Instrument is not ready to make measurements. Cause: Re-initialization was carried out. Application was deleted and then switched off.</p>	<p>Use ZERO to start and perform the normalization.</p>	68
	<p>Histogram does not print because fewer than 30 readings are stored in the current Application.</p>	<p>Take more than 30 measurements.</p>	87

Malfunction/Message	Cause	Correction	start on Page
<div style="border: 1px solid black; padding: 5px;"> <p>E 001 Math Error !</p> </div>	Instrument-internal error.	Use ON/OFF to turn the instrument off and then again on. If this error occurs repeatedly: Inform customer service.	36
<div style="border: 1px solid black; padding: 5px;"> <p>E 004 Appl. memory overflow !</p> </div>	The internal instrument memory is full.	Delete the measurement data stored in the Application or delete a complete Application.	101
<div style="border: 1px solid black; padding: 5px;"> <p>E 006 Measurements out of range !</p> </div>	Unable to display reading because it is out of the probe's measurement range.	Perform measurements on specimens with ferrite contents that can be measured with the connected probe or use a different probe.	--
	Cause: Measurement carried out incorrectly.	Perform the measurement correctly (e.g., do not allow the probe to hover over the specimen before or after the measurement; observe the minimum lift-off distance!)	42
	Cause: Measurement with eddy current probe on a non-ferromagnetic base material after a normalization on a ferromagnetic base material.	Perform a normalization with the eddy current probe on a non-ferromagnetic base material and repeat the measurement.	68

Malfunction/Message	Cause	Correction	start on Page
	Cause: ENTER was pressed during the measurement in the “free-running” display mode while the probe was lifted off.	Place the probe on the specimen and then press ENTER to trigger the measurement acquisition.	104
<div style="border: 1px solid black; padding: 5px; width: fit-content;"> <p>E 007 Measurements invalid !</p> </div>	<p>Outlier measurement recognized during normalization of calibration.</p> <p>Cause: Measurement on calibration standard carried out incorrectly.</p>	<p>Repeat the calibration step and perform the calibration measurement correctly (e.g., do not allow the probe to hover over the standard before or after the measurement; observe the minimum lift-off distance!)</p>	42
	Cause: Measurement carried out on wrong calibration standard.	Repeat the calibration step and make the calibration measurement on a correct standard.	71
<div style="border: 1px solid black; padding: 5px; width: fit-content;"> <p>E 010 Meas. method not supported !</p> </div>	Connected probe not suitable or not supported (measurement method of the connected probe does not fit the instrument).	Connect a suitable probe.	33
	Probe defective.	Connect a properly functioning probe.	33

Malfunction/Mes- sage	Cause	Correction	start on Page
<p>E 011 Measurements out of interval !</p>	<p>Unable to complete cor- rective calibration. Cause: Measurement carried out incorrectly.</p>	<p>Repeat the corrective calibration and per- form the calibration measurement correct- ly (e.g., do not allow the probe to hover over the standard before or after the measurement; observe the minimum lift-off distance!)</p>	71
	<p>Cause: Calibration standards used that did not exhibit the required ferrite content or are de- fective.</p>	<p>Repeat the corrective calibration with correct and good calibration standards.</p>	71
<p>E 012 Invalid std. sequence !</p>	<p>Calibration standards were measured out of sequence during the corrective calibration (standard 1 mixed up with standard 2) and ferrite content was not adjusted correspond- ingly using the arrow keys.</p>	<p>Repeat the corrective calibration and mea- sure the standards in the correct sequence.</p>	71
<p>E 013 Countrate out of interval !</p>	<p>Unable to complete the master calibration. Cause: Measurement carried out incorrectly.</p>	<p>Repeat the master cali- bration and perform the calibration measure- ment correctly (e.g., do not allow the probe to hover over the stan- dard before or after the measurement; ob- serve the minimum lift- off distance!)</p>	77

Malfunction/Mes- sage	Cause	Correction	start on Page
	Cause: Calibration standards used that did not exhibit the required ferrite content or are defective.	Repeat the master calibration with correct and good calibration standards.	77
<div style="border: 1px solid black; padding: 5px;"> <p>E 014 Unable to calc. parameters !</p> </div>	Instrument-internal error: Unable to compute the coefficients of the master characteristic (original master characteristic will be retained).	Repeat the master calibration. If this error occurs repeatedly: Inform customer service.	77
<div style="border: 1px solid black; padding: 5px;"> <p>E 015 Unable to store cal. in probe !</p> </div>	Unable to store master characteristic. Cause: Probe not plugged in and tightened properly.	Plug probe in and tighten properly; repeat the master calibration.	33
	Cause: Probe defective.	Connect a properly functioning probe and if applicable repeat the master calibration.	33 77
<div style="border: 1px solid black; padding: 5px;"> <p>E 016 Std. and meas. not matching !</p> </div>	The stored ferrite contents do not correspond to the measured standards. Cause: Calibration standards were measured out of sequence during the master calibration (standard 1 mixed up with standard 2) and ferrite content was not adjusted correspondingly using the arrow keys.	Repeat the master calibration and measure the standards in the correct sequence.	77

Malfunction/Message	Cause	Correction	start on Page
E 017 Not enough measurements !	Unable to generate the final result when making measurements with fixed block sizes if the first block of the evaluated Application is not closed.	Take additional measurements until the first block is concluded and re-create the final result.	125
E 021 Entered Standard invalid !	Unable to perform corrective calibration with the set ferrite content (e.g., because [Base 2: 0] was set).	Set the rated ferrite content values for the used calibration standard and continue with the corrective calibration.	71
E 022 Missing probe !	No probe connected.	Connect a probe.	33
	Probe not connected correctly.	Connect probe correctly.	33
	Probe defective.	Use properly functioning probe.	33
E 023 Meas. method different !	When overwriting an Application, it is possible to retain the measurement data only of the connected probe uses the same measurement method as the probe that was used to set up the Application.	Delete the measurement data when overwriting the Application or set up a new Application with the connected probe.	101
E 024 Result block overflow !	Unable to store the next reading in this block because the block is full (applies to matrix mode only).	Use BLOCK-RES and arrow keys to change the block.	125

Malfunction/Mes- sage	Cause	Correction	start on Page
<p>E 025 Error in application !</p>	<p>Instrument-internal er- ror.</p>	<p>Delete the faulty Appli- cation and output the measurement data via the USB port.</p> <p>([Delete Appl.? Yes:DEL N.:EN- TER]: DEL to deleted the Application. [To port? Yes: DEL N.:EN- TER], DEL to output the measurement data of this Application via the USB port to a print- er or a PC.)</p> <p>If this error occurs re- peatedly: Inform cus- tomer service.</p>	<p>101 140</p>
<p>E 029 Missing normalization or calibration !</p>	<p>Unable to compute measurement because after enabling the link- ing mode, no normaliza- tion or corrective calibration has been performed with the con- nected probe.</p>	<p>Perform a normaliza- tion or corrective cali- bration with the connected probe.</p>	<p>68 71</p>
<p>E 030 Probe damaged !</p>	<p>Probe contents does not correspond to the test value.</p>	<p>Inform customer ser- vice.</p>	<p>--</p>
<p>E 031 USB overcurrent !</p>	<p>Current consumption of a connected USB de- vice too high (max. 100 mA permitted).</p>	<p>Check and/or replace connected USB device.</p>	<p>--</p>

Malfunction/Message	Cause	Correction	start on Page
E 032 Measur. equip. not adjusted !	The measurement electronics has not been balanced properly. Because of this, measurement data may be incorrect.	Inform customer service.	--
E 033 Device damaged !	Internal write/read error.	Inform customer service.	--
E 034 Unsupported Probe format !	The probe contains an unknown data format.	Perform a software update.	--
E 035 Please perform a normalization !	Unable to compute a measurement because a normalization has not been carried out in this Application on the current base material.	Perform a normalization.	68
E 999 System error !!!	Internal instrument error.	Inform customer service.	--
w 000 Block memory overflow !	Unable to create an additional block because the maximum number of 4,000 blocks has been reached.	Delete the measurement data stored in the Application or delete a complete Application.	101 101

Malfunction/Mes- sage	Cause	Correction	start on Page
<div style="border: 1px solid black; padding: 5px;"> <p>w 001 Printer not ready !</p> </div>	Printer switched off or offline.	Turn printer on or place online and restart printing procedure.	--
	Printer not connected to the instrument.	Connect the printer and restart the printing procedure.	164
	Wrong printer setting in the service function.	Correct the printer setting in the service function and restart the print procedure.	164
<div style="border: 1px solid black; padding: 5px;"> <p>w 003 Options corrected !</p> </div>	Instrument corrected faulty settings autonomously.	--	--
<div style="border: 1px solid black; padding: 5px;"> <p>w 004 Action canceled !</p> </div>	A procedure was canceled (e.g., the corrective calibration was canceled using ENTER).	Repeat the procedure if necessary.	--
<div style="border: 1px solid black; padding: 5px;"> <p>w 005 1-Point calibration !</p> </div>	Two-point calibration performed with calibration standards with ferrite contents that are not sufficiently far apart (will be considered a one-point calibration).	Repeat the corrective calibration with suitable calibration standards. The difference of the normalized count X_n of the two calibration standards must be greater than 0.1: $X_n_{\text{Calibration standard 2}} - X_n_{\text{Calibration standard 1}}$ $\Delta X_n > 0,1$	71

Malfunction/Message	Cause	Correction	start on Page
<div style="border: 1px solid black; padding: 5px;"> <p>w 006 Probe changed !</p> </div>	<p>A probe of the same type but with a different serial number has been connected.</p>	<p>--</p>	<p>33</p>

12 FERITSCOPE® FMP30Glossary

12.1 Terms and Formula Symbols

\ \ See "Additional Literature" on Page 230.

This chapter explains the most common terms and symbols in ferrite content measurement and related fields (e.g., quality assurance). In some cases, alternate terms or synonyms are mentioned in parentheses.

χ^2 -Test  *Chi squared test (c²-Test)*

Rechargeable battery

Accumulator (German abbreviation Akku). Rechargeable. Used like any battery.





Application

Measurement Application of the User.

In the field of ferrite content measurement, an Application (memory) refers to a memory that stores the coefficients that are determined during the normalization and corrective calibration for each measurement application as well as the single readings measured in this Application. In addition, the application-specific settings are stored in the applications. Up to 100 different Applications can be created in the FERITSCOPE® FMP30.

Attributive Features  *Features*

Outlier measurements

Measurements that are considerable larger or considerable smaller than the other measurements of the measurement series and therefore can be considered as unexpected or unacceptable. With outlier rejection enabled ( Grubbs Test;  Sigma outlier rejection) the FERITSCOPE® FMP30 indicates outlier measurements by two short audible signals immediately after the measurement acquisition and the simultaneous appearance of  and  on the LCD display.

Outlier rejection

Is used to prevent the distortion of the measurement results by outlier measurements. With the FERITSCOPE® FMP30, outlier rejection can be enabled or disabled. Measurements recognized as outliers will not be included in the evaluation. Two methods are available for outlier rejection:

- Grubbs Test
- Sigma outlier rejection (Specification of a known spread)

Evaluation

Calculation of statistical parameters, e.g., mean value or standard deviation, with graphic output on the connected printer if required. With the FERITSCOPE® FMP30, the evaluation can be started using the keys **BLOCK-RES** and **FINAL-RES**. **BLOCK-RES** will start the display of the block result, **FINAL-RES** that of the final result.

B (Bit)  *Bit (Binary Digit)*

Base

Component of the calibration standard set. The Base is used for normalization and corrective calibration of the FERITSCOPE® FMP30.

Baud

Unit of the speed for transferring information (data). 1 baud corresponds to a data transfer rate of 1 bit per second.

Baud Rate

Data transfer rate. Used mainly in connection with terminal programs for data transfer. Since data are transferred via a serial port, the transfer rate is calculated in bits per second.

Bd (Baud)  **Baud**

Bidirectional data exchange (data transfer)

Data can be transmitted and received by both participants (for example, from the instrument to the PC and from the PC to the instrument).

Bit (Binary Digit)

Binary number. 1 bit is the smallest unit in the binary number system. The value of a bit is either 0 or 1. Being the smallest unit of information in a computer, a bit forms the basis of every computer system. 8 bits are combined to a byte, or several bytes to a word.

Block

Several measurements are combined into a block. A closed block is indicated by a $\bar{\text{I}}$ on the LCD display. A block can be closed only by pressing the **BLOCK-RES** or **FINAL-RES** key followed by **ENTER** (or a measurement).

Block result

After pressing the **BLOCK-RES** key, the measurements will be combined into a block and the results of the evaluation of the current block (e.g., mean value and standard deviation of the measurements combined into this block) will be displayed or printed.

Block size

Number of single readings that are combined to form a block.

Block mean value

Mean value of the measurements combined into a block.  Fe.

Block result  **Block result****Carriage Return (CR)**

Carriage return. CR is a character of the ASCII character set with the following function: When data or commands are entered, the line one is currently working on will be closed by pressing the CR key (Enter or Return key); the information entered will be processed accordingly. The cursor is again placed at the beginning of the line. It is usually used together with the LF (Line Feed) character to start the next line at the beginning.

Chi squared test (χ^2 -Test)

This test is performed during the final evaluation with the FERITSCOPE® FMP30 to determine whether the evaluated measurements have a normal distribution (for more than 40 readings).  Normal distribution (Gaussian normal distribution, Gaussian distribution).

Cp  *Process capability index*

Cpk  *Process capability index*

CR (Carriage Return)  *Carriage Return (CR)*

DIP switch

Dual Inline Package = electronic component ready to be installed. In this case, a series of little switches. They are often used in peripheral devices, i. e., in printers, to change the basic settings of the device.

Three-point calibration  *Corrective calibration (one-point or two-point calibration)*

EEPROM (Electrically Erasable Programmable Read Only Memory)

Electrically erasable and programmable read only memory. The memory contents can be erased electrically.

Control Limits

If the measurements are documented in a process control chart, the control limits define the area where the measured variable may be located without the need for process control measures.

One-point calibration  *Corrective calibration (one-point or two-point calibration)*

Calibration standards  *Calibration standards (ferrite standards)*

Single reading

Measurement result that is displayed or printed after a single measurement at the measurement location.

Final result

Evaluation of all readings that are stored in the open Application. The results of this evaluation (e.g. mean value and standard deviation) will be displayed or printed after **FINAL-RES**.

External Start

With external start enabled, the measurement acquisition can be triggered by pressing the ^ key or by sending the G0 (G Zero) from a connected PC.

Excess  *Curvature*

Fe.

Mean value. The arithmetic mean value $Fe.$ is the sum of Fe_i readings of a measurement series (a Blocks), divided by the number N of readings.

$$Fe. = \frac{(Fe_1 + Fe_2 + \dots + Fe_N)}{N} = \frac{\sum_{i=1}^N Fe_i}{N}$$

where: $Fe.$ = Mean value (block mean value)

Fe_i = single reading

N = single readings (of a block)

Fe..

Mean value of the block mean values of the evaluated blocks. Standard deviation of the readings that have been taken using a fixed block size. Is output only if fixed block size  Block

$$Fe.. = \frac{1}{N_{Bl}} \cdot \sum_{j=1}^N Fe.j$$

where: $Fe..$ = Mean value of the block mean values

N_{Bl} = Number of evaluated blocks

$Fe.j$ = Block mean values

Ferrite standard  *Calibration standards (ferrite standards)*

Final Result  *Final result*

“Free-running” display



With the probe placed on the specimen, measurements are displayed continuously. Indicated by a  on the LCD display of the FERITSCOPE® FMP30.

Gaussian normal distribution  *Normal distribution (Gaussian normal distribution, Gaussian distribution)*

Gaussian probability paper  *Probability chart (Gaussian probability paper, sum frequency chart, probability paper)*

Gaussian distribution  *Normal distribution (Gaussian normal distribution, Gaussian distribution)*

Accuracy

Qualitative designation for the degree of approximation of a measurement result to the true value. Usually, the accuracy is divided into  Trueness (Accuracy of the mean) and  Precision.

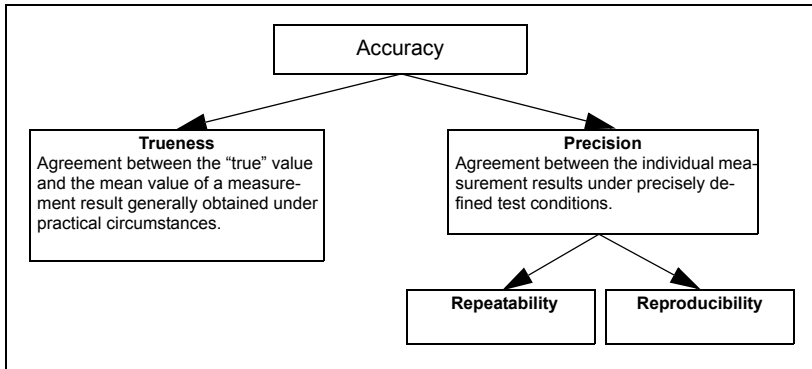



Figure 16.1: Accuracy terms (Detailed information in / 20 /)

Tolerance limits (Specification limits)  *Specification limits (LSL and USL)*

Maximum value

Maximum value measured in a test series.

Grubbs Test

Method for outlier rejection.  Outlier rejection

Group Separator

mark for the end of a block that can be transferred together with the measurement data to the PC.

Frequency distribution  *Histogram*

Histogram (frequency distribution)

Graphic representation of the single readings of a measurement series by classes (ferrite content ranges) of equal width. The degree to which a statistical result is meaningful depends, among other things, on this distribution. When evaluating the current application with a FERITSCOPE® FMP30, the histogram of the ferrite content measurement values will be printed as follows:

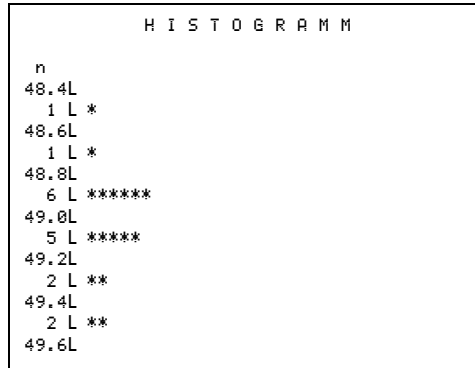

Figure 16.2: Printout of a histogram (example)

Calibration curve (characteristics)

Quantitative relationship between the probe signal and a function of the ferrite content as defined by calibration standards.

The mid portion of the calibration curve approaches a straight line and constitutes the range with the lowest relative measurement error.

As long as no normalization or corrective calibration has been performed, the calibration curve is identical with the master calibration curve. During normalization or corrective calibration the calibration curve is adjusted to the individual measurement application and the coefficients of the normalization or corrective calibration are stored in the open Application.

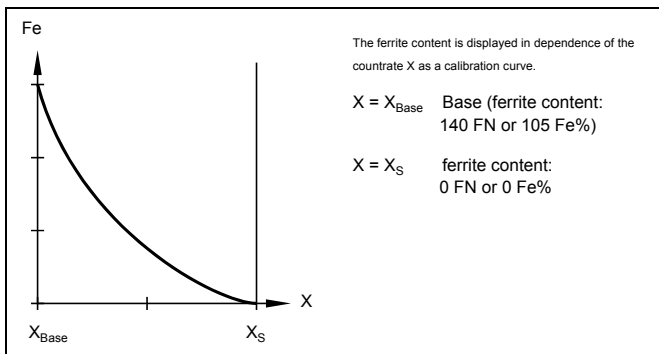

Figure 16.3: Calibration curve
(ferrite content as a function of the countrate)

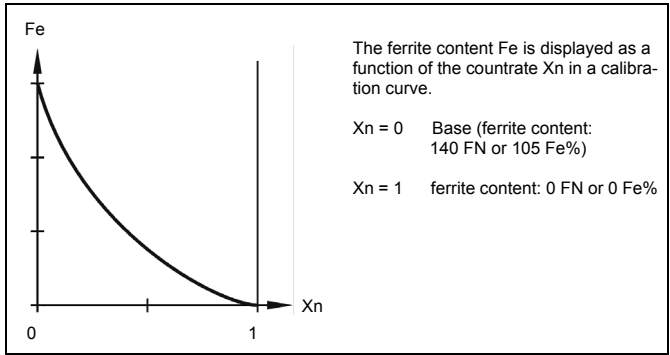



Figure 16.3: Calibration curve (ferrite content as a function of the normalized countrate)

Calibration standards (ferrite standards)

Objects with the same attributes (or as close as possible) as the measuring object with known ferrite contents that have been measured with an extremely accurate test method.  Calibration standard set

Calibration standard set

The calibration standard sets used for the corrective calibration of the FERITSCOPE® FMP30 consist of the Base and three calibration standards of different ferrite contents (cf. Figure 16.5). Various calibration standards sets for corrective calibration are available from Fischer to prepare the instrument for different measuring ranges.

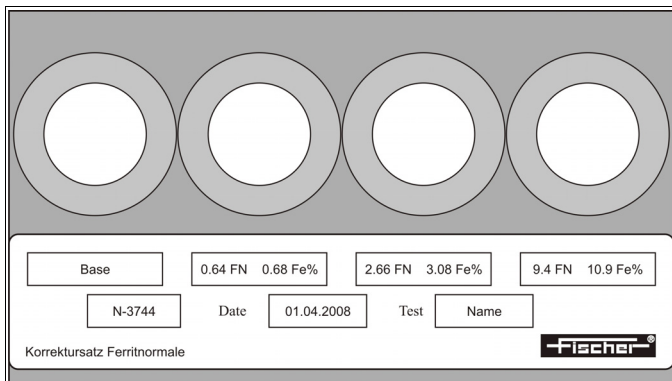

Figure 16.5: Calibration standard set (example)

Calibration Standards  *Calibration standards (ferrite standards)*

Characteristic  *Calibration curve (characteristics)*

Class

Range between a lower and an upper class boundary (e.g., ferrite content limits). The single readings of a measurement series can be sorted according to classes of equal width, which cover the entire range of the measurement series. The number of measurements per class plotted for each class is called a histogram.

Minimum Value

Minimum value measured in a measurement series.

Kolmogoroff Smirnoff Test

Test, which is performed when evaluating the current application with the FERITSCOPE® FMP30 to determine whether the evaluated measurements can be classified as having normal distribution (if up to 40 measurements are to be evaluated).

System Check

A significant part of monitoring the test equipment. Calibration standards or, even better, reference samples, are used to check the calibration and to verify the stability of the instrument.

Control limits  *Control Limits*

Control chart  *Process control chart (quality control chart, SPC chart)*

Corrective calibration (one-point or two-point calibration)

Adjustment of the instrument using a Base and one or two calibration standards. The corrective calibration includes calibration and adjustment. During the corrective calibration, the calibration curve is adjusted to the individual measuring application that the open application is calibrated for. The coefficients of the adapted calibration curve are stored in the open Application. The coefficients of the master characteristic stored in the EEPROM of the probe plug are not affected.

Kurtosis  *Curvature*

LCD display (Liquid Crystal Display)

Liquid crystal display. The LCD display of the FERITSCOPE® FMP30 is large and clear and includes numerous symbols for identifying the instrument status and as well as information for operator guidance.

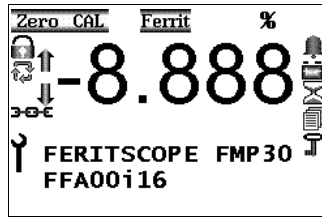

Figure 16.6: LCD display of the FERITSCOPE® FMP30

Line feed (LF)

LF line feed. Advances the printer paper by one line. Is usually used together with the CR (carriage return) character to start the next line at the beginning.

Unit of measurement

Unit for displaying measurement data. In ferrite content measurement, the common units of measurement are ferrite numbers (FN) or ferrite percent (Fe%).

Master calibration

Adjustment of the instrument using calibration standards. During a master calibration, the master calibration curve is determined. The master calibration includes calibration and adjustment.

Master characteristic (Probe characteristic)

Characteristic of the measurement system, (Calibration curve (characteristics)). The master calibration curve is determined during master calibration on the Base and calibration standards and is the basis for determination of the measurement values, since it represents the relationship between the ferrite content and the probe signal. The coefficients of the master calibration curve are stored in the EEPROM of the probe plug.

Maximum

Highest reading of a measurement series.

Features

Properties of a product. Variable features are the measurable properties of a product subject to change or variability; e.g., ferrite content is a variable feature. Attributive features are the properties of a product that usually cannot be captured by taking measurements. Examples are, deviations in color, or whether the product is true to gauge size.

Measuring

Measuring is comparing. The probe signal generated at the measuring position is compared to the probe signal of the calibration standard. Using the calibration curve, the instrument converts the probe signal to the measurement result.

Measuring Application

Structure of the measuring object according to material, thickness and other properties (hard/soft, porous/dense, homogenous/inhomogeneous, etc.) and any other conditions relevant to the measurement requirement. These factors determine the selection of a suitable test method, the probe type and the instrument.

Measurement Range

The range between the two limits within which a measurement is possible at a specified trueness and precision. In a narrower sense, it refers to the range of the scale of an analog instrument. The measurement range depends on the test method, the design of the probe, and the measurement application.

Measurement errors

The difference between the actual and the measured value of a measured variable. For measuring instruments, there is a distinction between random (unpredictable) and systematic (correctable) measurement errors. Random errors determine the repeatability precision. Systematic errors affect the trueness and the reproducibility. Systematic errors are far more prevalent in practical ferrite content measurement applications (see / 12 / for further details). Systematic errors can be traced to

1. faulty calibration,
 2. operation-related or operator-related errors, or
 3. changes in test conditions (inhomogeneities of the substrate, aging, etc.).
- Systematic errors tend to lean in one direction. With appropriate care, causes 1 and 2 can usually be avoided or corrected. Causes of the third kind can be corrected by system checks or can be taken into account in the result.

Specimen  *Measuring Object*

Measurement accuracy  *Accuracy*

Monitoring of test equipment

A quality assurance task. It consists of ensuring that the measuring system (instrument) is operating properly and is still calibrated correctly, and to take

corrective measures, if necessary (re-calibration of instrument or repair).

 System Check

Measuring Object

Object on which the measurements are to be performed to determine the ferrite content for example.

Measurement Series

A series of single readings between two block or final results.

Measurement probe  *Probe*

Measurement Location

A limited and clearly defined point within the reference area of the specimen where the ferrite content is to be determined. (For detailed information, see / 13 /.)

Uncertainty of measurement  *u*

Measurement method

Procedures and process to obtain information about the properties of a measuring object. The test method is based on scientific findings and depends on the application. (For further details, see / 16 /.)

Measurement

Numeric reading of an instrument, expressed in the unit of measurement. The measurement can be obtained as the result of a single measurement or as arithmetic mean of several single measurements (e.g., when auto averaging mode is enabled).

Measurement block  *Block*

Minimum

Lowest measured value of a test series.

Mean value  *Fe*.

Re-initialization

The restoration of the default settings of the instrument. With a re-initialization of the instrument, all Applications are deleted, i.e., the stored measurement data as well as the normalization and the corrective calibration of all Applications. After a re-initialization, all Applications must be set up anew! In addition all settings in the service functions are reset to the default settings (i.e., to the factory settings). If necessary, the settings will have to be made again. However, time, date and language are not reset by the re-initialization.

The coefficients of the master characteristic that is stored in the EEPROM of the probe plug are not affected by a re-initialization because the re-initialization concerns only the memory of the instrument.

Standard  *Calibration standards (ferrite standards)*

Normal distribution (Gaussian normal distribution, Gaussian distribution)

Probability distribution discovered by C. F. Gauß in 1794. If a quantity X can be classified as having normal distribution, 68.3 % of the observed values of X are within the σ interval around the mean value μ of the variable X , i.e., the following applies to 68.3% of the observed values: $\mu - \sigma \leq X \leq \mu + \sigma$.

This interval is indicated in Figure 16.7 by the gray area below the curve.

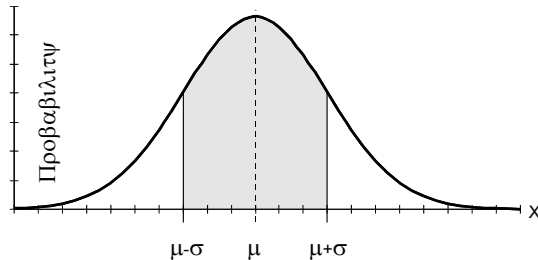



Figure 16.7: Probability distribution $P(X)$ of a quantity X , which can be classified as having normal distribution

The probability distribution $P(X)$ is symmetrical around the mean value μ of the quantity X , which can be classified as having normal distribution. Skewness and Curvature are zero for the normal distribution.

The populations, which are tested for technical purposes, often can be classified as having approximately normal distribution. However, the following fact is of great importance: if several random samples with equal size are drawn of a population, and the mean values of these random samples are determined, these mean values can be classified as having normal distribution (Central Limits Theorem). The mean value of these sample mean values is an estimated value ($\hat{\mu} = Fe.$) for the mean value μ of the population. The uncertainty of measurement u can be determined using the standard deviation of the sample mean values (since the sample mean values can be classified as having normal distribution).  u

Whether a quantity can be classified as having normal distribution can be checked in the normal probability chart, since a straight line in the normal probability chart indicates normal distribution. When evaluating the current

application with the FERITSCOPE® FMP30, a Kolmogorov-Smirnov test is performed for small random samples (up to 40 measurements) and a χ^2 test is performed for large random samples (more than 40 measurements) to check whether the measurements can be classified as having normal distribution.

Normalized countrate  *Countrate*

Normalization

Adjusting a measuring instrument to a new zero value (countrate X0). Important for some applications when the base material changes, or when the test method is subject to instability (e.g., to drift) (e.g. for beta backscatter and X-ray fluorescence methods). During normalization, the calibration curve is adjusted to the individual measurement application that the open Application is calibrated for. The coefficients of the adjusted calibration curve are stored in the open Application. The coefficients of the master calibration curve, which are stored in the EEPROM of the probe plug, are not affected.

Offline

State of a peripheral device (printer or PC) connected to the instrument that does not allow it to receive data.

USL

Upper specification limit.  Specification limits (LSL and USL)

Online

State of a peripheral device (printer or PC) connected to the instrument that allows it to receive data; the connected instrument is ready for operation.

Local ferrite content

The local ferrite content is the arithmetic mean value of the single measurements performed on the reference area.



Parity

An error checking method where the digits of a number of error-free transmitted bit groups must add up to an even or an odd number. During data transfer the parity bits are added to the data bits of each character or Byte to be transferred. In every word, this bit is set such that Ones of the byte always result in an even or an odd number (corresponding to an even or odd parity). The type of parity must be defined prior to the data transfer. By checking the parity, the receiver can determine if simple bit transfer errors occurred.

Pin

Connectors for integrated circuits or connecting plugs of technical devices. Usually in the shape of a pin.

Precision

Agreement between the single measurement results under precisely defined test conditions. The precision is composed of reproducibility and repeatability.  Accuracy;  Reproducibility;  Repeatability/Repeatability precision

Process capability

The process capability is assessed by the indices cp and cpk. (For further information see / 4 /.)

Process capability is met when the process capability exceeds specified values. Commonly required is:

$$c_p > 1,33 \quad \text{and} \quad c_{pk} > 1,0$$

Process capability is a measure for long-term influences stemming from the so-called 6 Ms (mankind, machine, material, method, measuring instrument and milieu). To determine the process capability, a longer sequence of cyclical production steps needs to be employed (same product, same production line, same conditions, but different orders on different days).

Process capability index

The process capability is assessed by the indices cp and cpk. (For further information see / 4 /.) The process capability index cp takes the deviation of a process in relation to the width of the specification limit range (USL-LSL) into account. The process capability index cpk takes the position of the mean value in relation to the set specification limits into account. The FERITSCOPE® FMP30 computes Cp and Cpk as follows:

$$c_p = \frac{OGW - UGW}{6 \cdot \hat{\sigma}}$$

$$c_{pk} = \text{Min} \left[\left(\frac{OGW - Fe..}{3 \cdot \hat{\sigma}} \right); \left(\frac{Fe.. - UGW}{3 \cdot \hat{\sigma}} \right) \right]$$

where: *Fe..*: Mean value of the group mean values

Cp: process capability index

Cpk: critical process capability index

USL: upper specification limit

LSL: lower specification limit

$\hat{\sigma}$: estimated value for the theoretical standard deviation  σ

Process control chart (quality control chart, SPC chart)

Statistical Process Control (SPC) often uses random samples to control a production such that the production process is under statistical control. To do this, the variable features of the manufactured product are entered in a process control chart. Process control charts plot process variation over time and help to identify the causes of variations. A random sample is taken from the production process, is measured and the result (e.g., mean value and standard deviation (x-s chart)) is graphically documented. The results of the control chart are used to determine when action should be taken in the process.

Quality control chart  *Process control chart (quality control chart, SPC chart)*

Quality assurance

All measures taken by a producer to ensure a controlled production process within the established quality criteria. One aspect of it is quality control, specifically, ferrite content measurements where ferrite content limit specifications are involved.

R

Range R of all measurements being displayed in the process control chart. The range is the difference between the maximum measurement Fe_{max} and the minimum measurement Fe_{min} in a measurement series.

$$R = Fe_{max} - Fe_{min}$$

R.

Mean range across all block ranges.

$$R. = \hat{\sigma} \cdot d_2$$

where: R. = mean range

$\hat{\sigma}$ = :Estimated value of the standard deviation s of the population

d_2 = Factor, depends on the random sample size, can be obtained from popular published tables.

Reference area

A portion of the significant surface area of a product where one or more measurements are to be taken. It is recommended to include the reference area or significant surface area in the production specifications, in addition to the specifications limits for the ferrite content.

Reference sample  *Reference sample*

Control chart  *Process control chart (quality control chart, SPC chart)*

True value  *Trueness (Accuracy of the mean)*

Trueness (Accuracy of the mean)

Agreement between the true value and the mean value of a measurement result generally obtained under practical conditions. ( Accuracy; for detailed information, see / 20 /.) The true value is a value known from mathematical theoretical formulations. Since such values are seldom encountered, a value deduced from national or international standards is taken as “right”. This right value is often called the true value.

s

The standard deviation s is a measure of the deviations of single measurements of a measurement series from their common mean value. It is equal to the mean square deviation of the single measurements from the mean value and is calculated as follows:

$$s = \sqrt{\frac{(Fe. - Fe_1)^2 + (Fe. - Fe_2)^2 + \dots + (Fe. - Fe_N)^2}{(N - 1)}}$$

where: s = standard deviation

$Fe.$ = mean value of all single readings

Fe_i = single readings

N = number of readings

Figure 16.8 demonstrates that two measurement series with different standard deviations can still have the same mean value.

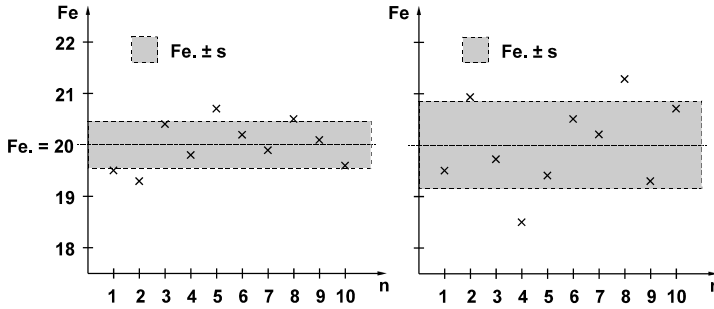

Figure 16.8: Measurement series with the same mean value but different standard deviation

s.

Standard deviation of the readings that have been taken using a fixed block size.

$$s. = \frac{1}{N_{Bl}} \cdot \sum_{j=1}^{N_{Bl}} s_j$$

where: *s.* = mean standard deviation of the block standard deviations

N_{Bl} = number of evaluated blocks

s_j = standard deviation of the readings of a block

sa

Calculated by the FERITSCOPE® FMP30 only when the measurements were performed with fixed block size and the deviations of the block mean values cannot be attributed to the deviations within the subgroups, as determined by analysis of variance methods (A.O.V.). It describes the deviations of the block mean values in relation to the deviations of the single measurements within the blocks. With a suitable measurement strategy, *sa* is a measure of the product deviation

$$sa = \sqrt{\frac{s_{II}^2 - \hat{\sigma}^2}{N_j}}$$

where: *sa* = deviation of the block mean values corrected with regard to the deviation of the single readings

s_{II}  s_{II}

N_j = block size (number of readings per block)

$\hat{\sigma}$ = estimated value for the standard deviation σ of the population

If, for instance, the same number of measurements is performed on several specimens and the readings on each object are combined into a block (e.g., when making measurements with a fixed block size), s_i is a measure for the instrument deviation and s_{II} is the product deviation with the instrument deviation eliminated.

sII

Deviation of the block mean value around the overall mean value s_{II} is calculated as follows:

$$s_{II} = \sqrt{N_i} \cdot \sqrt{\frac{1}{N_{Bl} - 1} \cdot \sum_{j=1}^{N_{Bl}} (Fe_{..} - Fe_{.j})^2}$$

where: s_{II} = deviation of the block mean values

N_{Bl} = Number of evaluated blocks

N_i = block size (number of readings per block)

$Fe_{..}$ = mean value of the block mean values

$Fe_{.j}$ = block mean values

$\hat{\sigma}$

Estimated value for the standard deviation σ of the population.

$$\hat{\sigma} = \frac{s_i}{c_4}$$

where: $\hat{\sigma}$ = estimated value for the standard deviation σ of the population

s_i = mean standard deviation

c_4 = The factor c_4 depends on the random sample size and can be obtained from popular published tables, e.g., / 4 /.

Skewness

Measure for the asymmetry of a single-peak probability distribution around its mean value. A positive skewness indicates a distribution whose peak stretches more towards values that are greater than the mean value. A negative skewness indicates a distribution whose peak stretches more towards values that are smaller than the mean value. The skewness of symmetric distributions is zero (e.g., for normal distributions). When evaluating the open Application with the FERITSCOPE® FMP30, the skewness is calculated according to the information in / 20 /.

Interface

Transfer or connecting point between components, circuits or programs. Interfaces are used for data transfer. Using a serial interface, the data are transferred bit by bit. Using a parallel interface, the data are transferred by sending several bits simultaneously.

Sigma outlier rejection

 Outlier rejection Method for the outlier rejection.

Probe

The instrument receives the electrical probe signal, which is proportional to the ferrite content measured, from the probe. The probe signal is then converted by means of the calibration curve into the ferrite content reading. The Fischer E... probes are equipped with a memory chip (EEPROM) in the probe plug. The EEPROM stores probe-specific information (e.g., probe type, manufacturing code, test method and coefficients of the master calibration curve).

Probe characteristic  *Master characteristic (Probe characteristic)*

Range  *R*

SPC

Statistical Process Control.  Statistical Process Control (SPC)

SPC chart  *Process control chart (quality control chart, SPC chart)*

Memory

Data storage element of a microprocessor-based measuring instrument.

Information is saved in the memory.  Application

Specifications

Requirements according to which production is defined within certain limits for variable and attributive properties, like for instance the lower and the upper specification limit for the ferrite content. Quality control monitors adherence to these requirements.

Specification limits  *Specification limits (LSL and USL)*

Stability

As with every process, test methods are also subject to deviations. This may lead to systematic measurement errors (e.g., drift), independent of handling. By examining the stability and by regular checks, one can ensure stability.

Standard deviation  s**Statistical Process Control (SPC)**

A quality control method. In high volume productions, only random samples are taken instead of 100% inspection which would be too costly. The measurement results of the random samples are extrapolated for the entire production lot with mathematical-statistical methods, and then used to control the production process. This modern method of quality control ensures constant good manufacturing quality, **with a minimum level** of rejected parts. Normal distribution of the measurements is required so that statistical process control can be used for quality control purposes.

AC adapter

The FERITSCOPE® FMP30 can be connected to a power outlet via the AC adapter.

Random sample

A representative group selected from the production lot, using random sample principles. The sample is used to determine the properties of the entire lot (batch, unit of production).

Random sample size

Number of parts, combined into a random sample.

Stop bit

With serial asynchronous data transfer, the stop bit is added to the data word to be transferred. 1 to 2 bit logic Ones are used. After the stop bit, the sender remains at logic One until the start bit of the next character arrives.

Student factor  t**Sum frequency**

A form of display of the measurement data distribution, such that the number of measurements smaller or equal to a particular measurement is calculated and displayed in percent.

Sum frequency chart  *Probability chart (Gaussian probability paper, sum frequency chart, probability paper)*

Systematic measurement errors  *Measurement errors*



t

The student distribution factor t can be obtained from any popular publication of mathematical statistics tables (e.g., / 4 /) and is given as follows:

$$t \left(1 - \frac{\alpha}{2} \right); f$$

Example: At a confidence level of 95 % and $N > 200$ (resulting in a degree of freedom $f = 199$ (because of $f = N - 1$)), the student factor is $t_{97.5;199} = 1.96$.

Specification limits (LSL and USL)

The lower specification limit LSL is the minimum ferrite content allowed for the measuring object. The upper specification limit USL is the maximum ferrite content allowed for the measuring object. Specification limits are usually set by engineering requirements to assure proper functioning or serviceability of the product ( Specifications) With specification limits monitoring enabled,  on the LCD display of the FERITSCOPE® FMP30.

u

Uncertainty of measurement. The mean value $Fe.$ of a random sample is not equal to the mean value μ of the population. However, using the measurement uncertainty, it is possible to define an interval, in which the mean value μ of the population will be found with a certain probability (indicated as confidence level):

$$Fe. - u < \mu < Fe. + u$$

For a population having normal distribution, the uncertainty of measurement u is calculated as follows for a given confidence level $(1 - \alpha)$:

$$u = \frac{t \cdot s}{\sqrt{N}}$$

where: u = measurement uncertainty

t = student factor

s = standard deviation

N = number of readings

By entering the coefficient of variation C.O.V. in place of the standard deviation s one gets the relative measurement uncertainty u_{rel} in %. (For further details, see / 12 /.)

$$u_{rel} = \frac{t \cdot V}{\sqrt{N}}$$

Data transfer rate  *Baud Rate*

LSL

Lower specification limit.  Specification limits (LSL and USL)

C.O.V.

Coefficient of variation. The standard deviation of a measurement series in percentage points, i.e., the standard deviation in reference to the mean value. For many manufacturing processes, C.O.V. [%] is a characteristic process constant. A change in a parameter during the coating process can alter C.O.V. [%] significantly; thus, a sudden change of C.O.V. [%] indicates a change in the process conditions. C.O.V. [%] is calculated as follows:

$$V = \frac{s}{Fe.} \cdot 100[\%]$$

where: *COV* = coefficient of variation

Fe. = mean value

s = standard deviation

Variable features  *Features*

Variance

Mean squared deviation. The square root of the variance is called standard deviation.

Coefficient of Variation  *C.O.V.*

Method  *Measurement method*

Reproducibility  *Reproducibility*

Reference measurement

Measurement on a reference sample to check the normalization or calibration which was performed before.

Reproducibility

The ability of different operators to achieve practically the same measurement result, when taking measurements with different instruments at the same measuring position of the same specimen at different locations.

( Accuracy; for detailed information, see / 20 /.)

Reference sample

Specimen with a known ferrite content on a defined reference area that can be used to check the calibration. The ferrite content within the reference area should be as regular as possible. The reference sample should have the same properties (geometry, etc.) as the specimen on which the calibration was performed. The reference samples may be from in-house production or may be from external sources. The ferrite content of a reference sample should have been determined using a reliable and properly calibrated instrument. Reference samples are used for the monitoring of test equipment.

With contacting measurements, reference samples are subject to wear and tear in the same manner as the calibration standards. The wear and tear is dependent on the properties of the surface and on the probe which used for measurement. For this reason, reference samples have to be checked regularly and replaced by new reference samples if the wear and tear becomes significant.

Confidence level  u

True value  *Trueness (Accuracy of the mean)*

Probability chart (Gaussian probability paper, sum frequency chart, probability paper)

Can be used to check graphically for normal distribution of the measurements. A straight line in the normal probability chart indicates normal distribution.

Probability paper  *Probability chart (Gaussian probability paper, sum frequency chart, probability paper)*

Significant surface

Area on the surface of a specimen containing the ferrite content to be measured. All properties necessary for the use and appearance of the product must occur at this significant area.

Repeatability/Repeatability precision

The standard deviation of the measurements taken under repeatability conditions is a measure for the repeatability. The smaller the standard deviation of these measurements, the better is repeatability. The repeatability is dependent on the test method and the quality of the instrument, but often also on the properties of the specimen (e.g., surface roughness). The standard deviation of the measurements under repeatability conditions can be reduced by generating the mean value of the measurements (such as in auto-averaging mode).

( Accuracy; for detailed information, see / 20 /.)

Curvature

Excess and Kurtosis are measures for the curvature (e.g., how pointed or how wide) of a distribution compared to a normal distribution. A positive curvature indicates a relatively narrow, pointed distribution. A negative curvature indicates a relatively flat distribution. The curvature of a normal distribution is Zero. When evaluating the open Application with the FERITSCOPE® FMP30, Excess is calculated according to the information in / 20 / and stated as curvature.

X

Countrate  Countrate

X_{Base}

Zero point of the calibration curve. Countrate obtained when measurements are taken on the Base of the calibration standard set.  Countrate

X_n

Normalized countrate.  Countrate

X_s

Countrate obtained when measuring on a measuring object with no ferrite content.  Countrate

Countrate

Digitized form of the measurement signal, which is proportional to the ferrite content and is produced in the probe by the ferrite content. The larger the ferrite content is, the smaller is the countrate.  Calibration curve (characteristics)

The numeric values of the normalized countrate X_n range between 0 and 1, and are calculated according to the following equation:

$$X_n = \frac{X - X_{Base}}{X_s - X_{Base}}$$

where: X_n = normalized countrate

X = count rate measured on the specimen

X_{Base} = countrate measured on the Base of the calibration standard set

X_s = countrate measured on a specimen with no ferrite content

Random measurement error  *Measurement errors*

Two-point calibration  *Corrective calibration (one-point or two-point calibration)*

12.2 Additional Literature

12.2.1 Statistics and ferrite content measurement

/ 1 /	American Welding Society 1974: Standard procedures for calibrating magnetic instruments to measure the delta ferrite content of austenitic stainless steel weld metal (ANSI/AWS A4.2-97); Miami, Florida
/ 2 /	DataMyte Corporation: DataMyte Handbook - A practical guide to computerized data collection for Statistical Process Control
/ 3 /	Duncan, Acheson J.: Quality Control and Industrial Statistics; Homewood Illinois: Richard D. Irwin, Inc.
/ 4 /	Ford Q-101: Quality System Standard
/ 5 /	Graf, Henning, Stange, Wilrich: Formeln und Tabellen der angewandten mathematischen Statistik; Berlin, Heidelberg, New York: Springer-Verlag
/ 6 /	Helmut Fischer GmbH Institute for Electronics and Metrology: Report reprints
/ 7 /	Kotecki, D. J.: Extension of the WRC Ferrite Number System; Welding Research Supplement November 1982, S. 352-s ... 361-s
/ 8 /	Müller, P. Heinz: Wahrscheinlichkeitsrechnung und Mathematisches Statistiklexikon der Stochastik; Berlin: Akademie-Verlag
/ 9 /	Rönz, Bernd und Strohe, Gerhard (Herausgeber): Lexikon Statistik; Wiesbaden:- Gabler-Verlag
/ 10 /	Sachs, Lothar: Angewandte Statistik - Anwendung statistischer Methoden; Berlin, Heidelberg, New York: Springer-Verlag
/ 11 /	Sachs, Lothar: Statistische Methoden; Berlin, Heidelberg, New York: Springer-Verlag

12.2.2 Standards

/ 12 /	DIN 1319, Parts 1, 2 and 3: Basic Concepts in Metrology
/ 13 /	DIN EN ISO 2064: Definitions and Conventions Concerning the Measurement of Coating Thicknesses (previously DIN 50 982, Part 1)
/ 14 /	DIN EN ISO 2178: Measurement of Coating Thicknesses: Magnetic Methods (previously DIN 50 981)
/ 15 /	ISO 3534: Statistics; Vocabulary and Symbols
/ 16 /	DIN EN ISO 3882: Review of Methods for Coating Thickness Measurements (previously DIN 50 982, Part 2)
/ 17 /	DIN ISO 5725: Precision of Test Methods; Determination of Repeatability and Reproducibility Through Round Robin Tests
/ 18 /	DIN 50 982, Part 3: Principles of Coating Thickness Measurement: General Fundamentals - Selection Criteria and Basic Measurement Procedures
/ 19 /	DIN 55 302 Parts 1 and 2: Statistical Evaluation Methods
/ 20 /	DIN 55 350: Terminology in Quality Assurance and Statistics
/ 21 /	DIN-Taschenbuch 175 - Prüfnormen für metallische und anorganische nichtmetallische Überzüge - Normen; Berlin, Köln: Beuth Verlag GmbH
/ 22 /	DIN-Taschenbuch 223 - Qualitätssicherung und angewandte Statistik - Begriffe; Berlin, Köln: Beuth Verlag GmbH
/ 23 /	DIN-Taschenbuch 224 - Qualitätssicherung und angewandte Statistik - Verfahren 1; Berlin, Köln: Beuth Verlag GmbH
/ 24 /	IIW Document II-1269-95 (II-C-034-95) - Draft Revision of ISO 8249-1985 (E) and II-C-023-94: Welding - Determination of Ferrite Number in austenitic and duplex ferritic-austenitic Cr-Ni stainless steel weld metal
/ 25 /	DIN EN ISO 8249: Welding - Determination of Ferrite Number (FN) in austenitic and duplex ferritic-austenitic Cr-Ni stainless steel weld metals
/ 26 /	DIN 32 514, Part 1: Determination of the ferrite number in austenitic weld metal
/ 27 /	Basel-Standard (BN2)

Index

A

- AC adapter, connector socket 15
- Accessories 23
- Acoustic signals 92, 93, 178
- Air humidity 26
- Ambient Temperature 11
- Analog display 173
- Application 45
 - Assign designation 52
 - delete 49
 - Linking 63
 - List 50
 - New 45
 - Save 67
 - select 48
 - set up 45
 - Settings 52
- Area measurement 90, 182
- Assign application designation 52
- Auto-Averaging Mode 58
- Automatic Block Creation 57
- Automatic measurement 182
- Automatic measurement acquisition 90, 92

B

- Base 13
- Battery
 - Battery compartment 15
 - Battery compartment cover 31
 - Battery replacement 31
 - Symbol 17
- Bidirectional data exchange
 - Control commands 142
- Block change 174
 - automatic 176
 - manual 176
- Block Creation
 - automatic 57

Block mean values 161, 162, 163

Block size 94

C

- Calibration
 - Deleting corrective calibration 75
 - Master calibration 77
- Calibration Standard
 - Certification 25
- Calibration Standards 13, 24
- Cleaning 41
- Content of Shipment 27
- Contrast 153
- Control commands 142
- Corrective calibration 71, 72
 - Print form 76
- Corrective calibration, deleting 75

D

- Data transfer
 - virt. COM-Port 140
- Date 150, 151
- Description
 - Technical Terms 205
- Display
 - Free-running 17
- Driver installation 139

E

- EEPROM 23
- EMC 11
- Enabled specification limits 94
- Environmental Conditions 11
- Error messages 194
- Evaluation
 - Print 146
- External start 180

F

- Fe% 184
- Fixed block size 94
- FN 184
- Formulas 205
- Free-running display 17
- Free-running mode 161, 162, 163

G

- Glossary 205
- Group separator 141, 161, 162, 163

H

- Histogram and block evaluation 159

I

- i individual value 58, 96
- Instrument
 - Content of Shipment 27
 - Dimensions 26
 - On/Off 36
 - Options 28
 - Power consumption 26
 - Repairs 14
 - Voltage supply 30
 - Warranty 14
 - Weight 26
- Instrument configuration 188
 - Print form 188
- Instrument mode 171
- Instrument setting 147
 - Measured variable 185
 - Printer 146
 - Service functions 147
- Instrument settings
 - Analog display 173
 - Area measurement 182
 - Automatic measurement 182
 - Block change 174

- Contrast 153
- Date/Time 150, 151
- External start 180
- Histogram and block evaluation 159
- Instrument mode 171
- Language 149
- Lighting 154
- Limited operating mode 171
- Master calibration 187
- Measurement acquisition signal 178
- Measurement effect 179
- Measurement output 161, 162, 163
- Re-initialization 157
- Standard and matrix measuring mode 174
- Storage mode 187
- Switch off mode 156

Intended Use 10

K

- Keys 15
 - APPL NO 21
 - Arrow down 21
 - Arrow up 21
 - BLOCK-RES 20
 - CAL 20
 - DEL 19
 - ENTER 22
 - FINAL-RES 19
 - MENU 22, 52
 - ON/OFF 15, 20, 37
 - PRINT 22
 - ZERO 20

L

- Language 149
- LCD Display 15, 16
- LCD display
 - Contrast 153
 - Lighting 154
- Lift-off distance 26

Lighting 154
Limited Operating Mode 16
Limited operating mode 171
Linking mode
 Applications 63
 enable/disable 64
Low Voltage 11

M

Making measurements
 acoustic signals 93
Malfunctions 190, 194
Master Calibration 187
Master calibration 77, 79
 Print form 84
 Xn Ranges for calibration standards 83
 Xn ranges for the calibration standards 85
Measured variable 185
Measured variables 40
Measurement
 enabled outlier rejection 97
 Enabled specification limits 94
 Fixed block size 94
 Influencing parameters 87
 Making 87
 Preparation 86
 Single reading mode 96
Measurement Acquisition 89
 Area measurement 90
Measurement acquisition
 acoustic signals 92
 Automatic 90, 92
Measurement display 56
Measurement effect 179
Measurement method 36
Measurement output 161, 162, 163
Measuring modes 26
Messages 194

N

New 45
Normalization 68, 69
 Print form 70
Normalized count rate Xn 85

O

Offline operation 141
On/Off 36
Online operation 140
Operating Personnel 10
Options 28
Outlier measurement 97
Outlier rejection 60, 97

P

Peep tone 92, 93, 178
Power Connection 11, 30
Power consumption 26
Printer 25
 connection 146
 Printer output 146
 Settings 164
Printer output 146
Probe 23
 Angle probe 88
 axial 88
 Connection 33
 Connector Socket 15
 Handling 12, 42
probe
 assigning 43
Probe connector 33
Probe connector socket 34
Probe plug 23, 34

R

Readings
 Group separator 141
 Transfer to PC 140

Rechargeable battery 31
Re-initialization 157
Repairs 14
Resolution of the measurement display 56

S

Service function
 Analog display 173
 Area measurement 182
 Automatic measurement 182
 Block change 174
 Contrast 153
 Date/Time 150, 151
 External start 180
 Histogram and block evaluation 159
 Instrument mode 171
 Language 149
 Lighting 154
 Master calibration 187
 Measured variable 185
 Measurement effect 179
 Measurement output 161, 162, 163
 Printer 146
 Re-initialization 157
 Standard and matrix measuring mode 174
 Storage mode 187
 Switch off mode 156
Service functions 147
Single reading mode 96
Single readings 161, 162, 163
Specification Limits 54
Specification limits 94
Standard and matrix-measuring mode 174
Storage mode 187
Switch off 41
Switch off mode 156

Switch on 37

T

Technical Data 26
Technical Terms 205
Temperature
 Operation 26
 Storage 26
Terms 205
Time 150, 151
Transfer formats 141

U

Unit 184
USB
 Connection 139
 Connector 15, 138
 Driver 139
 Port 139
USB connection 138

V

Voltage supply 26, 30

W

Warning messages 194
Warranty 14
Weight 26

X

Xn 85

