

INSTRUCTION MANUAL

Industrex

M43ic / M43icN NDT FILM PROCESSOR



AT800 v2.8r09p and up



7952 Nieman Road, Lenexa, KS 66214-1560 USA
Phone: 913-685-0675, Fax: 913-685-1125
www.ndtsupply.com, sales@ndtsupply.com

Industrex M43ic / M43icN

NDT - Filmprocessor

Technical Specifications

Processing applications: Rolls/Cut sheets of all commonly used industrial x-ray films

Film thickness: 0,10 mm (4mil) - 0,18mm (7mil)
 Material width: min. 7,5 cm max. 43cm
 Material length: min. 10 cm

Capacities for:	Time in Developer [sec]	Cycle Time (dry to dry) [min]	Intake speed [cm/min]
Industrex M43ic (6MW)	31	2,1	128
	184	12,6	22

additional, see the table on the next page

Tank capacity

Developer:	13,5L
Fixer:	13,3L
Wash water:	11,6L
Cooling liquid	2,5L

Solution heating (FIX and DEV): adjustable in a range of 18,0°C - 43,0°C
 (separate inline 350W heaters)

Cooling system (FIX and DEV): Integrated cooling system with chiller assy and cooling pump

Dryer: warm air
 adjustable in a range of 18°C - 60°C

Replenishment: fully automatic
 replenishment is microprocessor controlled and calculated from information received from sensors measuring the width and length of material entering the processor.
 Replenishment cycles are adjustable.

Wash water distribution: built in 1-way magnetic valve
 Wash water flow rate: 2,0 ltr/min when film is processed
 Wash water supply pressure: 3 - 10 bar
 Wash water supply: filtered at a temperature of 8°C - 15°C
 with 3/4" hose connection
 Wash water drain: 32mm Ø (5/4inch) hose or tube

Weight:

Empty	177 kg
With solution	215 kg

Technical specification subject to change without notice.

Input speed / DEV-time / Cycle-time:

Industrex M43ic / M43icN

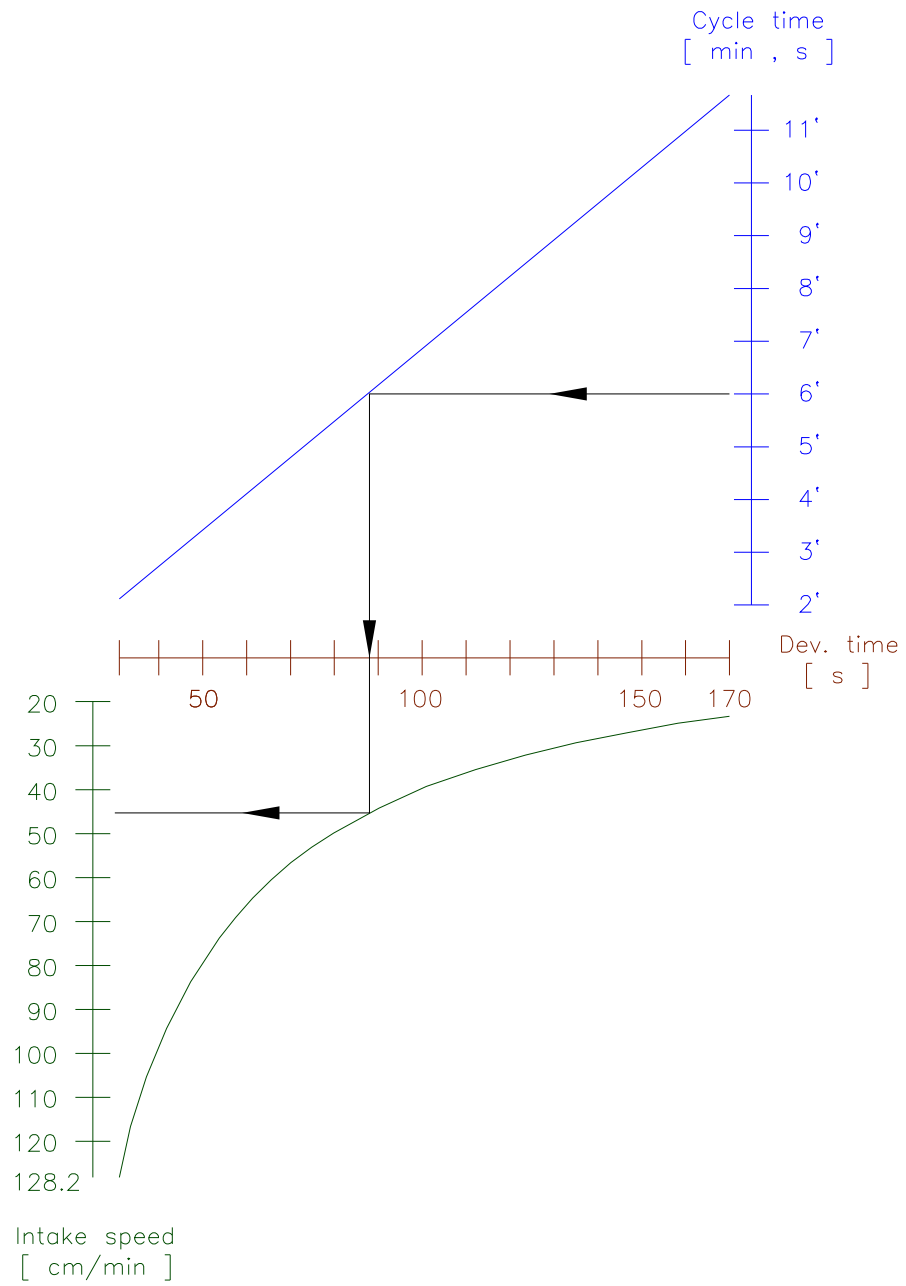

Dimensions of Industrex M43ic/M43icN NDT-Filmprocessor: cm(inch)



We recommend a minimum walking space of 50 cm around the processor.

Technical specification subject to change without notice.

Electrical supply:

single phase
230 V AC

**Industrex
M43ic / M43icN**

**3,6 kW
16 A**

ATTENTION:
PROCESSOR TO BE CONNECTED TO
SUPPLY NET: 220V 50/60Hz

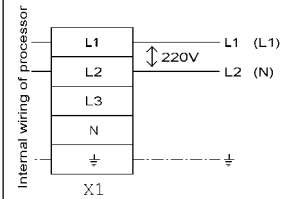

In case the above voltages are
not available at site, please
contact your local dealer or
the factory for rewiring advice.

Details for shipment:

packing dimensions: 1 wooden box on palette
120cm x 100cm x 175cm (L x W x H)
packing volume: 2,1 m³
weight with packing: 320 kg

INDEX

1. INTRODUCTION	7
1.1 GENERAL SAFETY INSTRUCTIONS	2
1.1.1 Explanation of the warning signs used in this instruction manual	2
1.1.2 Qualified staff and system operation	4
1.1.3 Mechanical hazards	5
1.1.4 Electrical hazards	5
1.1.5 Fire hazards	6
1.1.6 Chemical hazards:	7
1.1.7 WEEE/RoHS Compliance Statement	9
2. CHEMISTRY DRAINS / WATER DRAINS	10
2.1. INSERT OF THE TRANSPORT RACKS	11
3. THE FIRST STEPS	14
3.1 USING THE CHEMISTRIES	14
4. WORKING WITH THE FILMPROCESSOR	15
4.1 PROCESSOR FUNCTIONS	16
5. THE DISPLAY	17
5.1 PROGRAMMING PROCEDURES	18
5.2 CHANGING THE PROGRAM	21
5.3 AUTOMATIC MODE	22
5.4 STANDBY OPTIONS	23
5.5 MANUAL REPLENISHMENT CYCLE	24
5.6 ERRORS CODES	25
5.7 MANUAL START/STOP	26
5.8 DISPLAY ILLUMINATION ON/OFF	26
5.9 AUTOMATIC START	26
5.10 DISTANCE BETWEEN FILMS	27
5.11 MONITOR MODE:	27
5.12 FILTER CONTROL:	29
5.13 ADDITIONAL FEATURES - REFILL WATER / CHEMISTRY	30
6. TEMPERING SYSTEM	32
7. TEMPERATURE SENSING	32
8. I2C-BUS SYSTEM	33
9. VENTILATION	33
10. CHEMICAL REPLENISHMENT SYSTEM	34
10.1 INFRARED REPLENISHMENT SENSORBAR	35
11. MAINTENANCE	36
12. RECOMMENDED MAINTENANCE EVERY 3-6 MONTHS	37
13. TROUBLE SHOOTING	38

1. INTRODUCTION

Congratulations upon your decision to buy a

Industrex M43ic / M43icN NDT PROCESSOR.

Your purchase has been designed to meet the highest technical standards.

Some outstanding design features are:

- *) compact, space-saving design
- *) full automatic processing cycle
- *) smooth roller transport system
- *) low tank volumes
- *) electronically controlled temperature system
- *) automatic replenishment
- *) low energy consumption

This manual is an instruction for routine use of your:

Industrex M43ic / M43icN NDT PROCESSOR



NOTE: This equipment has been tested and found to comply with the limits for a Class A digital device, pursuant to part 15 of the FCC rules. These limits are designed to provide reasonable protection against harmful interference when the equipment is operated in a commercial environment. This equipment generates, uses and can radiate radio frequency energy and, if not installed and used in accordance with the instruction manual, may cause harmful interference to radio communications. Operation of this equipment in a residential area is likely to cause harmful interference in which case the user will be required to correct the interference at his own expense.

1.1 GENERAL SAFETY INSTRUCTIONS

1.1.1 Explanation of the warning signs used in this instruction manual



Danger: Used to indicate a directly hazardous situation with instructions that must be obeyed to avoid risk of serious or fatal injury.

Warning: Used to indicate a potentially hazardous situation with instructions that must be obeyed to avoid risk of serious or fatal injury.

Caution: Used to indicate a potentially hazardous situation with instructions that must be obeyed to avoid risk of minor or moderate injury.



Note: Signal word that indicates a potentially harmful situation which, if not avoided, may result in damage to the device.

Hazard symbols used in this manual:



Drawing in hazard:

To warn against contact with moving parts that can entrap clothing and body parts causing serious injury.



Crushing hazard:

Possible contact with moving parts leading to crush injuries.



Electrical hazard:

Electrical hazard - possible contact with main voltage.



Thermal hazard:

Thermal hazard - possible contact with parts having high temperature.



Fire hazard:

Fire hazard - possibility of flammable material igniting.



Chemical hazard:

Chemical hazard - chance of chemical burns if chemicals are not handled correctly.

Hazard sticker used on the processor:



Isolate the electrical power-supply before opening.
Used on covers where applicable.

Symbols giving orders used in this manual:



Protective clothing:

To always wear protective clothing when working with chemicals, moving parts or electricity.



Working gloves:

To always wear appropriate gloves when working with chemicals, moving parts or electricity.



Safety goggles:

Wear safety goggles when working with chemicals.



Fire extinguisher:

Where there is a potential fire hazard always make sure, that a fire extinguisher is readily available.

Prohibitive signs used in this manual:



No necklaces:

Wearing loose necklaces when working with moving parts can lead to entrapment.



No ties:

Wearing loose necklaces when working with moving parts can lead to trapping or drawing in.

1.1.2 Qualified staff and system operation

CAUTION:

Only trained staff to be allowed to unpack or operate the device. Only trained service engineers are allowed to work on the equipment and electrical installation.



Staff in charge of maintaining the processor (see chapter 11 and 12) need to be thoroughly familiar and trained with the equipment. The equipment should not be operated without supervision.

Only the top cover of the film processor may be removed by the operator (see picture below)

Top cover

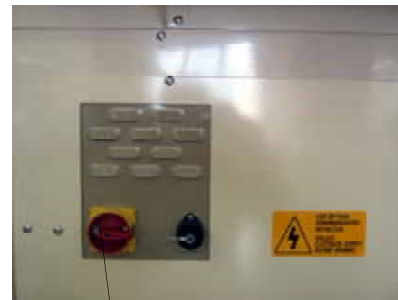

Main switch of the film processor

CAUTION:

The installation, service, repair as well as the initial operation of the machine must be carried out by qualified and trained service personnel only !



Carry out the following steps prior to removing the top cover:

1. Give instructions to the operators of the film processor.
2. Switch off the main power switch („0“-position)

The film processor is a complex machine with moving parts such as rotating gears and roller components. It uses photo processing chemicals which are irritating to eyes, lungs and skin. High voltage is used to power the film processor.

DANGER:

Do not operate the film processor after consuming alcohol or taking strong medication.



Industrex M43ic / M43icN

Room temperatures between 18-26 °C (65-80 °F) with a relative humidity between 35% and 75% are ideal for photographic processing and working.

WARNING: Electrical and mechanical hazards
Observe all safety warnings to minimize the risk of electrical shock, burns or equipment damage.
Photographic film processors are complex machines with many electrical and mechanical parts as well as with a considerable amount of chemicals.



1.1.3 Mechanical hazards

Observe all safety warnings to minimize the risks of mechanical hazards.

WARNING:
Hands or fingers may be pinched or injured by moving parts or when handling heavy parts.



Make sure that clothing or other objects cannot get trapped in gear drives or the roller transport system within the film processor.

Do not wear jewellery or loose clothing when operating the processor.



WARNING:
The roller transport system of the processor is a potential hazard - fingers, loose clothing or jewellery can get drawn into rollers or gearwheels.



1.1.4 Electrical hazards

DANGER:
During installation qualified service personnel must certify that the processor is permanently and reliably grounded according to the standards in the national electrical code.



Industrex M43ic / M43icN

The film processor must be separated from mains power prior to carrying out any maintenance. This is done by switching the mains power switch of the machine to the „0“ position. Built-in safety devices must not be by-passed or made inoperative. Only use original COLENTA spare parts when replacing failed electrical components.

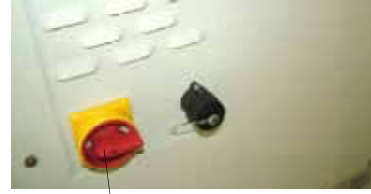

Main power switch

DANGER:
Hazardous voltage can cause electrical shocks, burns or fatal injury !



1.1.5 Fire hazards

Fire Prevention

Beware that combustible materials ignite and cause fires.

WARNING:
The area around 3 meters of the processor must be kept clean at all times. Keep dust, wood shavings, scrap paper or other inflammable materials out of the dryer compartment.



A functional 5kg ABC fire extinguisher must be available in the room where the processor is installed.



Burn hazard

CAUTION:
Dryer compartment produces heat. Dryer parts and covers get hot, therefore do not touch dryer parts or covers when the processor is in operation.



Fire hazards

WARNING:
Dryer compartment produces heat - Paper or other flammable material can ignite.



1.1.6 Chemical hazards:

Corrosive liquids

WARNING:
CHEMICALS MAY IRRITATE EYES, LUNGS, SKIN AND DIGESTIVE TRACT



Eyes, skin and lungs may be irritated by photo chemicals. Before using photo processing chemicals always read the Material Safety Data Sheets (**MSDSs**) for information about the hazards of the particular chemicals and how to use them safely contact the chemicals manufacturer or dealer.

Wear safety goggles, protective gloves and chemical aprons as indicated on Material Safety Data Sheets (**MSDSs**) when handling chemicals.



CAUTION:
To avoid hazardous situations, keep floors and floor coverings around the processor and associated drains clean and dry at all times. Any accumulation of fluids outside the film processor should be cleaned/removed immediately.
Ensure proper ventilation in the area where chemicals are prepared, used or stored.



Drain tanks carefully, avoid splashing. Always drain the system thoroughly before working on any of the external hose systems. Do not allow untrained personnel to handle photo processing chemicals or to operate the film processor.

Chemical disposal

Waste from photographic processing normally contains diluted chemicals. These chemicals should be collected and disposed in accordance with local environmental codes. Dumping chemicals into a drain system could lead to a pollution problem. Contact your local water treatment and sewer district authorities before disposing chemicals. All plumbing must comply with local and national codes. The DRAIN must be made of chemical resistant and non-corroding material. Use PVC or equivalent.

Exhaust, temperature and humidity

It is necessary to ensure proper ventilation in order to receive good processing results. Make sure that the exhaust hose of the built-in exhaust fan is properly connected to the exhaust air socket (Picture 1). The built-in exhaust fan exhausts the fumes from the film processor. These chemical fumes are corrosive. The top cover and the feed cover lid of the film processor should be left slightly open over night (picture2).

Industrex M43ic / M43icN

Picture 1

exhaust ventilation system



Picture 2

Top cover



WARNING:

Take care when draining the processor tanks for cleaning with running water. ALL racks must be removed from the processor for cleaning.



CAUTION

Chemical handling and accident prevention

Misuse of almost any chemical may create a hazard of some type. Generally photo chemicals are not any more dangerous than most of the regular cleaning agents. However, there is always a residual risk. When handling chemicals observe the procedures below.

- 1). Never smell into a container or open bottle to determine its contents. A cautious sniff of the cap or lid is safer.
- 2). Label storage containers properly. Avoid storing hazardous chemicals on high shelves or in unprotected glass containers. Keep chemicals away from children. Do not store chemicals in a refrigerator used for food because they may contaminate food or be mistaken for edibles.
- 3). Observe the manufacturer's recommendations for using and mixing chemicals.

CAUTION:

Overexposure to photographic chemicals may cause skin irritation to certain individuals.



CAUTION

**PHOTOGRAPHIC CHEMICAL EMERGENCIES
AND FIRST AID PROCEDURES:**

- **SKIN** - Rinse thoroughly with water.
- **EYES** - Rinse thoroughly with water and consult a physician.
- **BY MOUTH** - Consult a physician immediately.



1.1.7 WEEE/RoHS Compliance Statement

EU Directives WEEE and RoHS

To our valued customers:

We are committed to being a good corporate citizen. As part of that commitment, we strive to maintain environmentally conscious manufacturing operation.

The European Union (EU) has enacted two directives, the first on product recycling (**W**aste **E**lectrical and **E**lectronic **E**quipment, **WEEE**) and the second limit the use of certain substances (**R**estriction on the use of **H**azardous **S**ubstances, **RoHS**). Over time, these directives will be implemented in the national laws of each EU member state.

Once the final national regulations have been put into place, recycling will be offered for our products which are within the scope of the WEEE Directive. Products falling under the scope of the WEEE Directive available for sale after August 13, 2005 will be identified with a “wheelie bin” symbol.

Two categories of products covered by the WEEE Directive are currently exempt from the RoHS Directive – category 8, medical devices (with the exception of implanted or infected products) and category 9, monitoring and control instruments. Most of our products fall into either category 8 or 9 and are currently exempt from the RoHS Directive. We will continue to monitor the application of the RoHS Directive to its products and will comply with any changes as soon as they apply.

Batteries incorporated into our products are exempted from the readily removed requirement of the directive for data integrity reasons, and are not marked with the separate collection and chemical symbols because end users are not expected to dispose of the battery separately from the product. Such batteries shall be separated from the product during the treatment phase of the product as required under the WEEE Directive. In particular, this exemption applies to the button or “coin” cell lithium batteries that are supplied embedded in some of our equipment.

Battery: CR2032
Weight Battery: 2.8 Grams
Description: Lithium Coin, 3V, 20mm
Quantity per Unit: 1 Piece

In the European Union, this symbol indicates that when the last user wishes to discard this product, it must be sent to the appropriate facility for recovery and recycling.

Contact your local representative for additional information on the collection and recovery programs available for this product.



- **Do not dispose product with municipal waste**
- **Special collection/disposal required**



Reference:

Original text of the amended EU Battery Directive:

http://eur-lex.europa.eu/LexUriServ/site/en/oj/2006/1_266/1_26620060926en00010014.pdf

EPBA web site:

<http://www.epbaeurope.net>

2. CHEMISTRY DRAINS / WATER DRAINS

To drain the filmprocessor (Developer, Fixer and the Wash) just open the drain taps according the illustrations below. Take care that all the mentioned drain taps are close during re-fill up.

IMPORTANT: Used Developer and used Fixer has to be collected in suitable containers seperately.

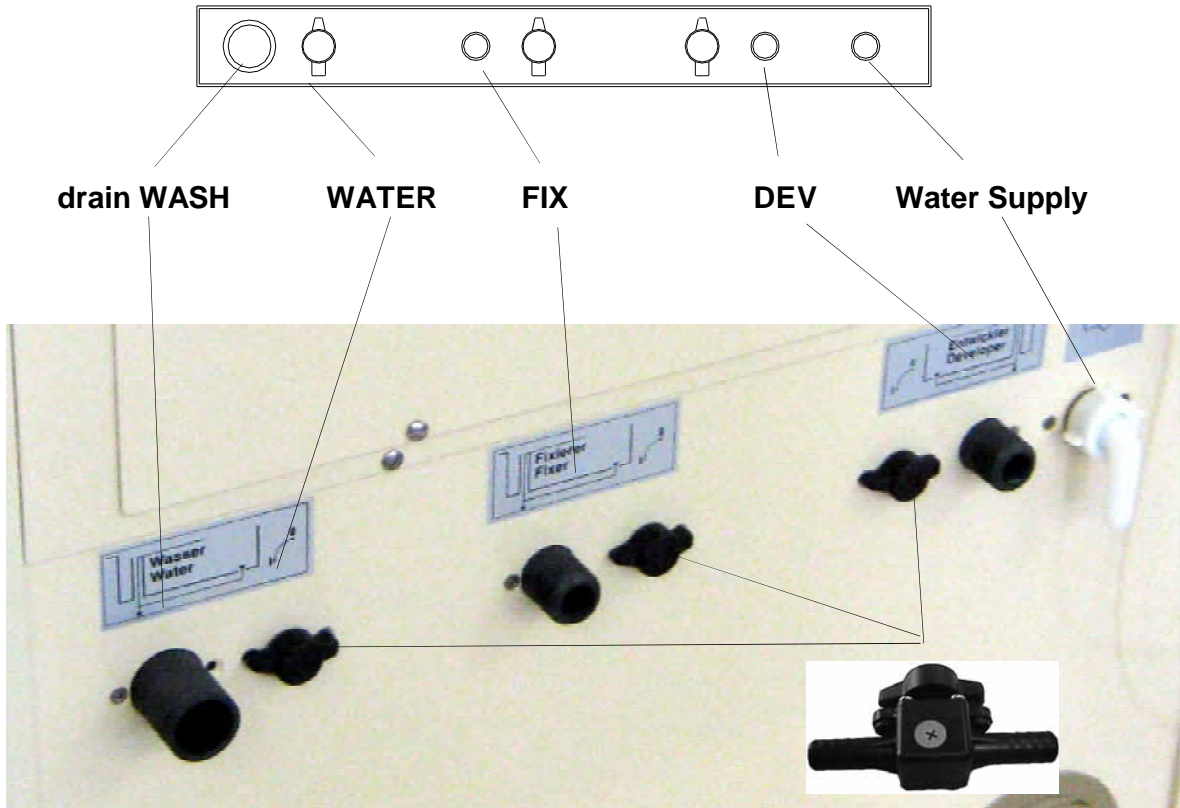

Drain taps:

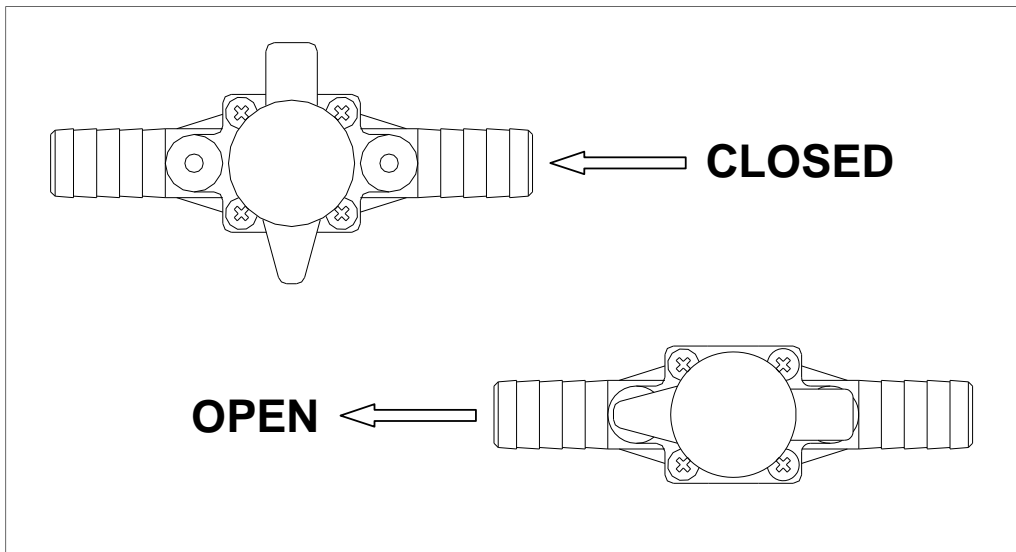

2.1. INSERT OF THE TRANSPORT RACKS

WARNING: Separate the Film Processor from mains. To do so, switch the main power switch of the Filmprocessor to „0“ position. Wear safety goggles, protection gloves and clothing.

- *) Rinse the tanks with water and then fill it to the red marker on the tank wall.
- *) Remove all packing materials
- *) Rinse the tanks with water and then fill it to the red marker on the tank wall.

RACK 1 in the developer tank
RACK 2 in the fixer tank
RACK 3 in the water tank
Dryer in the dryer

CAUTION:

Take care that all gears are installed as shown.

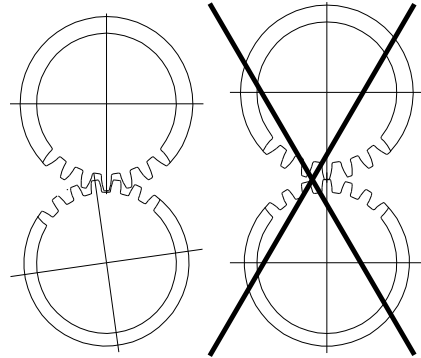

The supporter of the racks to be completely set into the grooves of the tank.

Version with Spraybar

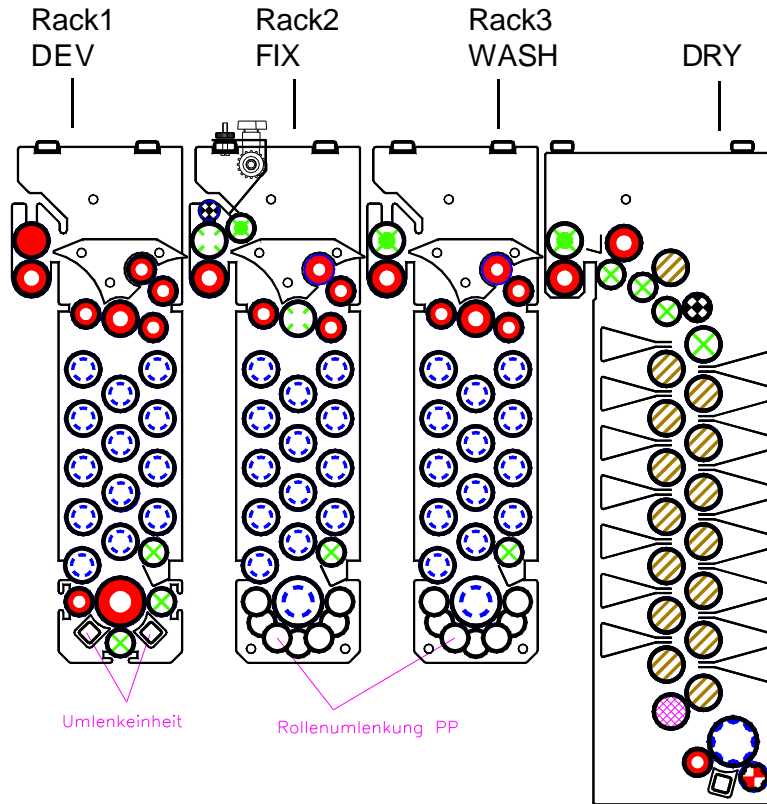

- PVC poliert
- PVC poliert schwer
- PVC geschliffen
- PE poliert
- PE poliert schwer
- PE spezial
- Gummi schwer
- Gummi leicht
- Gummi segmentiert
- Schaumstoff
- Phenol
- Stahl

Version without Spraybar (Dry cross over)

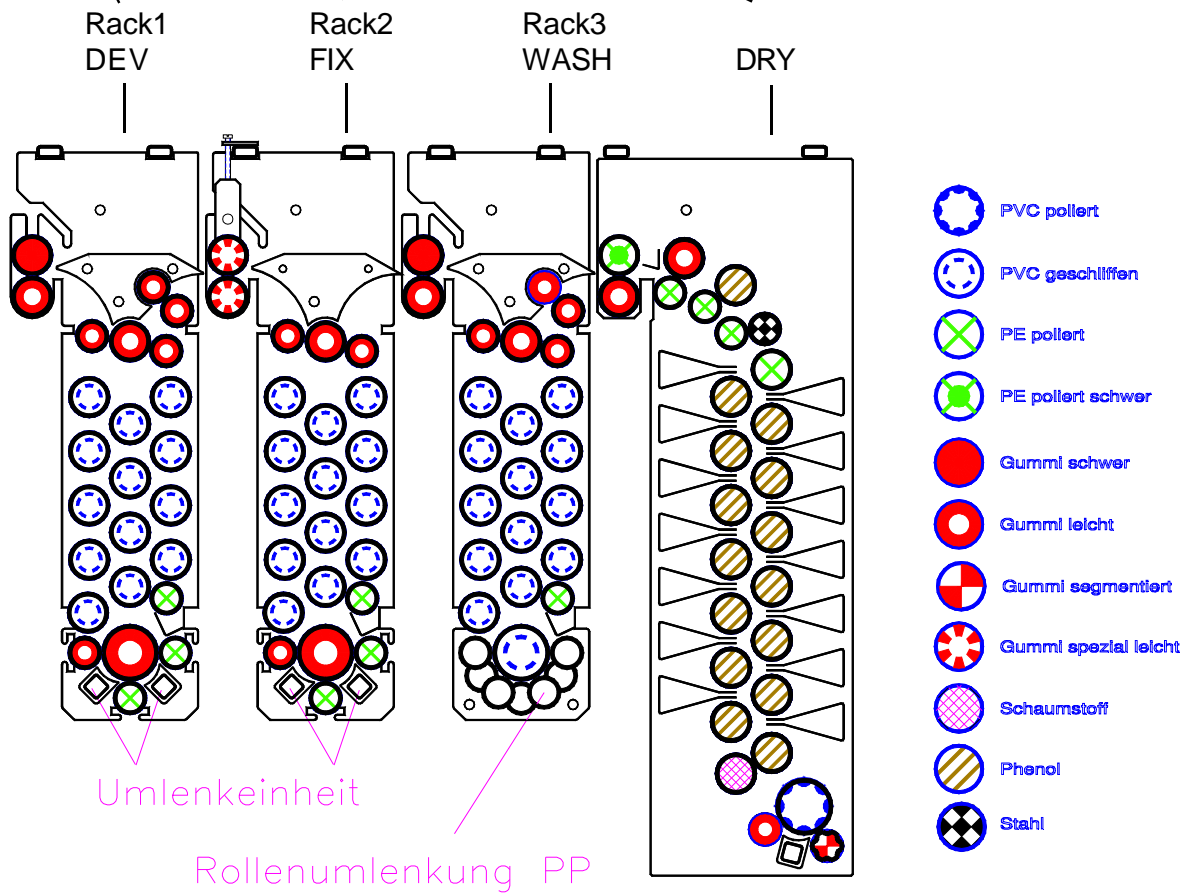
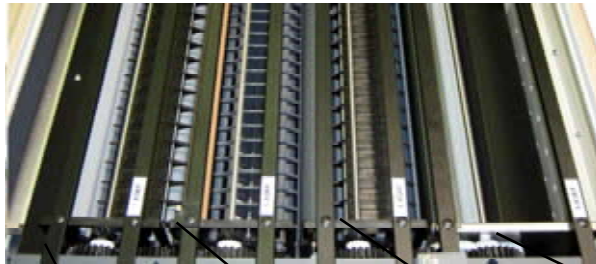

ADDITIONAL CONNECTION FOR THE FIX RACK

Following up the page before,
open/close the hose connector by pressing the marked button:

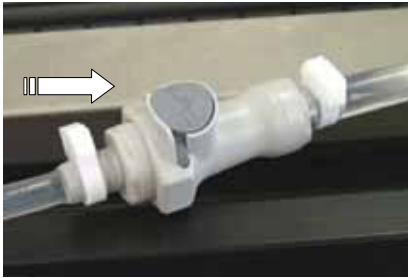

FIX RACK

CAUTION:
Pay special attention to
the Roller configuration
about the FIX Rack!

- 1 Steel roller Ø 19mm
- 2 PE roller Ø 26mm
- 3 Special PE roller Ø 32mm

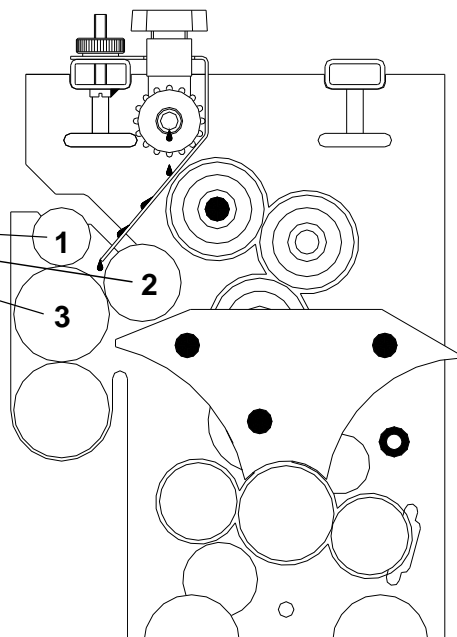

Separate package for rollers



3. THE FIRST STEPS

WARNING: Separate the Film Processor from mains. To do so, switch the main power switch of the Filmprocessor to „0“ position. Wear safety goggles, protection gloves and clothing.

3.1 USING THE CHEMISTRIES

- *) Only use chemistry suitable for roller transport systems.
- *) Follow instructions of chemistry manufacturers.

FIXER BATH:

- *) Empty fixer tank by opening the fix drain tap.
- *) Remove the **Fixer**-rack.
- *) Check fixer tank is free of alien material.
- *) Close fix drain tap.
- *) Fill fixer tank with ready-to-use-fixer solution to the red marker on the tank wall. Insert the **Fixer**-rack very carefully and slowly, add hardener solution if advised by the chemistry manufacturer.

DEVELOPER BATH:

- *) Empty developer tank by opening dev drain tap.
- *) Remove the **Developer**-rack.
- *) Check developer tank is free of alien material.
- *) Close dev drain tap.
- *) Fill developer tank with ready-to-use-developer solution to the red marker on the tank wall. Insert the **developer**-rack very carefully and slowly. Replenishment tanks may be used to mix the chemistry. Any remaining can be used for replenishment.

<p>CAUTION: Even the smallest quantity of fixer could contaminate the developer solution. Therefore, always fill with fixer first. When removing the fixer rack, always cover the developer tank. For removing the fixer rack use rack carrier tray (optional accessory)</p>

4. WORKING WITH THE FILMPROCESSOR

IN THE MORNING

- *) Turn on water supply.
- *) Check replenishment tank levels.
- *) Check whether that the water drain tap is closed
- *) Switch on the Filmprocessor with the Filmprocessor main switch (position „1“).
- *) Wait for the "READY" of the processor

STARTING WORK

- *) Check level of the replenishment containers (DEV&FIX)
- *) Check level of the waste containers (DEV&FIX)
- *) Select programme
- *) Feed through min. two green cleaning films - full size.
- *) During feeding films, always check the free-signal, given form the display.
- *) Ensure first rollers pull material.
- *) Feed large format films in straight.
- *) Put a leader on roll films
- *) Fold the leading edge on roll paper.

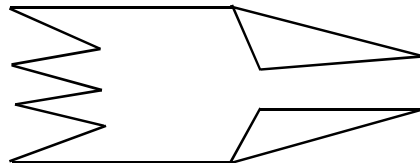

IN THE EVENING

- *) Turn off water supply.
- *) Switch off the main power switch of the Filmprocessor. (Main switch in position „0“)
- *) Open water drain tap to prevent algae growths in water tank.

- *) **Lift the top cover to prevent condensation !!**



4.1 PROCESSOR FUNCTIONS

PROGRAMMING:	Automatic processing parameters, e.g., temperature, speed and replenishment rates, can be stored in 9 different programmes.
WARMING-UP:	Once programmed, temperature settings are accurately controlled. Heating commences with switching on at the mains. Constant solution temperatures are maintained in the processing tanks. Temperatures tolerances +/- 0,2 °C are achieved by the microprocessor control unit while the solutions are circulated by circulation pumps. When temperature has reached PRE-SET levels, the filmprocessor enters STANDBY mode and is ready for use.
STANDBY:	In case no material is processed - after a programmable periode of time, since the last media has exited the filmprocessor transport, dryer and water supply is switched off automatically. The filmprocessor goes in standby mode and is ready for work.
ANTICRYSTALLI-ZATION CYCLE	During STANDBY mode - within a programmable cycle periode - transport and intermediate rinse bath water supply is activated - this prevent cristallization build up on crossover rollers.
ANTI-OXIDATION CYCLE	During STANDBY mode - and no material is processed during set time - an preprogrammable ANTI OXIDATION cycle (replenishment cycle) is available. The additional replenishment compensates the impact of airoxidation of the chemistry during standby mode und tops up the chemistry levels in the tanks, compensating evaporation of the water in the solutions during standby.
AUTO REPLENISHMENT:	The filmprocessor comes equipped with a film area measuring facility. Infrared sensors scan the film area touchless and when the preprogrammed amount of film (area) entered the filmprocessor, a replenish-cycle is activated.
AUTOMATIC START-STOP:	Infrared sensors also automatically control the startcycle of the filmprocessor. The filmprocessor changes from STANDBY to RUN once a film has interrupted the light barrier. As the rollers turn, water is supplied to the wash tank and to the intermediate rinse bath system. Once the last film has passed through, the filmprocessor reverts to STANDBY. The film can be taken out of the receiving basket or top cover lid.

5. THE DISPLAY

Number of programs	9
Temperature range, developer and fixer	18,0 ÷ 43,0°C
Temperature range, dryer	18 ÷ 60°C
Temperature control tolerances	±0.2°C
Temperature measurement resolution	0.03°C
Developing time tolerances at max. speed	±2%
· Motor speed is quartz-stabilized and controlled by a separate microprocessor	

The display

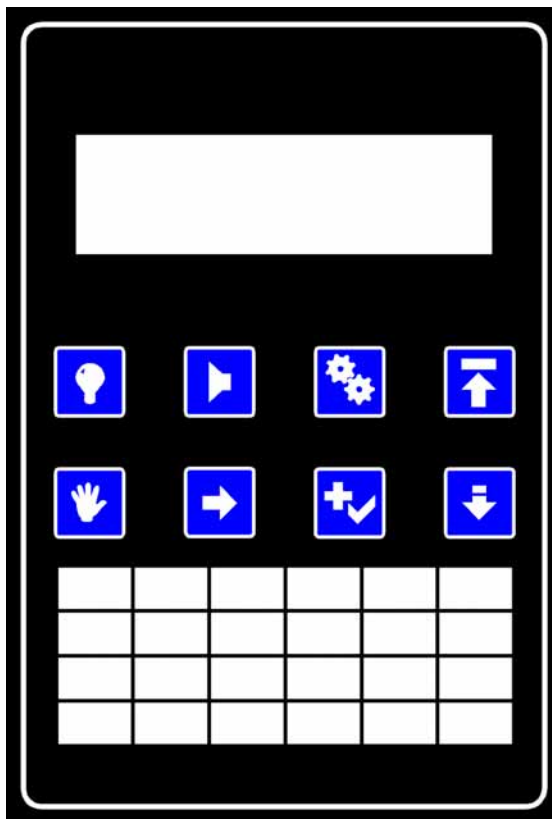

- 1 back light ON/OFF
- 2 check errors /alarm shutdown
- 3 setup mode
- 4 back to top menu
- 5 manual operation
- 6 move cursor
- 7 select menu item/change value
- 8 scroll page down

5.1 PROGRAMMING PROCEDURES

Switch on the Filmprocessor with the Filmprocessor main switch (position „1“).
By default it starts in work mode. Make sure that no media is being processed, since re-programming is enabled only during standby.

Press **3**. The programming menu will appear:

**NOTE for RS232: only
in use when a COLENTA
Auto loader is in use.**

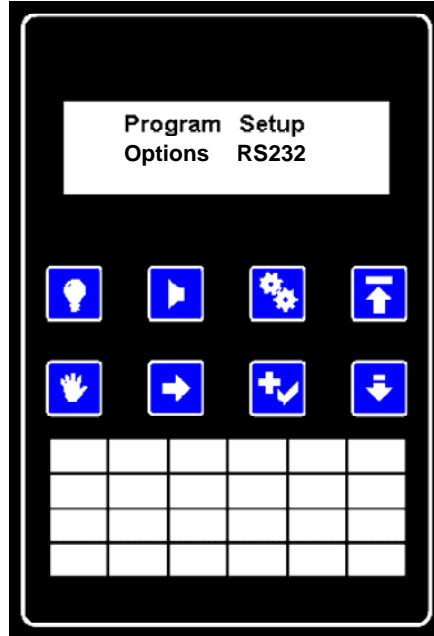

With **6**, move the cursor under Program and select it with **7**.
You will see

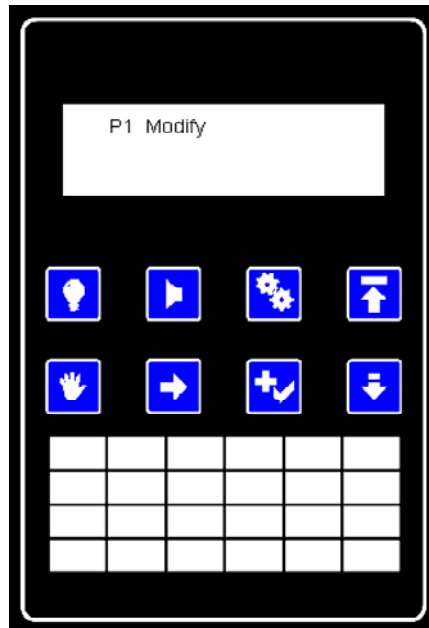

Industrex M43ic / M43icN

Press **7** to change the number of the program you wish to modify.

With **6**, move the cursor under Modify and select it with **7**.

The programme consists of four pages:

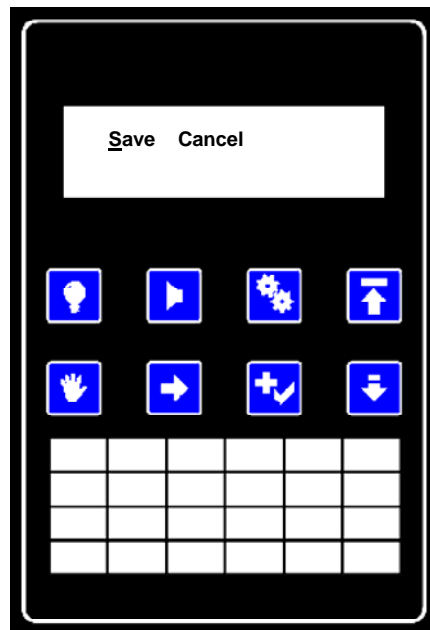
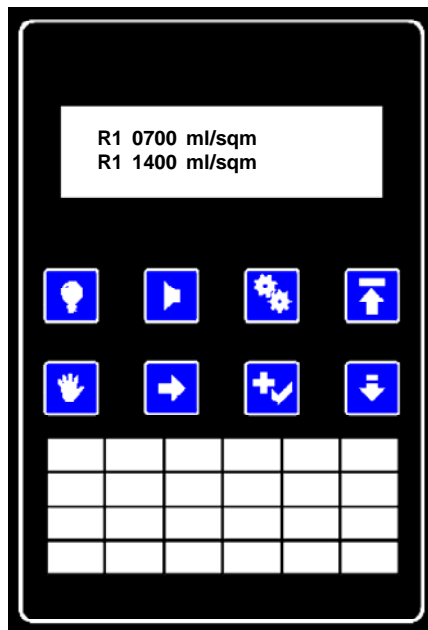
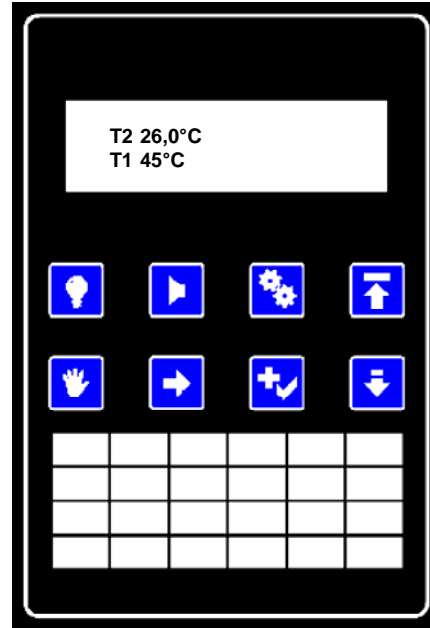
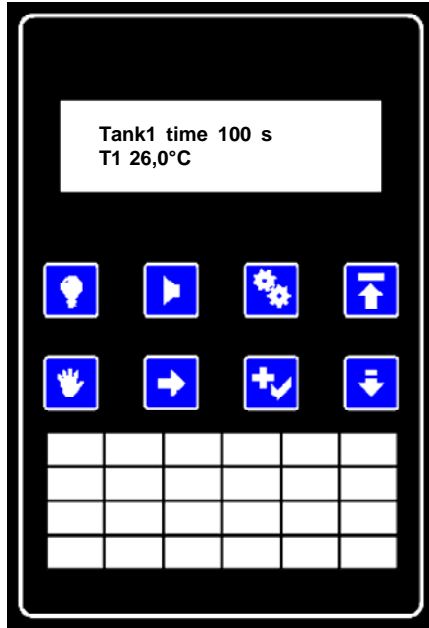

Use **8** to scroll through the pages.

Industrex M43ic / M43icN

To set the parameters, move the cursor with \leftarrow , then change the value with \rightarrow .
Once all digits have been set to the desired value, position the cursor under
Save and press \rightarrow to store the values, or select Cancel to discard the changes.

If any of the values is set too high or too low, when trying to save the programme
you will get.

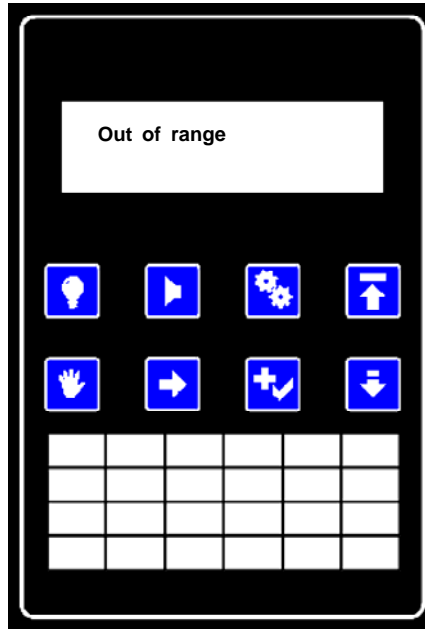

After 2 seconds the message will disappear and you will be taken back to re-programme the values. A parameter that was too high will be automatically reset to the maximum possible value. A parameter that was too low will be reset to the minimum possible value.

This can be used if you want to program extreme values - for instance you want to use the shortest developing time possible, but you don't remember the value. In this case just programme 000. After the "Out of range" message, the developing time will be reset to the minimum. Just select Save once again.

To go back to work mode, press \rightarrow .

**.Note: The Setup menu is just for service and factory setting purposes only.
The Setup-menu set filmprocessor-specific values. This values should not be changed by the costumer.
Although you can select these menus, scroll through the data and even change it, saving the changed data is disabled. Only authorized service technician can re-programme these values.**

5.2 CHANGING THE PROGRAM

To use another programme:

Press 5.
You will see:

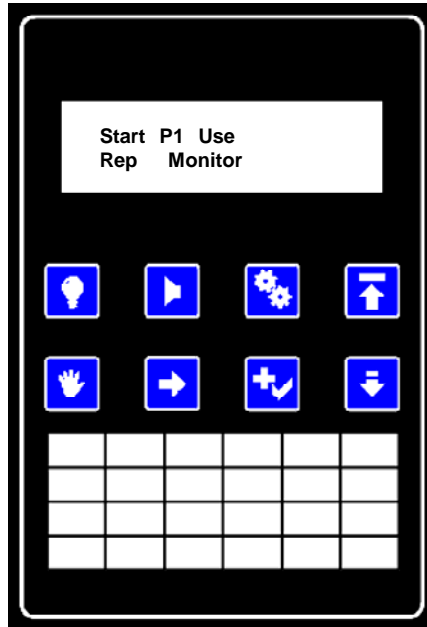

If media is being processed, only the Rep and Monitor items are selectable. Therefore, to switch to another programme you must wait until the processor is empty.

With 6, move the cursor under P1.

Press 7 to change the programme number.

With 6, move the cursor to Use and select it with 7.

Press 4 to jump back to main page.

Note: a cyclic redundancy check is used to verify the data being read from the non-volatile memory. If some damage occurred to the program data, or the programme was never set up properly, you will get an error message Program invalid. The solution is to go to programming mode and re-program the data. This error will occur also if the EEPROM chip has been replaced in which case it contains random data.

5.3 AUTOMATIC MODE

The filmprocessor is designed to work without operator assistance. Under normal circumstances the operator will use the front panel only to check the process parameters and progress.

To scroll through the pages, press .

Press  to jump back to main page.

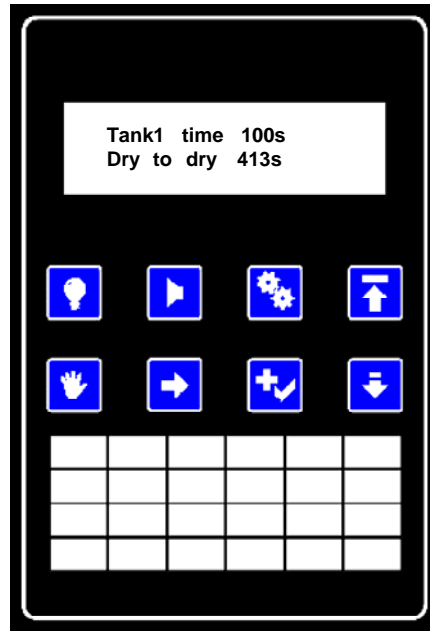
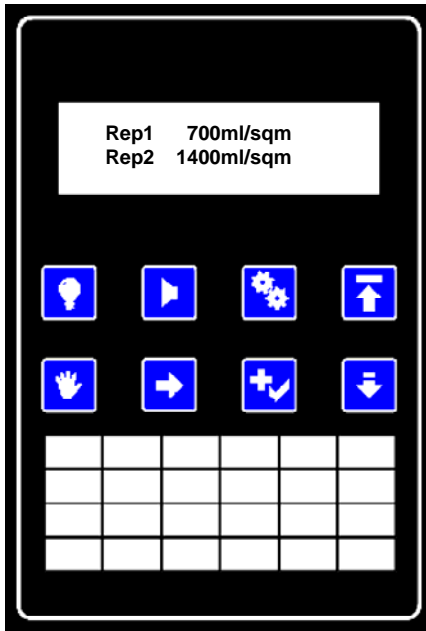
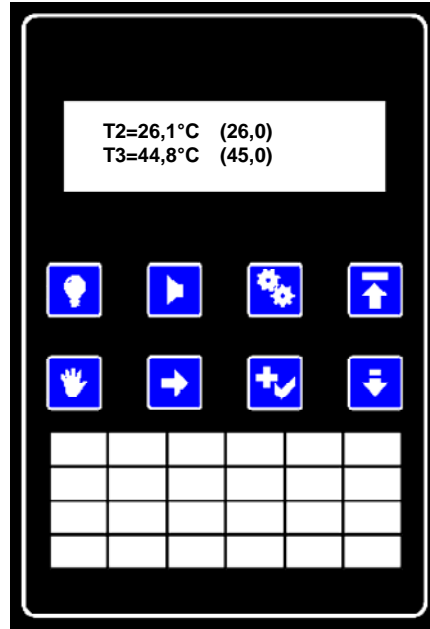
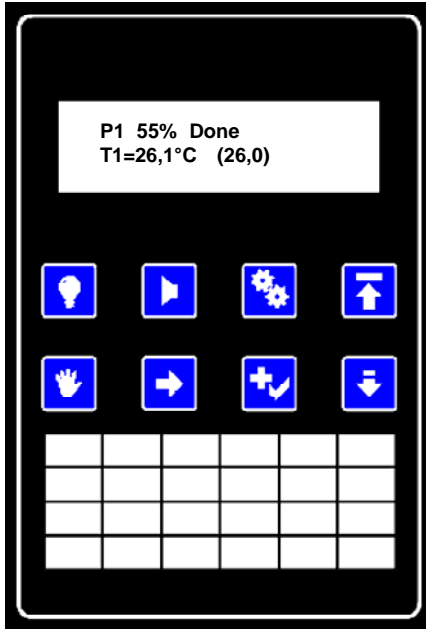

P1 tells you that you are using programme 1. If the filmprocessor was started manually, the indication will be **M1**.

Industrex M43ic / M43icN

55% Done is the progress indicator. It means **55%** of the developing process is complete. When it reaches **100%**, the machine will go to standby.

T1=26,1°C gives you the actually measured temperature in the tank. The value in the brackets is the programmed temperature. The same indication is available for tank **2 (T2)** and for the dryer (**T3**).

Rep1 and **Rep2** are the replenishment rates for the current program.

Tank1 time is the time the media stays in **tank 1**.

Dry to dry is the length of the complete processing cycle (leading edge to heading edge).

Film Speed linear speed of the media inside the filmprocessor.

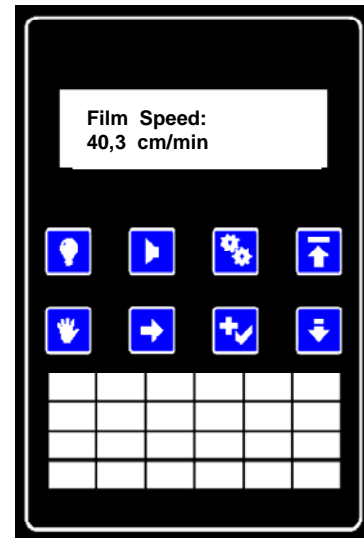

Feeder P- Speed:
0.0 cm/min

Feeder Speed:
speed of the feeder

only when a Colenta AUTO Loader is in use

Film location:
- o - - || - o - -

Film location:
used to monitor the films from the feeder to the filmprocessor.
left side: loader
right side: filmprocessor
-..... no film
o..... film

5.4 STANDBY OPTIONS

The filmprocessor is equipped with an anti-oxidation and a anti-crystallization cycle. That means, when in standby, the processor will start the transport of the rollers and the wash on regular intervals in order to prevent crystallization on the rollers (Anti-crystallization). The anti-oxidation cycle activates, in free programmable time intervals, replenishment cycles. This will prevent oxidation of the the chemistry.

During such a cleaning cycle, the display will look like this.

During such a cycle the filmprocessor will accept media. It's not necessary to wait to the end of the cycle.

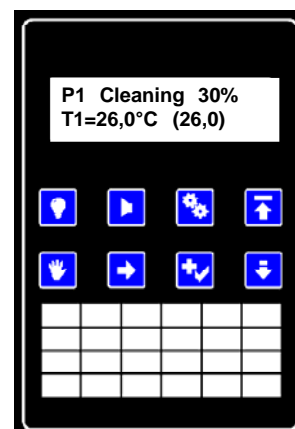

Industrex M43ic / M43icN

Press **3**, use **6** to move the cursor to "**Options**" and press **7**, use again **7** to confirm "**Standby**", by using **8** you can scroll through the pages:

**SB dryer drop
20**

The dryer temp. is 20°C lower than the programmed value.

**SB replenishment
200 ml each 2 h**

The filmprocessor will activate a 200ml replenishment cycle each 2 hours.(Anti-oxidation-cycle)

**SB self-cleaning
20cm each 10min**

The filmprocessor will activate 2,5 roller turns (1 roller turn \cong 8 cm) each 10 min.(Anti-crystallization-cycle)

Save Cancel

5.5 MANUAL REPLENISHMENT CYCLE

You may need to run the replenishment manually, for instance during cleaning. To do this:

Press **5**

With **6**, move the cursor under Rep and select it with **7**.

You will see:

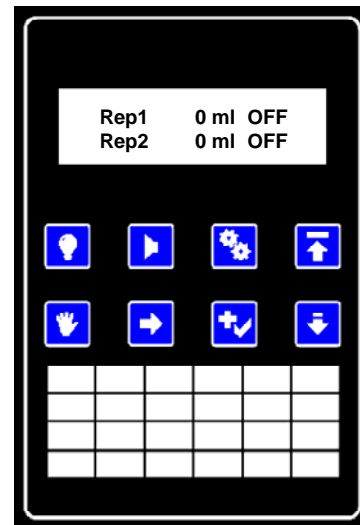

To replenish tank 1

With **6**, move the cursor under Rep1 and press **7**.

This will add **100ml**. The **OFF** indication will change to **ON**, meaning that the replenishment pump is working. If you need more replenishment,

press **7** again to add more replenishment in steps of 100ml. There is no need to wait for the replenishment pump to finish.

For tank 2, move the cursor under Rep2 and repeat the procedure.

Note: Upto 2000ml of manual replenishment or a maximum of 25min pump working time is allowed (whichever is greater).

Press **4** to jump back to main page.

5.6 ERRORS CODES

If an error occurs, the indication P1 (or M1) will alternate with Er. If this happens

Press the **2** button. This will stop the beeper and bring you to the error menu, so you can check what kind of error is indicated. If more than one error occurred, press **0** to scan the rest of them. Press **4** to jump back to main page.

When the filmprocessor switched on at the beginning of the working hours, it is expected to have low temperatures in the tanks. For this reason, the **Er** indication will be present, but without alarm. If, however, the temperature drops during normal work, the alarm will be activated.



Error Messages:

Display	Reason
Tank1 too cold	A:Normal condition during heat-up period. The developer will be heated until the preprogrammed-temperature is reached. B:If an error message is displayed. Call for qualified Service personnel
Tank1 too warm	Developer temperature has gone up more than 1°C above SET-temperature.Call for qualified Service personnel
Tank2 too cold	A:Normal condition during heat-up period. The fixer will be heated until the preprogrammed-temperature is reached. B:If an error message is displayed: Call for qualified Service personnel
Tank2 too warm	Fixer temperature has gone up more than 5°C above SET-temperature.Call for qualified Service personnel
Dryer too warm	Actual temperature in the dryer is more than 5°C above SET-temperature.Call for qualified Service personnel
Motor overload	Hardly running drive/transportssystem. The drive motor did not reach it's SET-speed Call for qualified Service personnel
Tank1 low level	Level Tank1 too low
Tank2 low level	Level Tank2 too low
Water overflow	Drain of watertank is blocked Call for qualified Service personnel
Cover openend	Top cover of the filmprocessor is open.
T1: no probe	Temperature probe in Tank1 is defect or lacks Call for qualified Service personnel
T2: no probe	Temperature probe in Tank2 is defect or lacks Call for qualified Service personnel
T3: no probe	Temperature probe in Dryer is defect or lacks Call for qualified Service personnel
Water low level	Level Watertank is too low.
Can't fill water	After 20 minutes, the watertank should be filled up with water, if the sensor is not reached during this time, the meassage appears. Call for qualified Service personnel
Wrong location	Only possible, if a FEEDER is installed - refer to the „Instruction Manual for the Auto Film Feeder“.
Change filter	The filter medium has to replaced. Call for qualified Service personnel

5.7 MANUAL START/STOP

The manual start/stop is possible only when no media is being processed.

During the processing the corresponding menu items are not selectable - you can't move the cursor there.

To run the motor manually:

Press **5**

With **6**, move the cursor under **Start** and select it with **7**.

This will run the motor. The menu item Start changes to **Stop**.

You can stop the motor by selecting **Stop**.

When you start the motor manually, this will be indicated on the main page as **M1 instead of P1**.

5.8 DISPLAY ILLUMINATION ON/OFF

In a dark room, it might be necessary to switch off the display backlight to prevent exposure. The **1** button toggles the backlight on/off.

When the backlight is off, all the buttons except **1** are disabled.

This is done to prevent pressing buttons by accident in a dark room. Switching the display off is a good idea if the filmprocessor is left unattended. This will reduce the chances for unauthorized people to operate the filmprocessor.

5.9 AUTOMATIC START

The processor will start automatically when media is fed, except in case the developer is too cold - more than 1°C below the programmed. In this case, feeding the media will not start the processor. Instead you'll get the message,

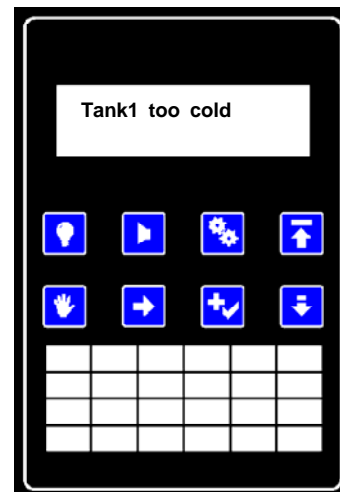

which will disappear after 2 seconds.

If you need to feed a film regardless of the low developer temperature, run the film processor in manual mode.

5.10 DISTANCE BETWEEN FILMS

To prevent film jams, some minimum distance between the films is needed. After the end of the film, the display will show:

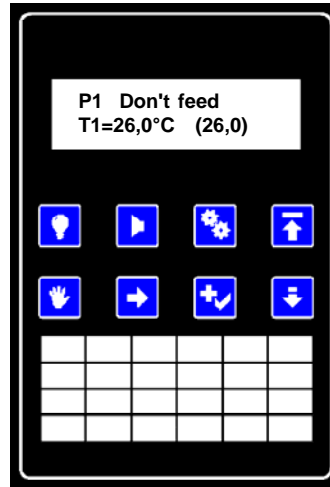

As long as "Don't feed" is present, it's not allowed to feed films. After a while "Don't feed" will disappear and a beep will indicate that the input is free again.

5.11 MONITOR MODE:

The "Monitor Program" is used to check some different parameters of the filmprocessor.

Press the bottom **5**, you will see: **Start P1 Use Rep Monitor**, move the cursor by using **6** under **Monitor** and confirm with **7**

the first page looks like this:

```
DDDDFFFFWWWWDDDD
---  --
```

This represents the filmprocessor, the first four DDDD are the developer tank, FFFF - fixer tank, WWWW - water and the last DDDD is the dryer.

The dashes on the second row indicate where in the filmprocessor there are pieces of material.

The water is turned on only if there is a film in the specified portion of the filmprocessor, that saves water and protect the environment.

Each film is tracked inside the machine. The software can track up to 70 films.

Note that two films running in parallel are considered as one. For the filmprocessor, different films are pieces of material separated by completely free sensorbar.

Industrex M43ic / M43icN

**Motor Off / On
Speed 19 001**

Motor is **On** or **Off**
19 speed
001 re-impulses from the motor

**Normal s-bar
Area=0.0000 sqm.**

A normal 6-sensor sensorbar is recognized
Value of the given filmaera until to the next
replenishment cycle

**S-bar: -----
-----**

This feature is used to check each sensor of the sensor-bar. In the processor there are 6 sensors integrated. To check the sensors, follow the instructions underneath:

- put a small film under the sensorbar (don't feed into the filmprocessor)
- move the film as shown underneath
- at the same time take a look to the display

**S-bar: -----
-----10**

That means sensor 1 and 0 are occupied

**S-bar: -----
-----32--**

That means sensor 3 and 2 are occupied

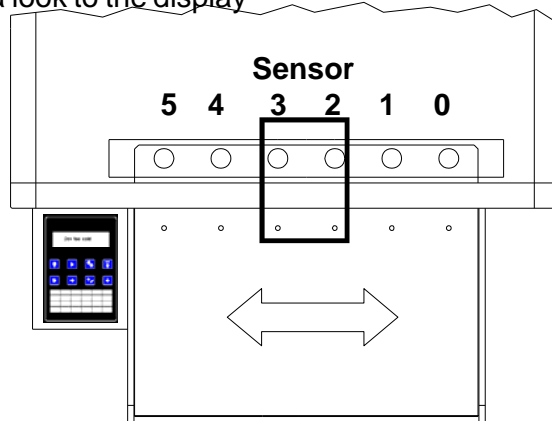

**H1=0 H2=0 Hd1=1
Hd2=0 Fan=1 Ws=1**

H1=1 or 0	heater tank1 On or OFF
H2=1 or 0	heater tank2 On or OFF
Hd1=1 or 0	heater dry 1 On or OFF
Hd2=1 or 0	heater dry 2 On or OFF
Fan=1 or 0	Dryer fan On or OFF
Ws=1 or 0	Wash valve On or OFF

**Refill1 0000
Refill2 0000**

see "Automatic Developer and Fixer tank fill" on page 27

5.12 FILTER CONTROL:

Version 2.7 is equipped with a sub-program to control the filter unit of the developer:

Press the bottom 3 , use 6 to move the cursor under "Options", press 7 , you will see "Standby Refill Filter" use again 6 to move the cursor under "Filter", press 7 you will see:

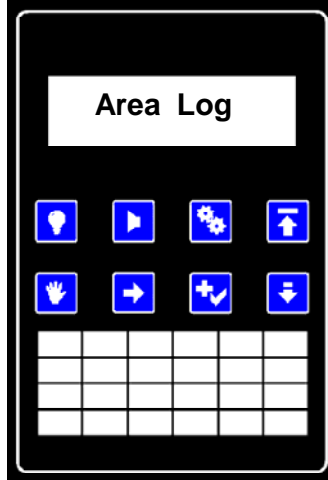

The Area menu sets the amount of square meters before filter alert. The value is 0000-9999. A value of 0000 turns off the filter alert.

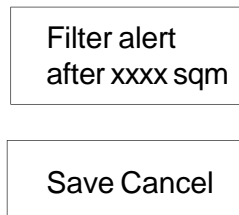

The Log menu shows the total area processed so far. This value is stored in the NVRAM. The value is updated each time a replenishment is initiated. It depends on the „Replenish after“ variable from the setup.

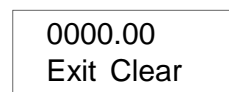

For example if Replenish after = 0.125sqm, the total processed area will be increased by 0.125 sq.m. at each replenishment.

At each replenishment the total processed area is checked for exceeding the alert value. When the value has been exceeded, an error message appears „Change filter“.

WARNING: Call for qualified service personnel. The filter may be exchanged by qualified service personnel only.

After changing the filter, the user must go to programming mode menu Options/Filter/Log and clear the processed area, so the area will be counted from 0 for the new filter.

5.13 ADDITIONAL FEATURES - REFILL WATER / CHEMISTRY

The software includes the following features:

- 1 - Automatic wash tank fill / automatic wash tank draining
- 2 - Automatic Developer and Fixer tank fill (see next page)

1 - Automatic wash tank fill / automatic wash tank draining

This feature ensures that the water level in the wash tank is at the normal level on „start-up“ and then to drain automatically on shut down. This is accomplished by the use of an additional level sensor in the wash tank to inform the filmprocessor controller on the level of water in the tank and the use of an electrically controlled drain valve that will remain „closed“ when the filmprocessor is in use and „open“ when the filmprocessor is shut down. On morning „start-up“ the drain valve will be closed and the water „fill“ solenoid will open to allow water to pass into the wash tank until reaching normal operating level. If the wash tank does not reach normal level within 20 minutes (level switch not activated) the electronics will assume that there is a water supply problem and the error message „ can't fill water“ will be displayed. (see page 21 for further information).

The following instructions will activate or de-activate this feature:

Press the bottom 3 , use 6 to move the cursor under "Options", press 7 , you will see "Standby Refill" use again 6 to move the cursor under "Refill", press 7 you will see:

Wash auto refill
1 (1=yes,0=no)

use 7 to set 1 or 0. After that procedure, use (3x) 8 to leave the menu, the controller will ask you : Save Cancel choose save by using 7 .

2) Automatic Developer and Fixer tank fill.

This feature automatically corrects for low level conditions in the Developer and Fixer chemical tanks by way of additional level switch monitoring circuits.

If either tank „low level“ tank sensor is activated a replenishment cycle will inject solution (**XXml**) into the chemical tanks until the correct tank level is reached.

** XXml** this amount is programmable and relates to the size of filmprocessor.
(see the table : factory settings)

In the case of a leak from the tank or the associated circulation system and to avoid the replenishment pumps operating continuously thereby draining and wasting replenishment chemistry there is an inbuilt fail safe system that will disable the replenishment pump if the level in the tank is not reached after 2000ml of replenishment. The pump will stop and the message „Tank - Low Level“

Use the following procedure to activate or de-activate the feature:

Press the bottom 3 , use 6 to move the cursor under "Options", press 7 , you will see "Standby Refill" use again 6 to move the cursor under "Refill" you will see:

Wash auto refill 1 (1=yes,0-no)	(page before)
------------------------------------	---------------

Use (1x) 8 you will see:

	no refill	300ml refill
T1 auto refill add 0000 ml		T1 auto refill add 0300 ml

In this case, the automatic chemistry tank fill is deactivated, to activate, you have to set a value instead of 0000. To do this, use the following procedure:

Move the cursor under the "zeros" by using 6 , to set a value, use 7 .

To leave, use (1x) 8 you will see:

T2 auto refill add 0000 ml

Use the same procedure for Tank2 as described before for Tank1.

After you set that all, use (1x) 8 to leave the menu, the

controller will ask you :

Save	Cancel
------	--------

 choose save by using 7 .

6. TEMPERING SYSTEM

The filmprocessor employs an indirect tempering system to maintain processing solution temperatures accurately and efficiently. This tempering system is integrated into the recirculation. This system offers more efficiency and energy-saving.

The control panel in turn activates the circulation pumps and the tempering unit. The circulation pumps mix the chemistry to ensure even temperature throughout the entire tank. The drive motor also comes on during this period, to prevent build-up of chemical by-products on the processing rack parts during period of low usage. As protection against overheating most of the filmprocessors are equipped with a „cold water“ cooling system.

7. TEMPERATURE SENSING

The temperature probe in the tank senses the temperature change and activates the relevant heater control circuits within the main processor control system so as to maintain accurate solution temperatures.

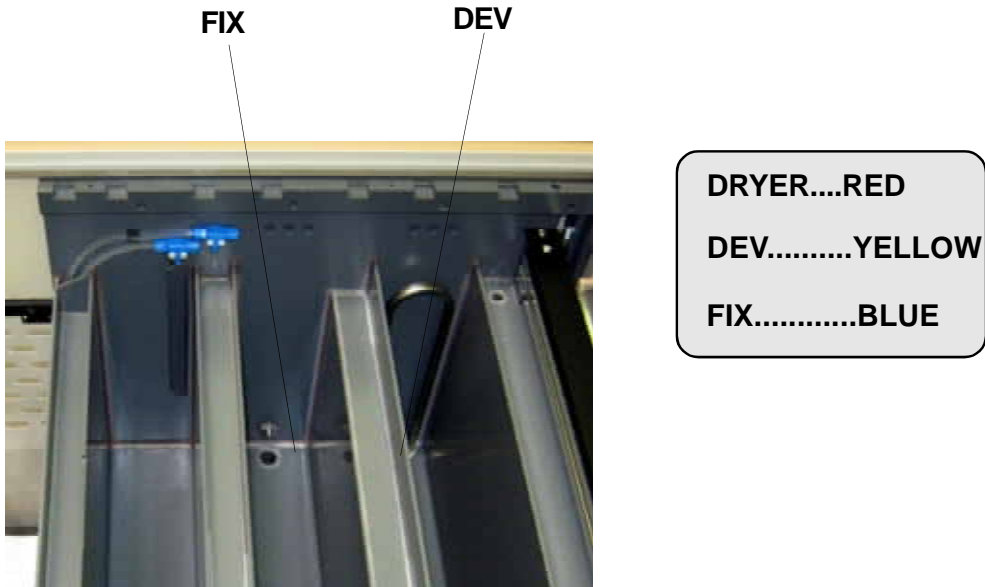

8. I2C-BUS SYSTEM

Probes positioned under solution levels precisely monitor all solution tank temperatures. These temperature probes are continuously supplying information to the microprocessor on actual solution temperatures within the tanks. The microprocessor then compares these actual temperatures to the required programmed "set" temperatures and controls the relevant heaters/cooling systems accordingly.

Bus-System	Measurement	Action
Temp.-probe	Developer Temp. Fix Temp.	Heating/Cooling Heating/Cooling
Sensorbar	Dry Incomming plate-area	Heating Replenishment

NOTE: To transfer this information, a BUS-SYSTEM is installed.

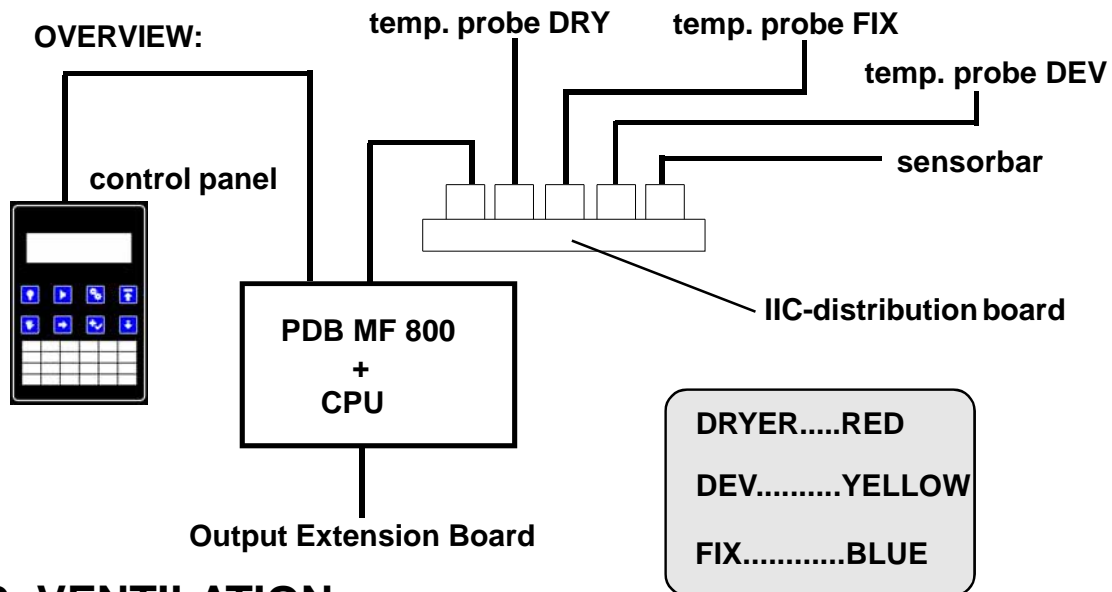

9. VENTILATION

To prevent cristalization and humidity inside the filmprocessor a ventilation divice is fitted to processor. It is recommended to connect the below mentioned tube to an external exhaust device to prevent any possible problems.

WARNING: To install such a external exhaust device, is allowed for qualified Service personnel only.



ventilations holes



tube with cover lid

10. CHEMICAL REPLENISHMENT SYSTEM

Whenever photographic material is processed, chemical components of the processing solutions are used and by-products are left behind in the processing solutions. Replenisher solutions are formulated to restore the chemistry to its original activity and to dilute the by-products to a correct level. It is therefore necessary to add the proper amount of replenisher for the amount of material that has been processed. Performed automatically by the filmprocessor by way of infrared sensors installed across the complete feed width of the filmprocessor.

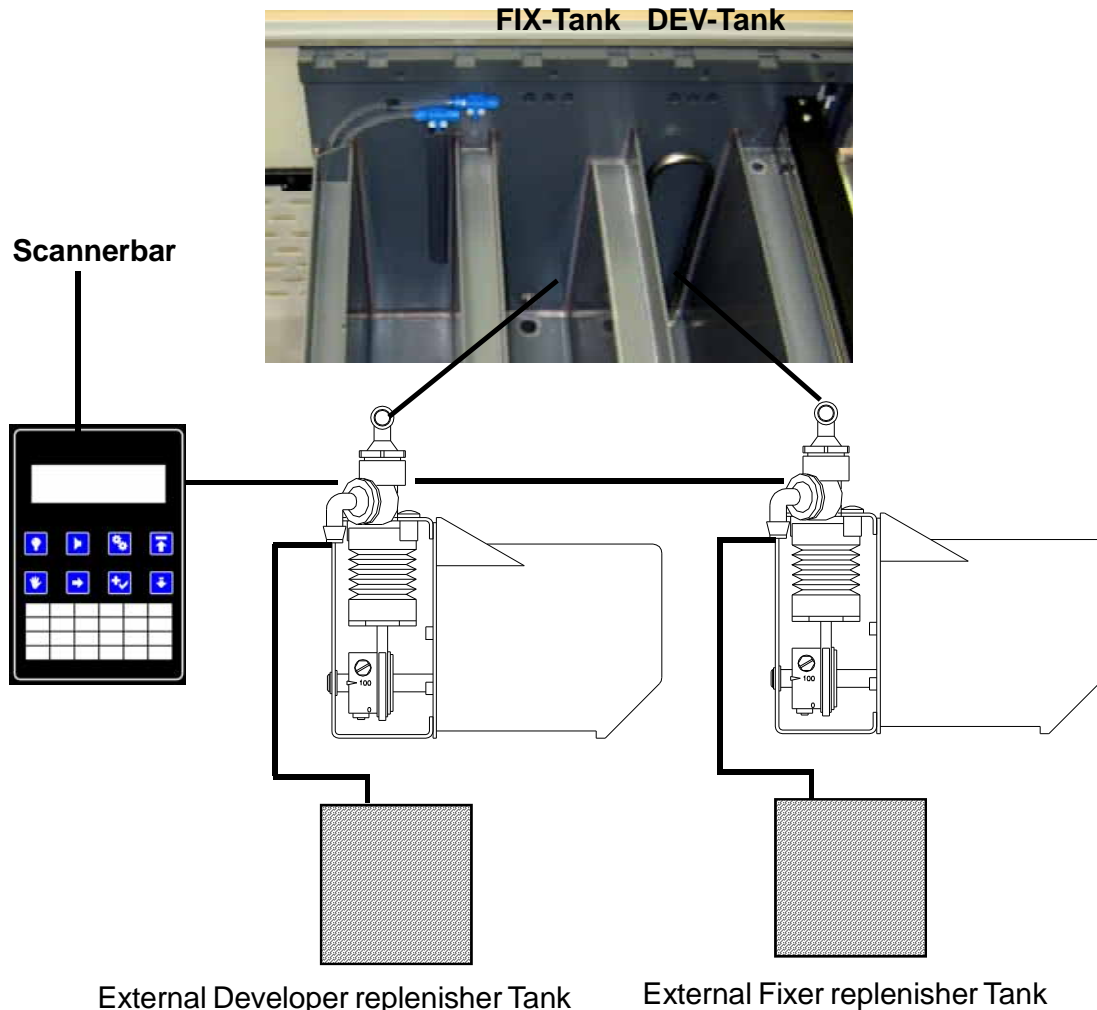

These sensors emit pulses of infrared light which has no effect on photographic emulsions. When media is beneath the sensorbar, the pulses are reflected and detected by the sensor. The pulses are transmitted to the control panel where they are „counted“ by the microprocessor. When the number of pulses reaches the amount that has been programmed on the microprocessor, the replenishment timer function starts.

The replenishment timer runs the replenishment pump(s) for the number of seconds that have been set on the microprocessor. When the replenishment pumps are activated, the replenisher solutions are pumped through filters located at the bottom of the external replenisher tanks to the chemistry tank. The replenisher tanks are outside of the film processor.

The filters should be checked monthly and be cleaned or replaced if necessary.

WARNING: Separate the Film Processor from mains. To do so, switch the main power switch of the processor to „0“ position. Wear safety goggles, protection gloves and clothing.

10.1 INFRARED REPLENISHMENT SENSORBAR

The automatic replenishment system is using an infrared-sensor-bar to detect the incoming film area. With that information the CPU of the filmprocessor will calculate the replenishment rate which will be need.



Sensorbar with Infrared sensors

IMPORTANT: Special care must be taken to ensure that the processor entrance rollers are always clean and dry – any spillage of chemical or water onto the feed tray / feed rollers or sensor bar must be avoided. Any spillage must be cleaned immediately.

The "holes" in the film input guide show you the position of the sensors.

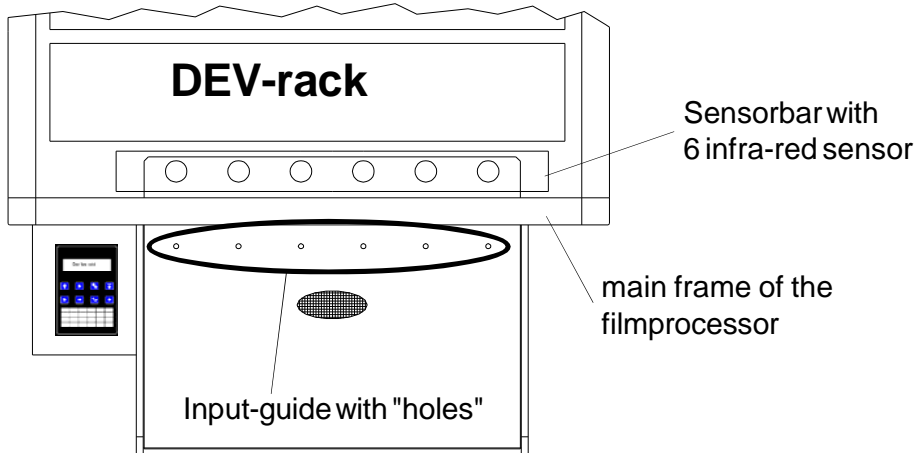

To process rollfims, take care to the following points:

- use a leader
- take care that the film will be detect by minimum 1 sensor

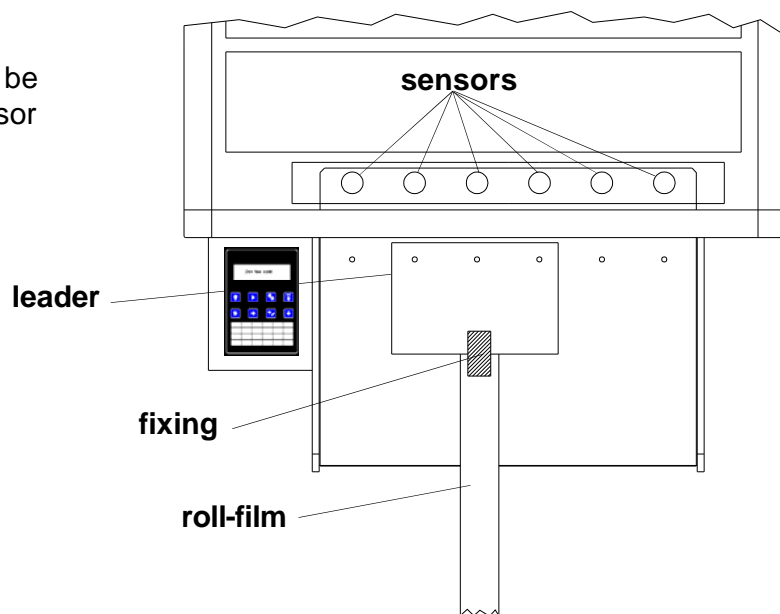

11. MAINTENANCE

The filmprocessor is designed to produce consistent high quality production with the minimum of maintenance.

Regular maintenance minimizes the chances for equipment failure and loss of processing quality. A well trained person has to be responsible for performing the maintenance of the filmprocessor and must be familiar with the operation and function of the processor as well.

1. Daily maintenance

- *) Check levels of the external replenishment tanks - If necessary mix fresh solution.
- *) Cleaning feed tray.
- *) Cleaning spray-bar-guide for the fixer
- *) Before starting production we advise to feed some cleaning films to remove any overnight residue.
- *) Use the supplied "spray-bottle" to remove any deposits from the drive gears - as shown below:



Spray-bottle

2. Weekly maintenance

- *) Wipe external surfaces of film processor / enclosures / panels with a wet cloth to remove any chemical / dirt deposits.
- *) Inspect and clean the wash tank and intermediate water rins drains. If algae present then they should be removed, in such a case we suggest to use a proven algae control system
- *) Check the shown drain pipes and overflow tubes - remove any deposits to prevent blockage of the drain.

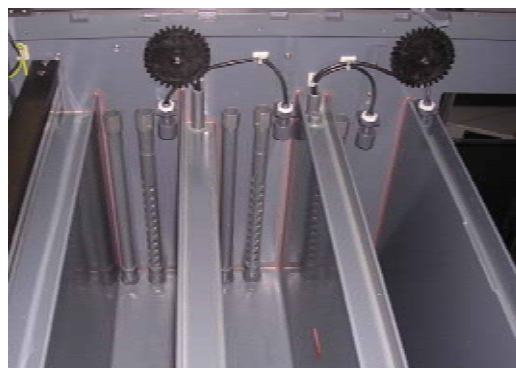

12. RECOMMENDED MAINTENANCE EVERY 3-6 MONTHS (Period is subject to filmprocessor useage.)

Good processing quality and the reliable operation of a filmprocessor is dependent upon regular and careful cleaning. Every 3-6 months, the chemicals in the tanks should be drained. A chemical cleaning of the processing tanks and wash tank is recommended. Always follow safety warnings as described in section 1 when cleaning the filmprocessor.

Prior to **carrying out any maintenance**, switch off the power at the main power switch (position "0") ensuring it cannot be accidentally switched back on.

- *) Switch off the main power switch of the film processor first (position „0“).
- *) Remove the top cover of the filmprocessor.
- *) Drain individual tanks by open the draitaps in front of the filmprocessor.
- *) Remove rack assemblies (water / DEV / FIX, see item 2.1) and put them aside.
- *) Close taps and fill all tanks with water or better with suitable cleaning solution until the red mark inside the tanks are reached.
- *) Put the racks back into the tanks of the filmprocessor and close the top cover.
- *) Switch on the filmprocessor and start some replenishment cycles. The hoses will be cleaned with water as well. Also start the transport of the filmprocessor, the racks has to be in. Let the filmprocessor run for 10 to 15 minutes.
- *) Switch off („0“ position)the main power switch of the filmprocessor and drain the filmprocessor tanks again.
- *) NOTE: Use cleaning solution according to the manufacturer´s instructions.
- *) After tank cleaning, the developer- and wash-tank should be filled twice with fresh water (eventually use neutralizer recommended by manufacturer). Let the filmprocessor run for approximately 10 minutes again. Check all external (outside of the filmprocessor) hose connectors (outside of filmprocessor) and fittings for leaks.
- *) Drain all tanks.
- *) Remove the water / DEV / FIX Racks and check for:
 - worn gears
 - damaged or worn bearings
 - loose screws
 - scratched or bent film guides
 - plastic flat springs in developer bottom underturn.

- *) All repairs must be carried out by qualified service personnel.
- *) Check the inside of the tank for contamination and alien substances.
- *) Clean the rollers well.
- *) Close the drain taps of all 3 tanks.
- *) Fill developer and fixer tanks with fresh chemicals to the required level (1st fixer, 2nd developer)
- *) Fill wash tank.
- *) Re-install the racks carefully. Take care of correct sequence of the racks is followed and make sure the gears are in the right position. Secure the racks.
- *) Insert the respective suction pipe to the correct external replenisher tank.
Re-install the top cover and switch on the filmprocessor.
- *) Process test films.

13. TROUBLE SHOOTING

Problem	Possible cause	Correction
1. Error message: Tank1 too cold Developer temperature more than 1°C below set temperature	A) Developer bath temperature too low B) Heater problem C) No circulation in the bath	A) Please check Heat up time- Check Dev -Temp in 2-3min 1°C temperature increase B) In Monitor programm H1 must on, LD 3 on main board on and check Fuse F3 C) Please check circulation pump, LD7 on main board on and check fuse F7
2. ERROR message : Tank1 too warm Developer temperature more than 1°C above set-temperature	A) Cooling doesn't work B) Water tap closed	A) Check the cooling assembly, LD9 on mainboard on and check Fuse F9 B) Open water tap
3. ERROR message : Tank2 too cold Fixer temperature more than 1°C below set-temperatur	see point 1	see point1 LD4 F4
4. ERROR message : Tank2 too warm Fixer temperature more than 1°C above set-temperatur	see point 2	see point 2
5. ERROR message : Dryer to warm Dryer temperature more than 5°C above set-temperature	A) Set temperature too low (lower than room temperature) B) main board defective C) Solid State	A) Change set temperature B) Change main board C) Solid State Relais defective
6. ERROR message: Motor overload the drive motor did not reach it's Set-speed	A) Main Drive assembly blocked B) Main drive chain to much tension	A) Check the main drive for easy running B) Please call service
7. ERROR message: Cover opened The cover of the machine is not closed	A) The cover of the machine is not closed correctly	A) Check the machine cover

Industrex M43ic / M43icN

Problem	Possible cause	correction				
8. Main drive and dryer run continuously	A) Main drive was started in "manual mode"	A) Check in the manual programm if "STOP" is shown stop the transport with button. <u>Attention:</u> if also an automatic cycle is started by the sensor bar this cycle will end first.				
	B) Material always under sensorbar. Material not transported/pulled into the processor	B) Check the Input rubber roller. Check the film cassette.				
	C) Sensor/s at the sensorbar dirty	C) Clean the sensor/s				
	D) Main board defective	D) Call service/change main board				
9. Material wet when exiting processor	A) Dryer temperature too low	A) increase the dryer temperature (max. 60°C)				
	B) Transport speed to high	B) Lower the transport speed				
	C) Unusable or wrong Developer or Fixer	C) Increase the Repl.rate or change the chemicals				
	D) Dryer blows only cold air	D) Fuse F1 of the dryer heater defective or solid state relais				
10. Temperature problems Temperature is shown incorrect.	The temperature probes has to be positioned according their coding.	1. The temperature probeS are colour coded				
		<table border="0"> <tr> <td>yellow</td> <td>Developer</td> </tr> <tr> <td>blue</td> <td>Fixer</td> </tr> <tr> <td>red</td> <td>Dryer</td> </tr> </table>	yellow	Developer	blue	Fixer
yellow	Developer					
blue	Fixer					
red	Dryer					

Industrex M43ic / M43icN

Problem	Possible cause	correction
11. No fresh water supply	A) Water tap is closed B) Watervalue is blocked or faulty C) main board defective D) Fuse is faulty	A) Open water tap B) Clean the small filter in the valve, or exchange it C) Call service/change main board D) Change fuse F8
12. Circulation pump don't work	A) Pump wheel is blocked by dirt B) Fuse faulty	A) Clean the pump wheel and make shure easy running B) Change fuse F7
13. Level in water tank too high, watertank overflows	A) Water drain/overflow blocked B) Worse water drain installation	A) Clean the water tank and clean the overflow and the water drain. B) change the water drain installation
14. Level in Developer- or Fixertank too low.	A) Tank leaks B) Too low replenishment rate or too long anti ox. cycle C) Replenishment container empty D) Replenishment pump faulty E) Drain taps leaks	A) Seal the tank leak/call service B) Increase the replenishment rate or decrease the Anti ox cycle time C) Fill up the replenishment containers D) Clean the replenishment pump or exchange it E) Close drain taps/ replace drain taps

Industrex M43ic / M43icN

problem	possible cause	correction
15. CHEMICAL TEMPERATURE CANNOT BE REACHED	A) Incorrect temperature	A) Program the temperature correctly.
	B) Temperature sensor is faulty.	B) Replace the temperature sensor.
	C) The processor was started without liquid in tanks. The safety fuses at the heating element have interrupted the current supply.	C) Reset the safety fuse.
	D) PDB is faulty.	D) Replace PDB.
16. SCRATCHES OR PRESSURE MARKS	A) Unsuitable handling of the processing materials.	A) Handle material carefully.
	B) Cross over rollers are dirty.	B) Clean all rollers above fluid level.
	C) Bent guide bars	C) Clean and check guide bars. If necessary, replace.
17. MATERIAL REMAINS IN THE PROCESSOR	A) Material fed incorrectly.	A) The material must be fed in straight.
	B) Material has excessive curl.	B) Fold leading edges and feed in the processor.
	C) Material is too thin.	C) Adhere leader films.
	D) Rollers aren't rotating.	D) Check gears and the position of the loose rollers.
18. PROCESSOR COULD NOT BE SWITCHED ON	A) Main cable isn't plugged.	A) Plug in main cable correctly.
	B) Main fuse is faulty.	B) Check main fuse.

Industrex M43ic / M43icN

problem	possible cause	correction
19. PAPER OR FILM TOO LIGHT	A) Bath temp is too low	A) Adapt the bath temperature to the recommended process or change chemistry.
	B) Transport speed is too high.	B) Decrease transport speed.
	C) Exposure time is too short.	C) Increase exposure time.
	D) Bath level is too deep (no heating and circulation)	D) Fill bath to the right level. Check Replenish-tanks.
	E) Developer exhausted	E) Replenish or change chemistry.
	F) Fixer getting into developer (Dev becomes cloudy)	F) Carefully clean the tank and replace chemistry.
	G) Exposure settings are incorrect or machine is faulty.	G) Adjust setting or repair faults.
20. PAPER OR FILM TOO DARK	A) Developer temperature is too high.	A) Decrease developer temperature.
	B) Processing time is too slow.	B) Increase processing time.
	C) Exposure time is too long.	C) Reduce exposure time.
	D) After new chemistry: starter is missing.	D) Add starter according to instructions.
21. PAPER OR FILM IS FOGGED	A) Light leak in darkroom or cassette	A) Seal off light leak.
	B) Incorrect darkroom light	B) Check filter, wattage and distance from the darkroom lamp to the processor.
	C) Material is outdated.	C) Check date of maturity.
22. PAPER OR FILM HAS YELLOW-GREEN SURFACE	A) Unsuitable hand processing material is used.	A) Only use material suitable for roller processing.
	B) Fixer is exhausted.	B) Replenish or change chemistry.
	C) Level of fixer bath has dropped (Temperature safety fuse has been activated).	C) Check level of the replenishment containers. Fill up the bath to the required level.
	D) Circulation pumps have failed.	D) Check the pump motor. Eventually replace it.

NOTES

NOTES

NOTES
