

# NDT Supply.com, Inc.

7952 Nieman Road  
Lenexa, KS 66214-1560 USA

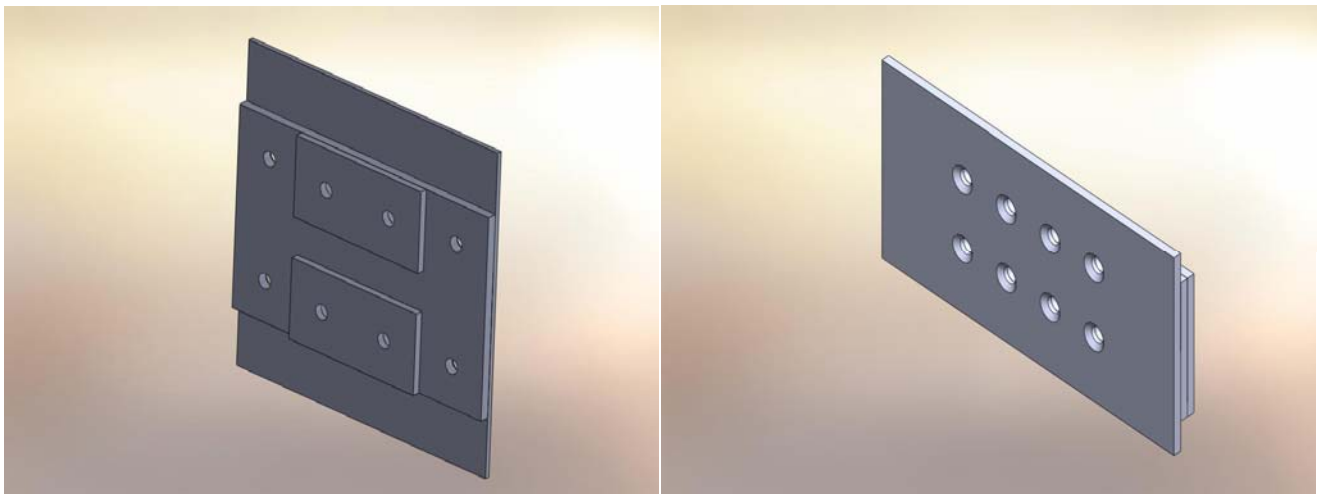

## Aircraft Calibration Standards For Ultrasonic and Eddy Current Inspection of Boeing, Airbus and McDonnell Douglas



In addition to the calibration standards shown in this catalogue we are able to supply calibration standards made to your specifications. Please send us a copy of your drawings for a price quotation.

Riveted standards are supplied without rivets installed.

Phone: 913-685-0675  
Fax: 913-685-1125

[sales@ndtsupply.com](mailto:sales@ndtsupply.com)  
[www.ndtsupply.com](http://www.ndtsupply.com)



## Boeing - Aircraft Ultrasonic and Eddy Current Standards

**Note:**

Contact us for a price and delivery quotation.

If you do not find the standard you need below, please send us detail drawings for price and delivery.

**Part No :** 189

**Purpose :**

737 NTM 51-00-00 PART 6 FIG. 4  
PAGE 13

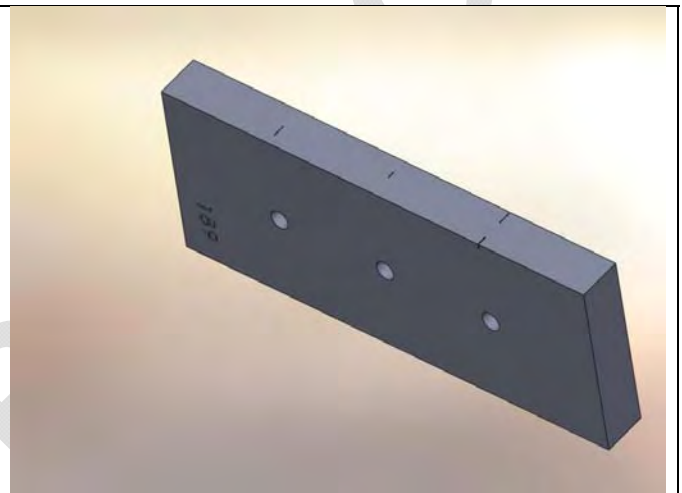

**Part No :** NDT 3092

**Purpose :**

737 NTM 53-10-05 PART 4 PAGE 8

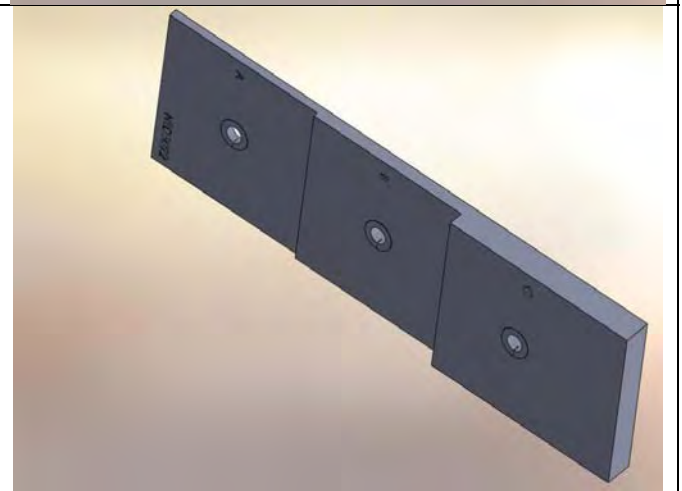

# NDT Supply.com, Inc.

7952 Nieman Road  
Lenexa, KS 66214-1560 USA



**Part No :** NDT 512

**Purpose :**  
757 NTM 57-10-01 PART 4 FIG.3  
PAGE 7

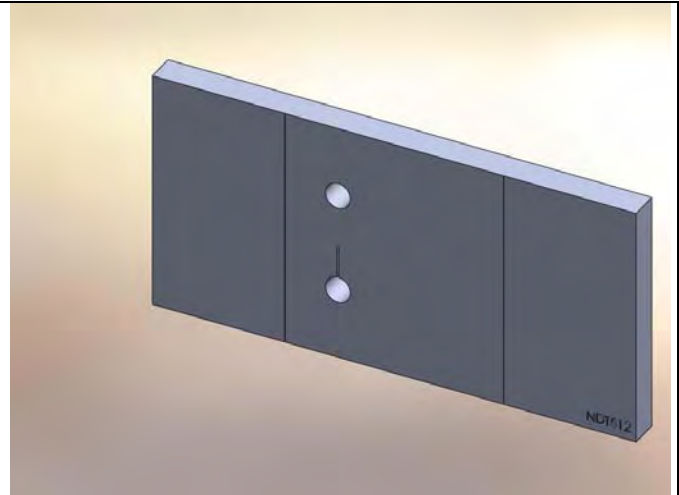

**Part No :** NDT 514

**Purpose :**  
757 NTM 57-20-01 PART 6 FIG. 2  
PAGE 8 and 9

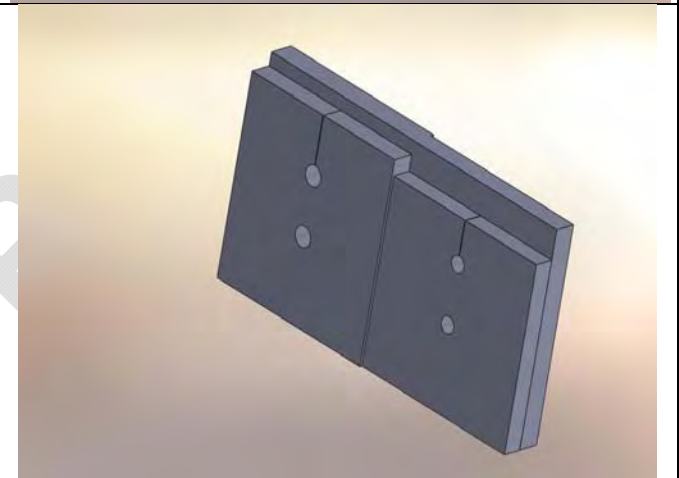

**Part No :** NDT 515

**Purpose :**  
757 NTM 57-20-01 PART 4 FIG. 3  
PAGE 7

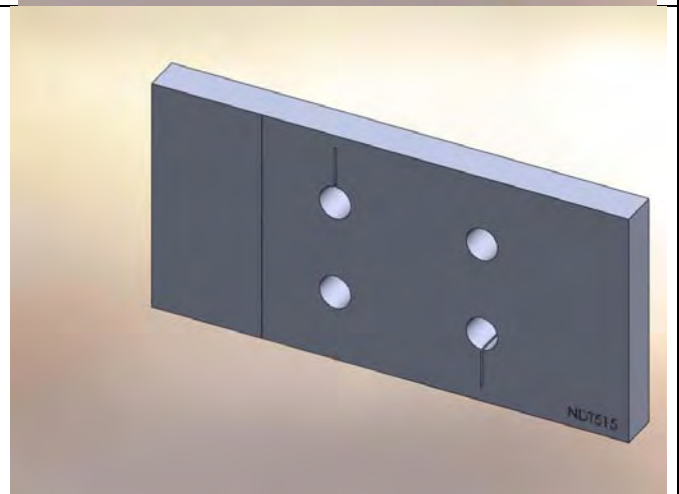



<p><b>Part No :</b> NDT 516</p> <p><b>Purpose :</b> 757 NTM 57-23-01 PART 6 FIG. 1 PAGE 4</p>	
<p><b>Part No :</b> NDT518</p> <p><b>Purpose :</b> Ultrasonic Inspection Reference standard 757 NTM: 57-21-02 Part 4 Fig. 2 Page 4</p>	
<p><b>Part No :</b> NDT 519</p> <p><b>Purpose :</b> 757 NTM 52-30-01 PART 6 FIG. 4 PAGE 10</p>	

# NDT Supply.com, Inc.

7952 Nieman Road  
Lenexa, KS 66214-1560 USA



**Part No :** NDT520

**Purpose :**  
Eddy Current Inspection Reference  
standard  
757 NTM: 52-30-02 Part 6 Fig.2  
Page 8

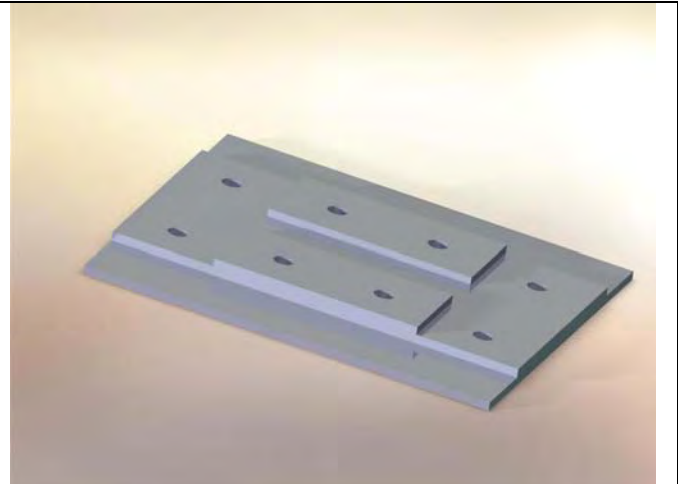

**Part No :** ANDT 1079-ANDT1082

**Purpose :**  
NDT 53-30-00 PART 6 FIG. 7  
PAGE 8

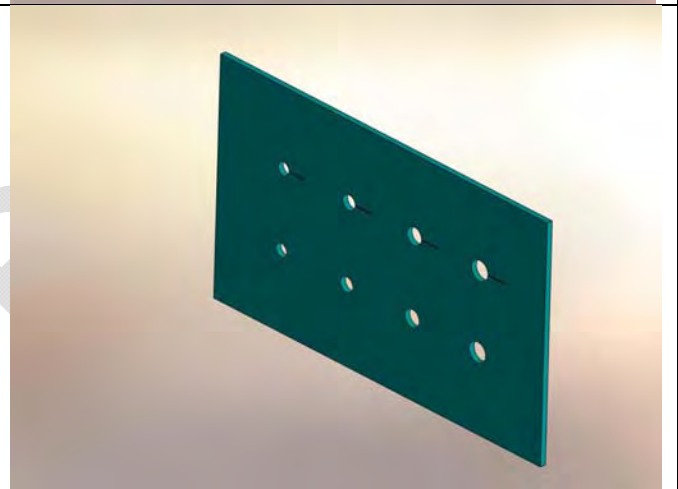

**Part No :** 53-19-11

**Purpose :**  
Reference Standard 53-19-11

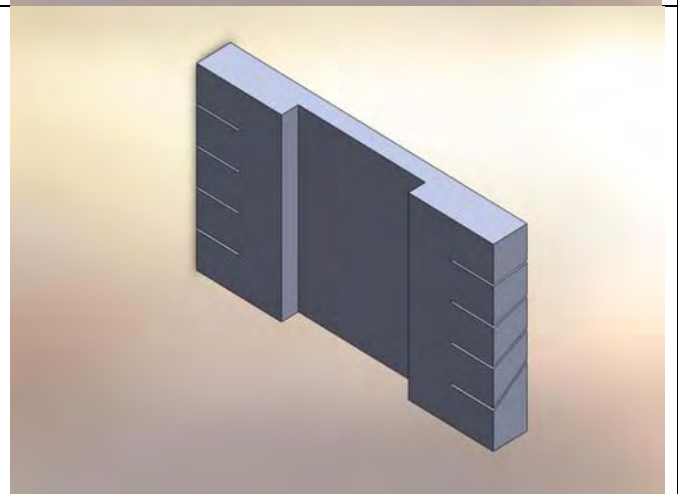



# NDT Supply.com, Inc.

7952 Nieman Road  
Lenexa, KS 66214-1560 USA



**Part No :** 53-30-10

**Purpose :**  
Reference Standard 53-30-10

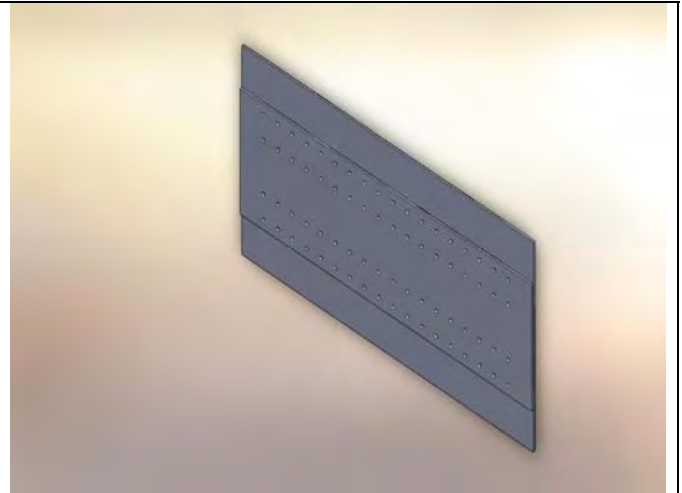

**Part No :** 53-38-00

**Purpose :**  
Reference Standard 53-38-00

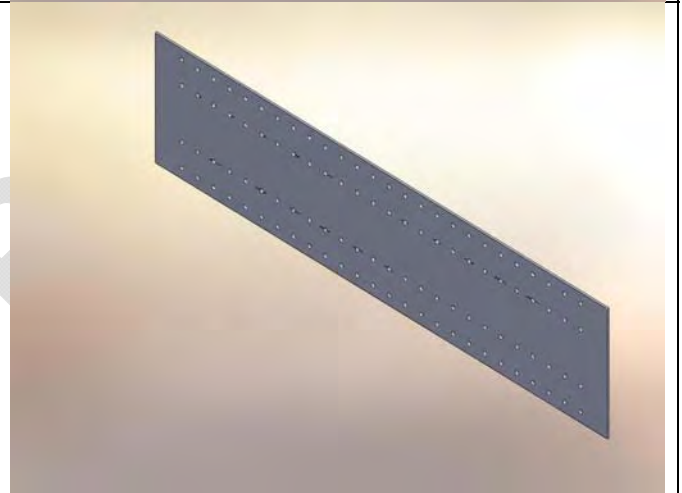

**Part No :** 57,25,26

**Purpose:**  
Reference Standard 57,25,26<sup>1</sup>

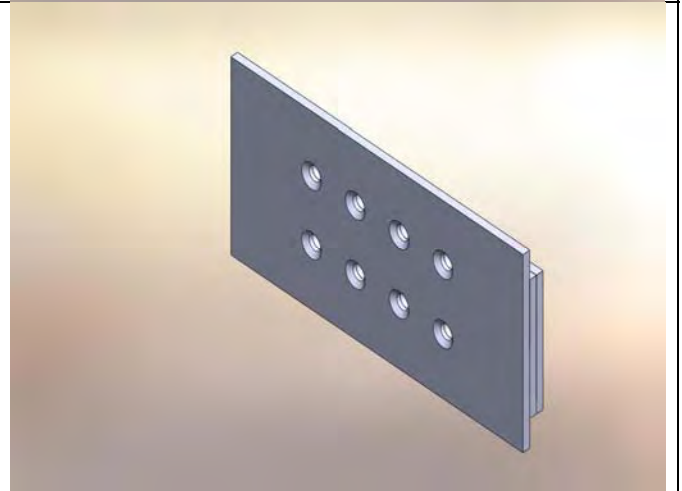

# NDT Supply.com, Inc.

7952 Nieman Road  
Lenexa, KS 66214-1560 USA



**Part No :** NDT 3050

**Purpose :**  
Reference Standard NDT 3050

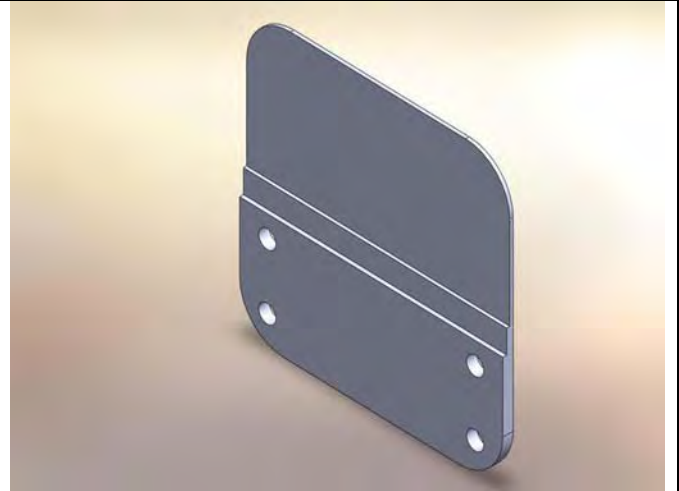

**Part No :** 99A53107269000

**Purpose :**  
A300 NTM 53-10-39

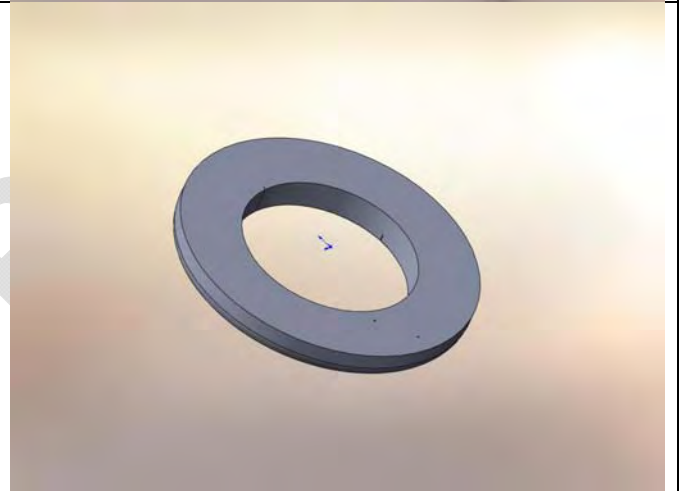

**Part No :** NDT3024A

**Purpose :**  
737 NDT 53-10-04 PART 4 FIG. 3  
PAGE 10

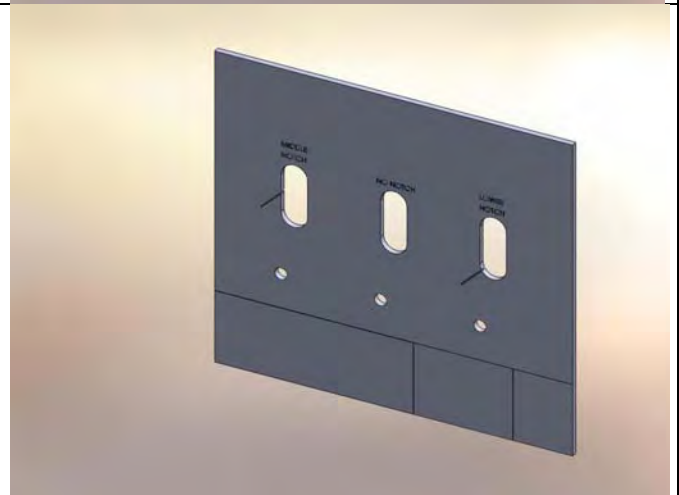



**Part No :** NDT3050

**Purpose :**  
737 NDT 53-30-20 PART 6 PAGE 6

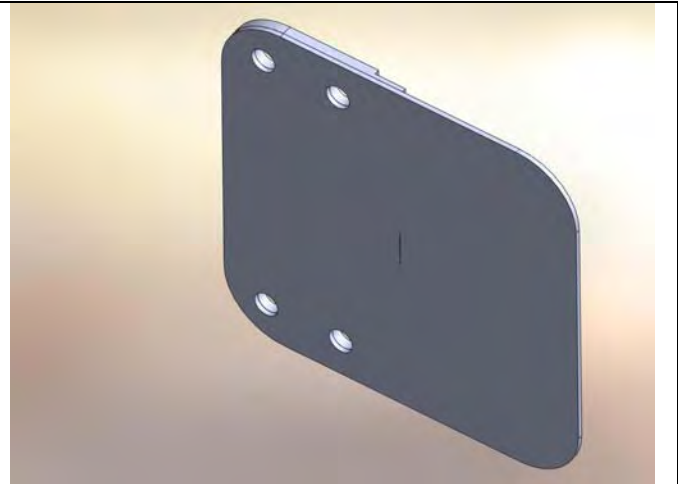

**Part No :** NDT 3038

**Purpose :**  
737 NDT 57-50-02 PART 4 PAGE 8  
FIG. 4

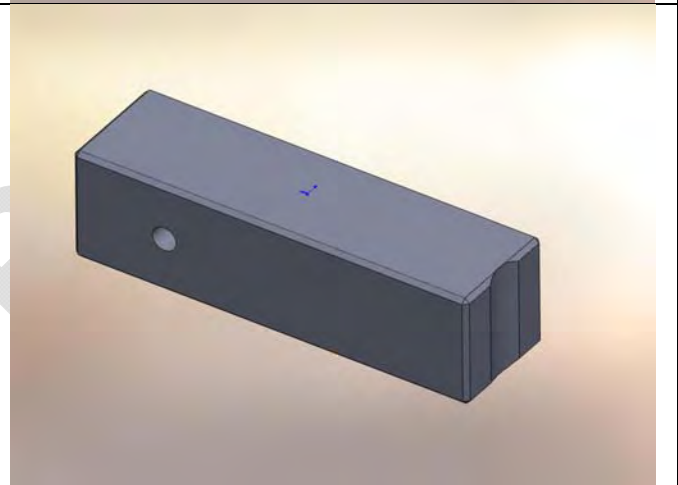

**Part No :** NDT3023

**Purpose :**  
737 NDT 32-10-02 PART 4 PAGE 11  
FIG. 5

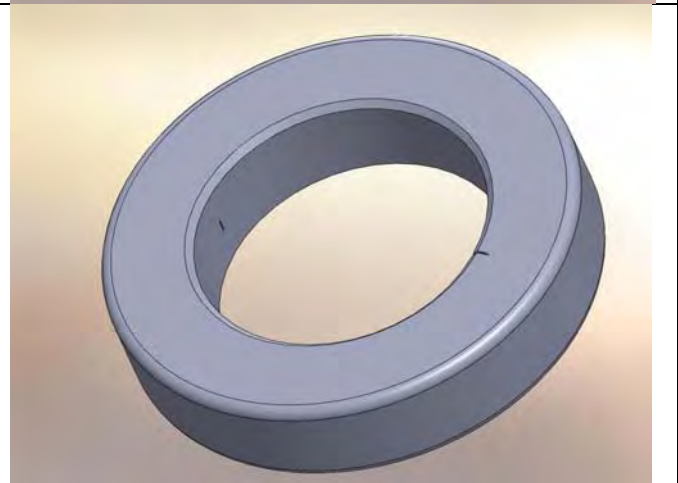





**Part No :** NDT3001

**Purpose :**  
737 NDT 53-10-02 PART 4 PAGE 8  
FIG. 2

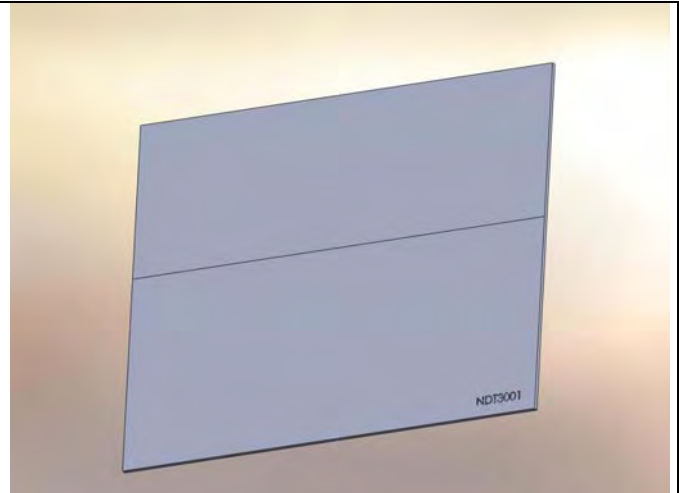

**Part No :** NDT392

**Purpose :**  
737 NDT 53-30-03 PART 4 PAGE 7  
FIG. 2

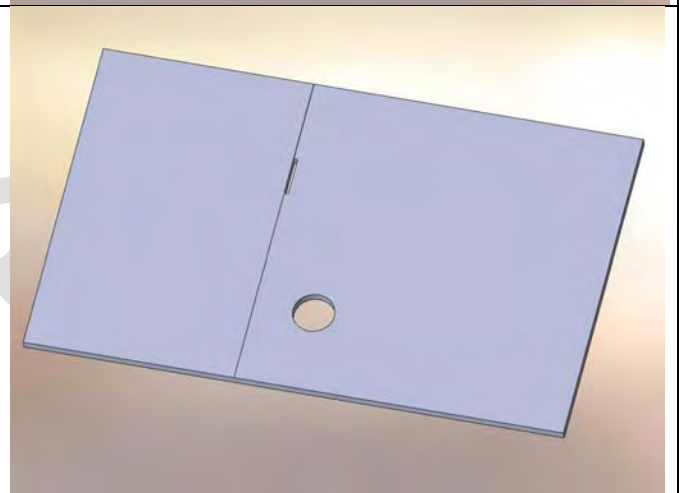

**Part No :** NDT1039-T1/T2

**Purpose :**  
737 NDT 53-30-01 PART 4 PAGE 5  
FIG. 2

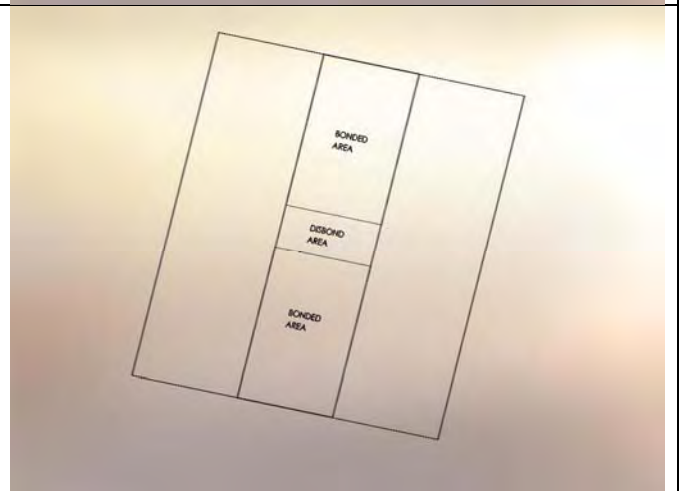

# NDT Supply.com, Inc.

7952 Nieman Road  
Lenexa, KS 66214-1560 USA



## Airbus - Aircraft Ultrasonic and Eddy Current Standards

**Note:**

Contact us for a price and delivery quotation.

If you do not find the standard you need below, please send us detail drawings for price and delivery.

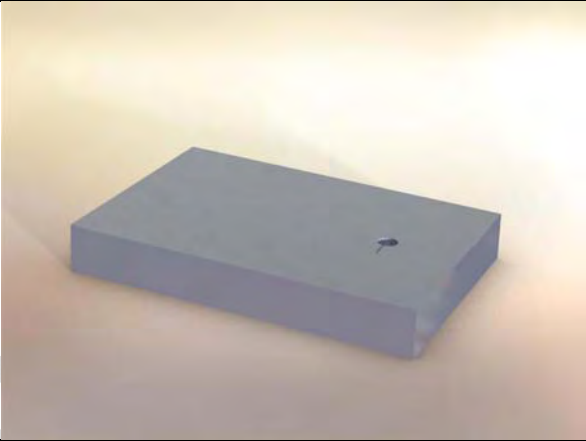
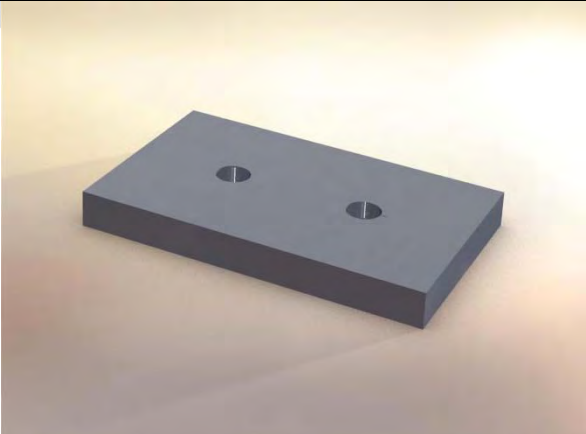
<p><b>Part No :</b> 99F53303020000 <b>Purpose</b> Ultrasonic Inspection Reference standard A300 NTM PART 4, 53-12-04 Page 404</p>	
<p><b>Part No :</b> 99D57103002000 <b>Purpose :</b> Ultrasonic Inspection Reference standard A300 NTM PART 1, 57-11-85 Page 401</p>	

# NDT Supply.com, Inc.

7952 Nieman Road  
Lenexa, KS 66214-1560 USA



<p><b>Part No :</b> 99D57204107000 <b>Purpose :</b> Ultrasonic Inspection Reference standard A300 NTM PART 1, 57-21-10 Page 406-407</p>	
<p><b>Part No :</b> 98A52003000 <b>Purpose :</b> Ultrasonic Inspection Reference standard A300 NTM PART 4, 52-82-11 Page 4</p>	
<p><b>Part No :</b> 98A52003001 <b>Purpose :</b> Ultrasonic Inspection Reference standard A300 NTM PART 4, 52-82-11 Page 5</p>	

# NDT Supply.com, Inc.

7952 Nieman Road  
Lenexa, KS 66214-1560 USA



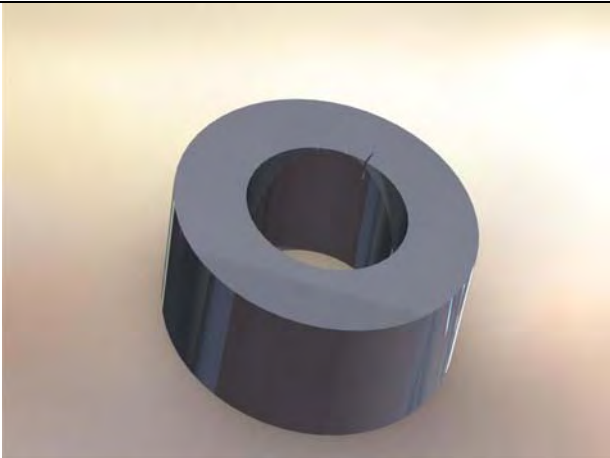
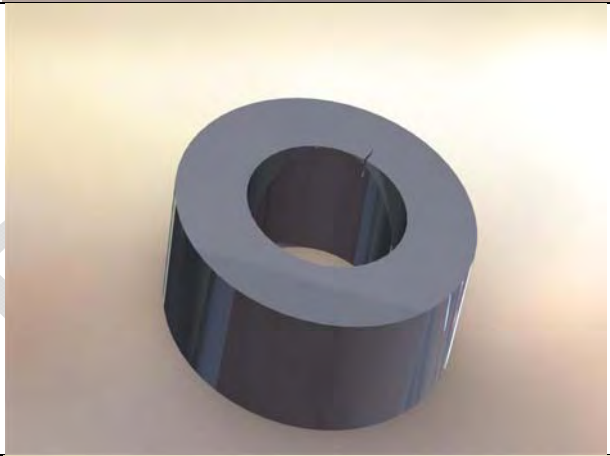
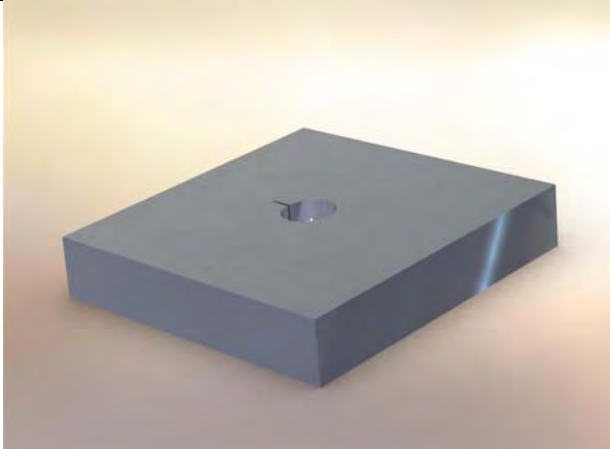

<p><b>Part No :</b> 98A52003002 <b>Purpose :</b> Ultrasonic Inspection Reference standard A300 NTM PART 4, 52-81-12 Page 2</p>	 A 3D CAD rendering of a cylindrical ring with a central hole. The ring is dark grey and is shown from a perspective view, highlighting its thickness and the circular opening.
<p><b>Part No :</b> 98A52003004 <b>Purpose :</b> Ultrasonic Inspection Reference standard A300 NTM PART 4, 52-82-11 Page 6</p>	 A 3D CAD rendering of a cylindrical ring with a central hole, identical in design to the one in the first row. It is shown from a perspective view against a light background.
<p><b>Part No :</b> 98A53803018000 <b>Purpose :</b> Ultrasonic Inspection Reference standard A300 NTM PART 4, 53-12-00 Page 4</p>	 A 3D CAD rendering of a square block with a small circular hole in its top surface. The block is dark grey and is shown from a perspective view, showing its thickness and the square shape.

# NDT Supply.com, Inc.

7952 Nieman Road  
Lenexa, KS 66214-1560 USA

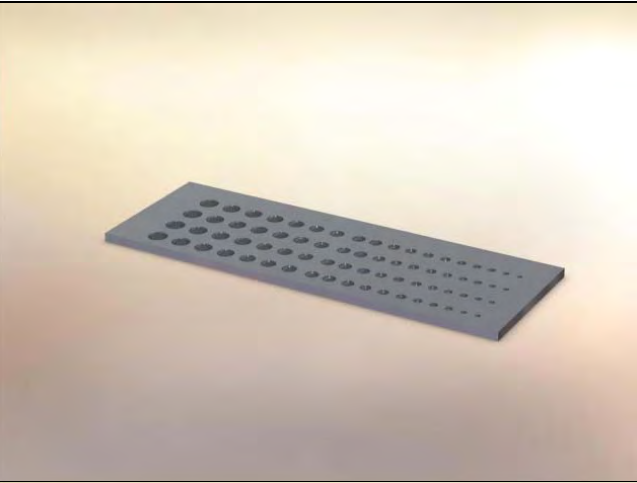
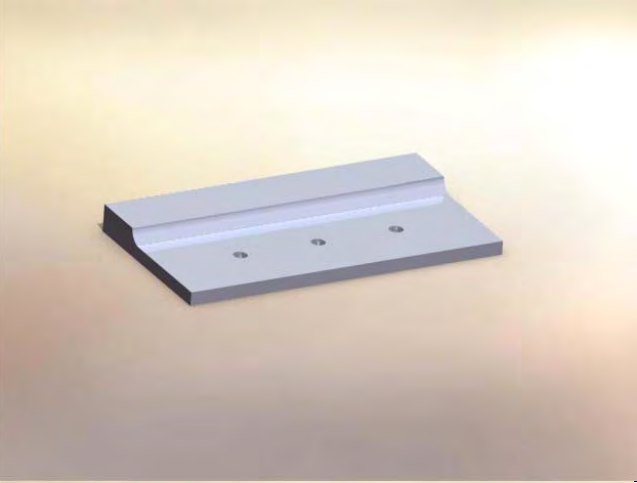

<p><b>Part No :</b> 99A53003001101 <b>Purpose :</b> Eddy Current Inspection Reference standard A300 NTM PART 1, 51-34-05 Page 1</p>	 A rectangular metal plate with a grid of small circular holes on its surface, used as a reference standard for eddy current inspection.
<p><b>Part No :</b> 99A53803009000 <b>Purpose :</b> Ultrasonic Inspection Reference standard A300 NTM PART 4, 53-15-11 Page 9</p>	 A rectangular metal plate with a raised edge and three small circular holes on its surface, used as a reference standard for ultrasonic inspection.
<p><b>Part No :</b> 99A54403002000 <b>Purpose :</b> Ultrasonic Inspection Reference standard A310 NTM PART 4, 54-40-01 Page 5</p>	 A rectangular metal plate with a raised edge and two small circular holes on its surface, used as a reference standard for ultrasonic inspection.



# NDT Supply.com, Inc.

7952 Nieman Road  
Lenexa, KS 66214-1560 USA



**Part No :** 99A57103005002  
**Purpose :**  
Ultrasonic Inspection Reference  
standard  
A310 NTM PART 4,  
57-10-47 Page 406

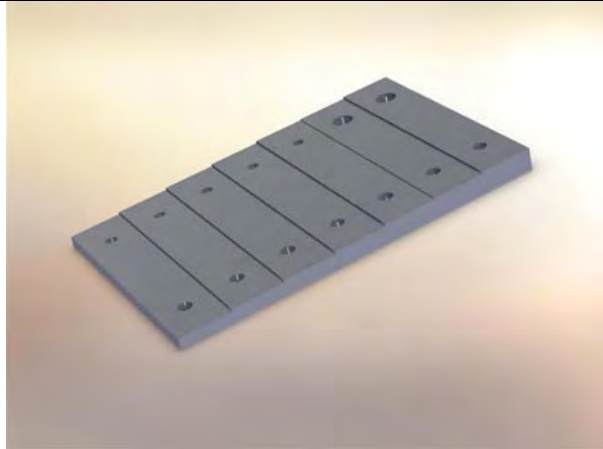

**Part No :** 99A57103007000  
**Purpose :**  
Ultrasonic Inspection Reference  
standard  
A300-600 NTM PART 4, 57-10-39  
Page 404

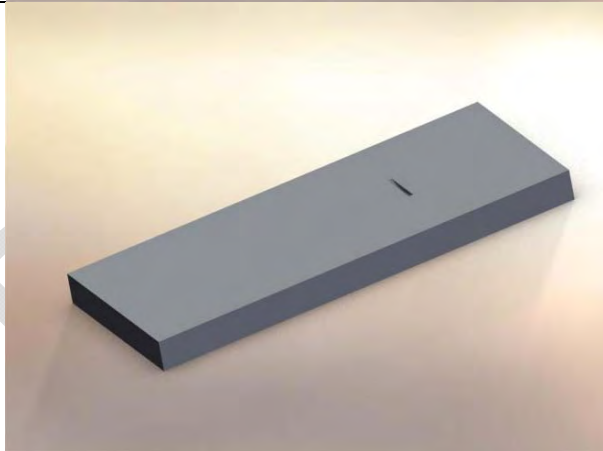

**Part No :** 99A57103010000  
**Purpose :**  
Ultrasonic Inspection Reference  
standard  
A300 NTM PART 4,  
53-15-22 Page 6

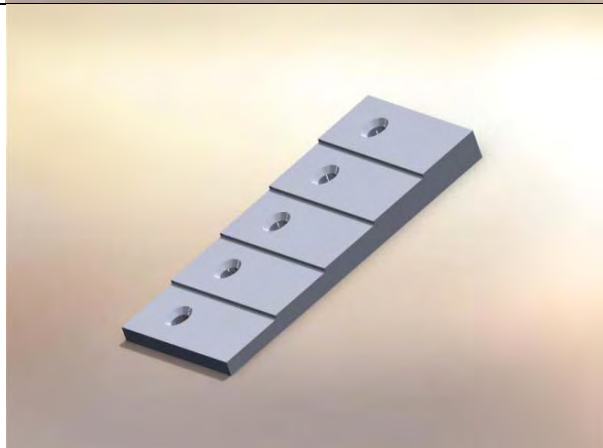

# NDT Supply.com, Inc.

7952 Nieman Road  
Lenexa, KS 66214-1560 USA



**Part No :** 99A57103011000  
**Purpose :**  
Ultrasonic Inspection Reference  
standard  
A300 NTM PART 4,  
53-15-22 Page 7

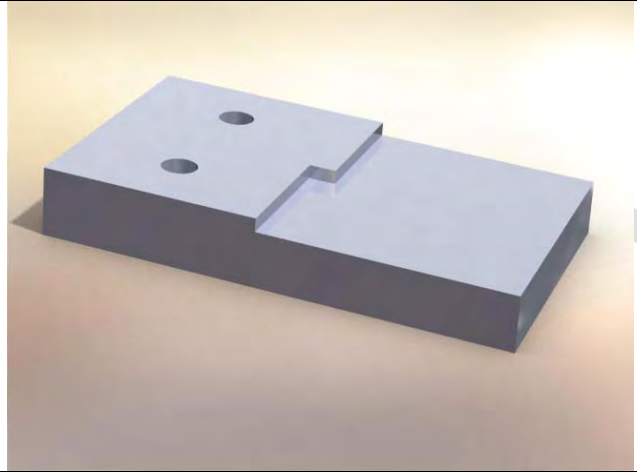

**Part No :** 99A57103012000  
**Purpose :**  
Ultrasonic Inspection Reference  
standard  
A300 NTM PART 4,  
53-15-22 Page 8

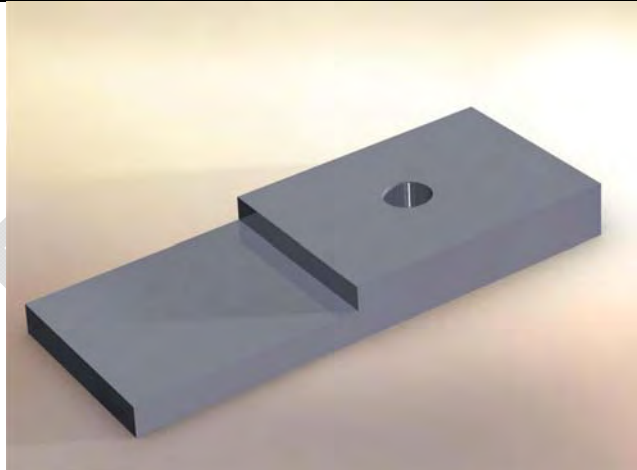

**Part No :** 99A57103025001  
**Purpose :**  
Ultrasonic Inspection Reference  
standard  
A300 NTM PART 4,  
53-15-20 Page 6

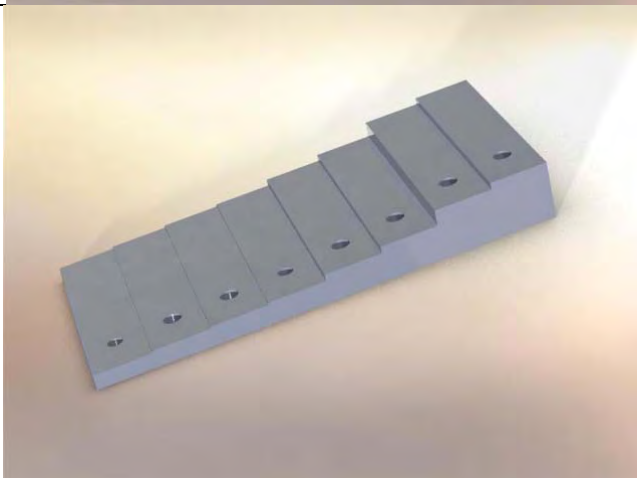



**Part No :** 99A57103028000  
**Purpose :**  
Ultrasonic Inspection Reference  
standard  
A300-600 NTM PART 4, 57-10-22  
Page 404

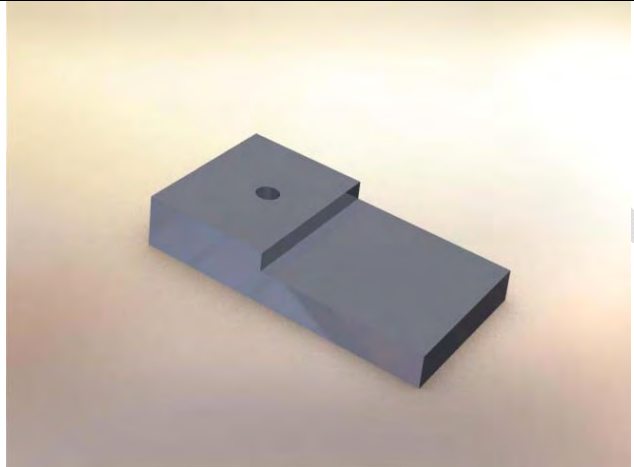

**Part No :** 99A57103029000  
**Purpose :**  
Ultrasonic Inspection Reference  
standard  
A300-600 NTM PART 4, 57-10-06  
Page 404

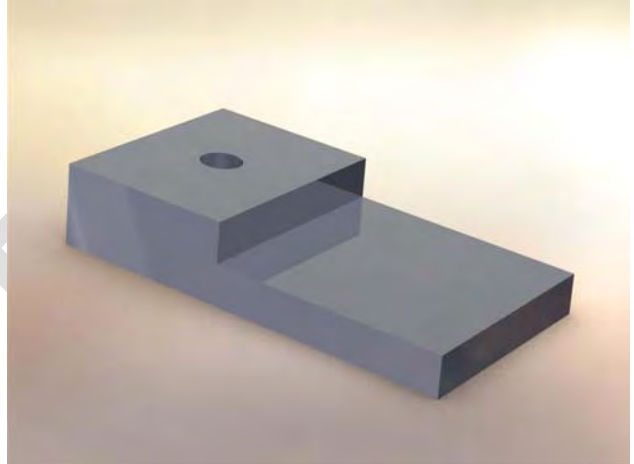

**Part No :** 99A57103031000  
**Purpose :**  
Ultrasonic Inspection Reference  
standard  
A300-600 NTM PART 4, 57-10-06  
Page 405

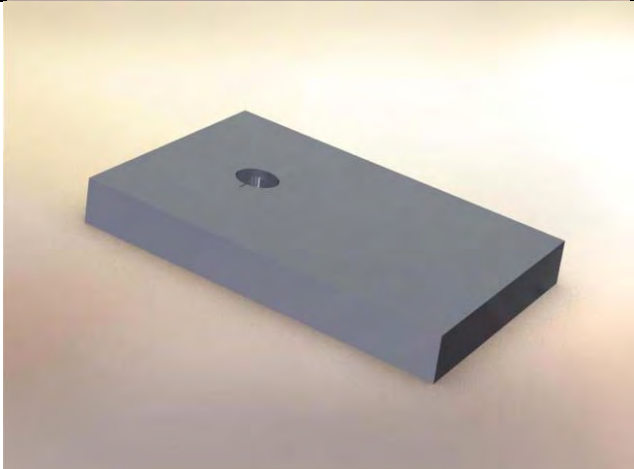

# NDT Supply.com, Inc.

7952 Nieman Road  
Lenexa, KS 66214-1560 USA



<p><b>Part No :</b> 99A57103033000 <b>Purpose :</b> Ultrasonic Inspection Reference standard A310 NTM PART 4, 57-10-26 Page 405</p>	
<p><b>Part No :</b> 99A57104331000 <b>Purpose :</b> Ultrasonic Inspection Reference standard A300 NTM PART 4, 57-13-11 Page 22</p>	
<p><b>Part No :</b> 99A57104332000 <b>Purpose :</b> Ultrasonic Inspection Reference standard A300 NTM PART 4, 57-11-16 Page 14</p>	

# NDT Supply.com, Inc.

7952 Nieman Road  
Lenexa, KS 66214-1560 USA



**Part No :** 99A57104333000  
**Purpose :**  
Ultrasonic Inspection Reference  
standard  
A300 NTM PART 4,  
57-11-16 Page 15

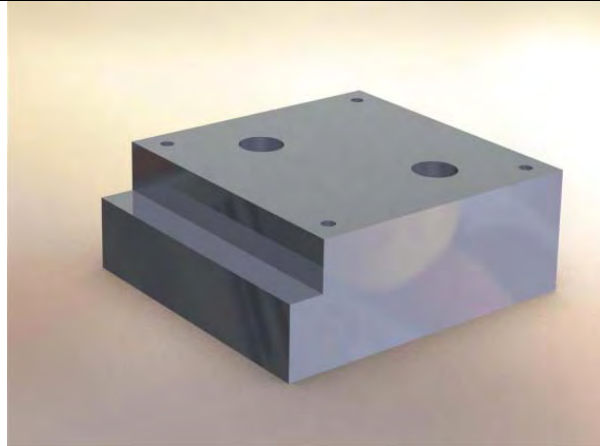

**Part No :** 99A57104334000  
**Purpose :**  
Ultrasonic Inspection Reference  
standard  
A300 NTM PART 4,  
57-11-16 Page 16

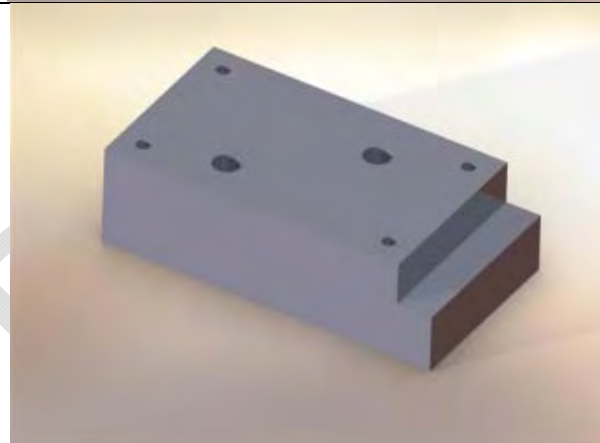

**Part No :** 99A57104335000  
**Purpose :**  
Ultrasonic Inspection Reference  
standard  
A300 NTM PART 4,  
57-11-21 Page 15

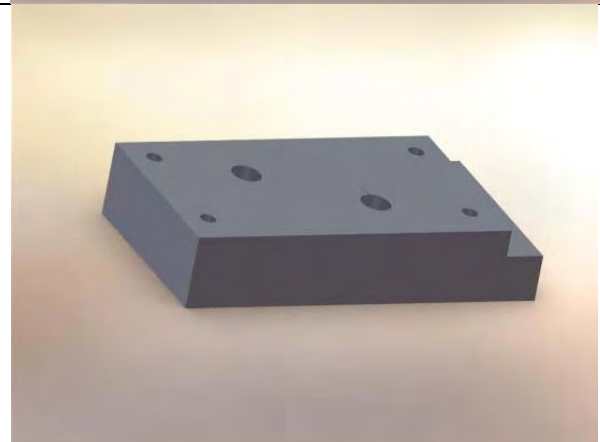



# NDT Supply.com, Inc.

7952 Nieman Road  
Lenexa, KS 66214-1560 USA



**Part No :** 99A57104337000  
**Purpose :**  
Ultrasonic Inspection Reference  
standard  
A300 NTM PART 4,  
57-13-11 Page 20

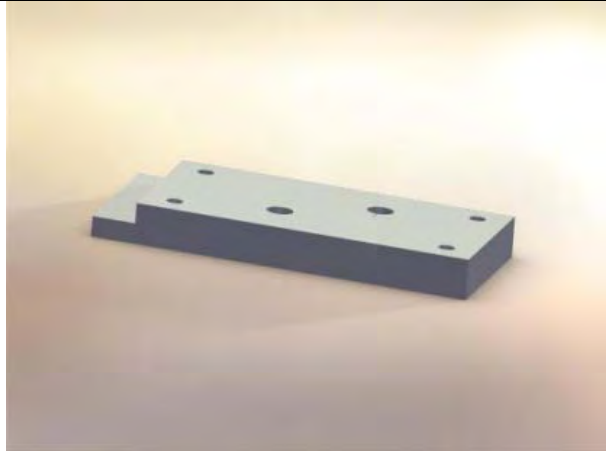

**Part No :** 99A57104338000  
**Purpose :**  
Ultrasonic Inspection Reference  
standard  
A300 NTM PART 4,  
57-11-20 Page 7

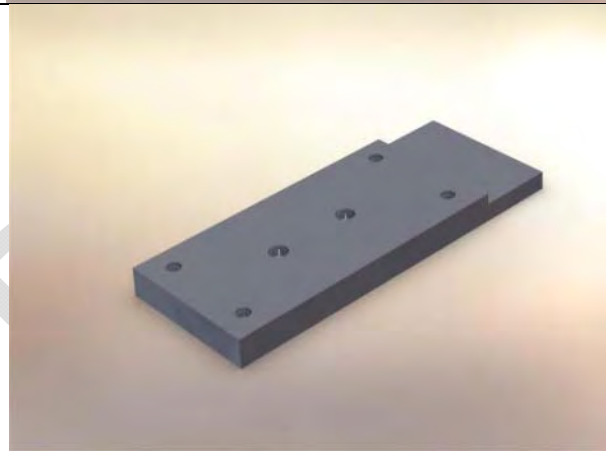

**Part No :** 99A57104340000  
**Purpose :**  
Ultrasonic Inspection Reference  
standard  
A300 NTM PART 4,  
57-11-20 Page 8



# NDT Supply.com, Inc.

7952 Nieman Road  
Lenexa, KS 66214-1560 USA

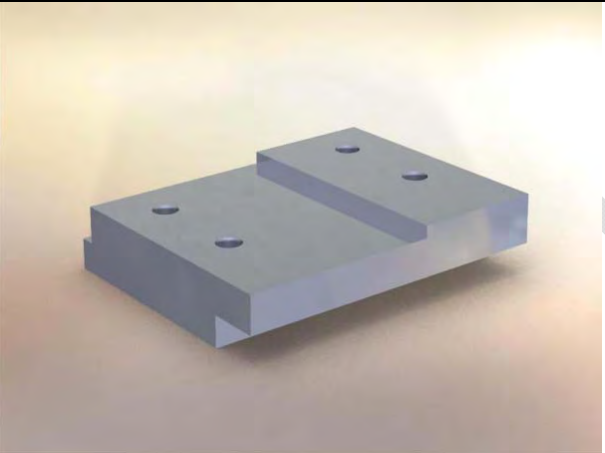
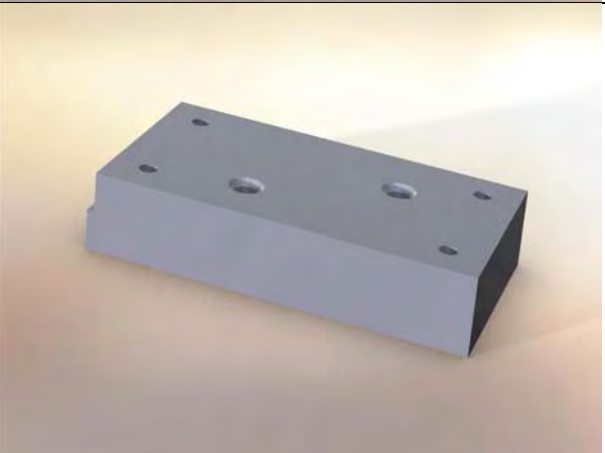
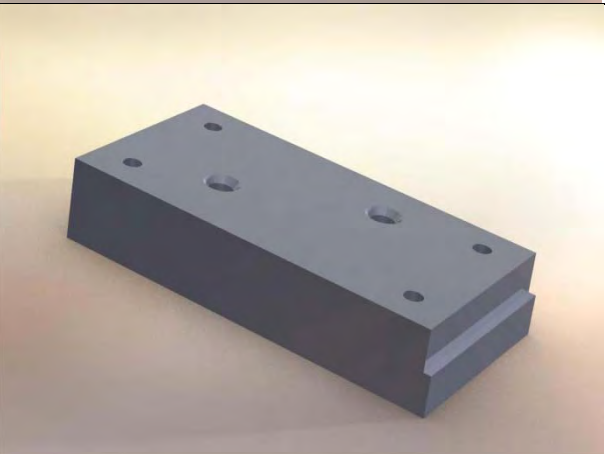

<p><b>Part No :</b> 99A57204360000 <b>Purpose :</b> Ultrasonic Inspection Reference standard A300 NTM PART 4, 57-11-27 Page 15</p>	
<p><b>Part No :</b> 99A57204375000 <b>Purpose :</b> Ultrasonic Inspection Reference standard A300 NTM PART 4, 57-11-28 Page 15, A310 NTM PART 4, 57-21-07 Page 406</p>	
<p><b>Part No :</b> 99A57204379000 <b>Purpose :</b> Ultrasonic Inspection Reference standard A300 NTM PART 4, 57-11-28 Page 14, A310 NTM PART 4, 57-21-07 Page 407</p>	

# NDT Supply.com, Inc.

7952 Nieman Road  
Lenexa, KS 66214-1560 USA



**Part No :** 99A57204387000  
**Usage Purpose :** Ultrasonic  
Inspection Reference standard  
A310 NTM PART 4, 57-25-02 Page  
405

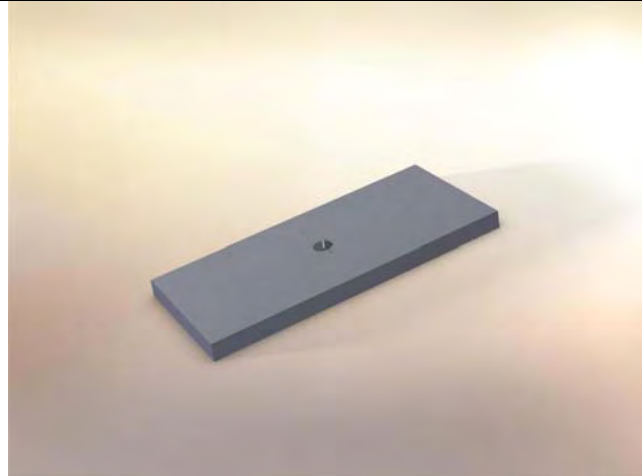

**Part No :** 99A57204390000  
**Purpose :**  
Ultrasonic Inspection Reference  
standard  
A300 NTM PART 4, 57-11-24 Page  
7

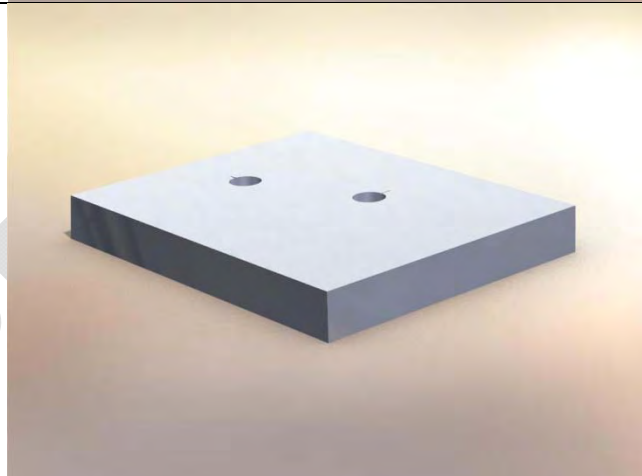

**Part No :** 99A57204390001  
**Purpose :**  
Ultrasonic Inspection Reference  
standard  
A300-600 NTM PART 4, 57-21-30  
Page 406

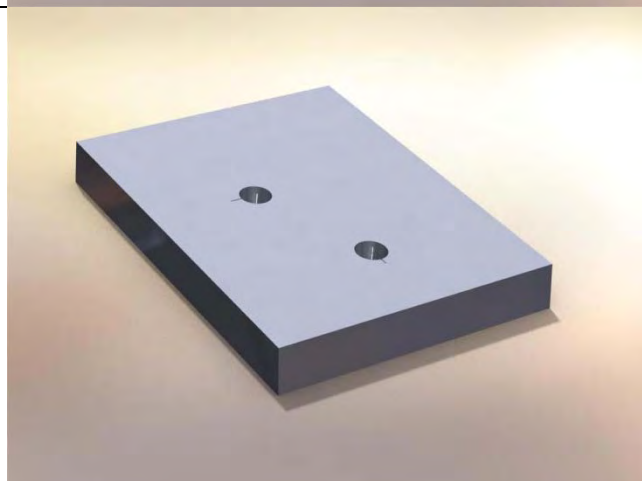



**Part No :** 99A57204391001  
**Purpose :**  
Eddy current Inspection Reference  
standard  
A310 NTM PART 6,  
57-25-26 Page 605

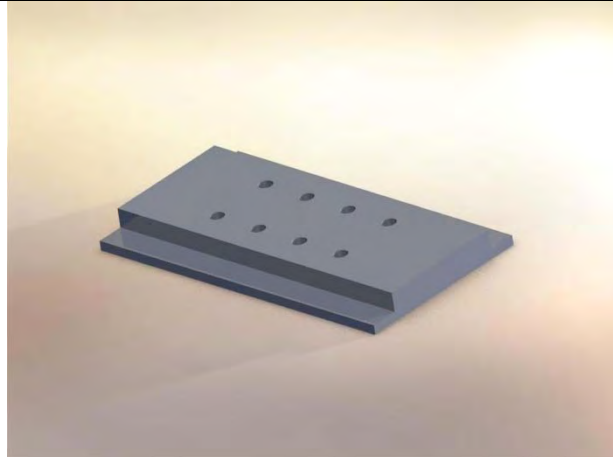

**Part No :** 99A57204394000  
**Purpose :**  
Ultrasonic Inspection Reference  
standard  
A310 NTM PART 4,  
57-25-65 Page 409

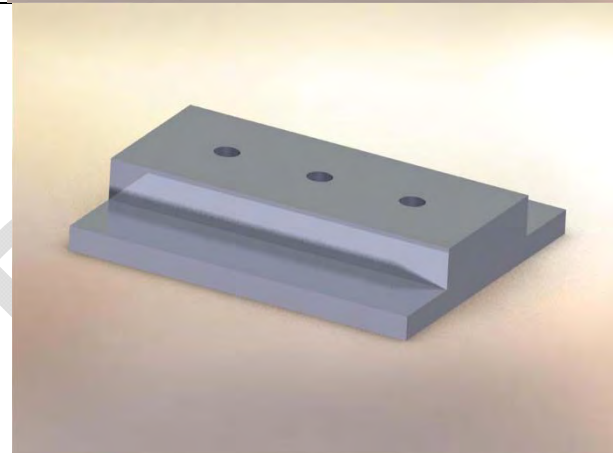

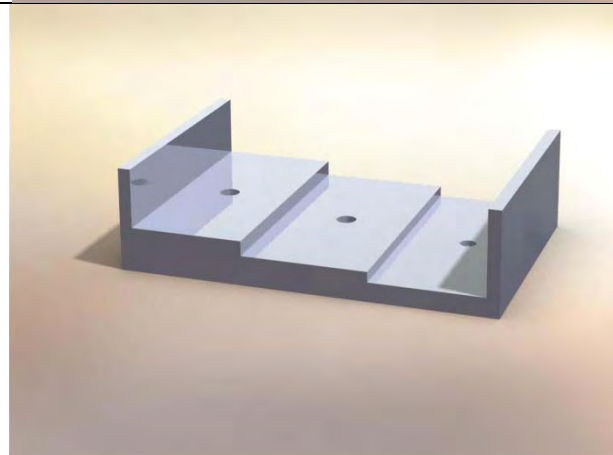

**Part No :** 99A57204401000  
**Purpose :**  
Ultrasonic Inspection Reference  
standard  
A310 NTM PART 4,  
57-25-49 Page 406



# NDT Supply.com, Inc.

7952 Nieman Road  
Lenexa, KS 66214-1560 USA

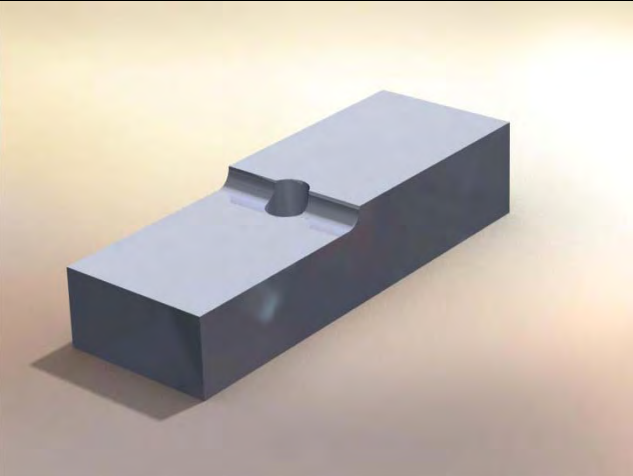

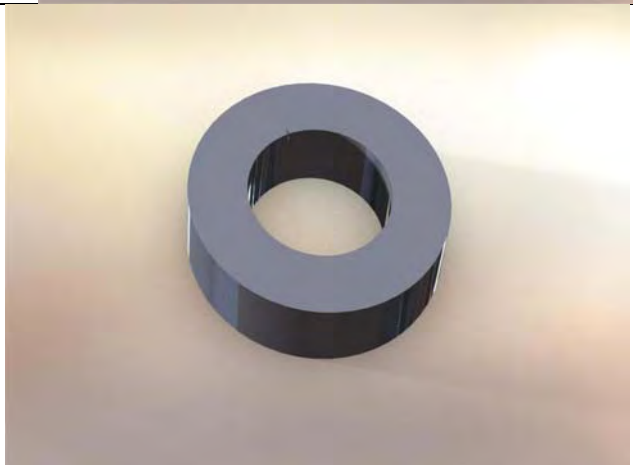
<p><b>Part No :</b> 99A57204410000 <b>Purpose :</b> Ultrasonic Inspection Reference standard A310 NTM PART 4, 57-21-24 Page 406</p>	 A 3D rendered image of a dark grey rectangular block. It has a notch cut into its top surface and a small circular hole on the top surface.
<p><b>Part No :</b> 99A57204425000 <b>Purpose :</b> Ultrasonic Inspection Reference standard A310 NTM PART 4, 57-21-25 Page 403</p>	 A 3D rendered image of a dark grey rectangular block with a small circular hole on its top surface.
<p><b>Part No :</b> 99A57703000000 <b>Purpose :</b> Ultrasonic Inspection Reference standard A310 NTM PART 4, 57-70-12 Page 404</p>	 A 3D rendered image of a dark grey ring or torus shape.



# NDT Supply.com, Inc.

7952 Nieman Road  
Lenexa, KS 66214-1560 USA



**Part No :** 99D51107295000  
**Purpose :** Ultrasonic Inspection  
Reference standard  
A310 NTM PART 1, 51-10-11  
Page 605

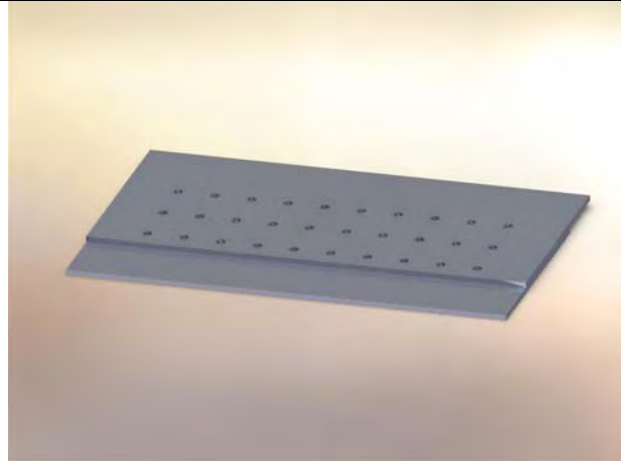

**Part No :** 99A57204362000  
**Purpose :**  
Ultrasonic Inspection standard  
A310 NTM PART 6, 57-25-46  
Page 603

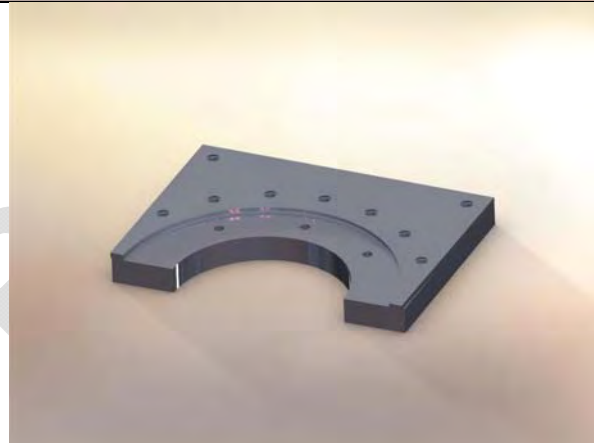

**Part No :** 99D57103009000.  
**Purpose :**  
Ultrasonic Inspection standard  
SSI NO.57-11-82 part 4

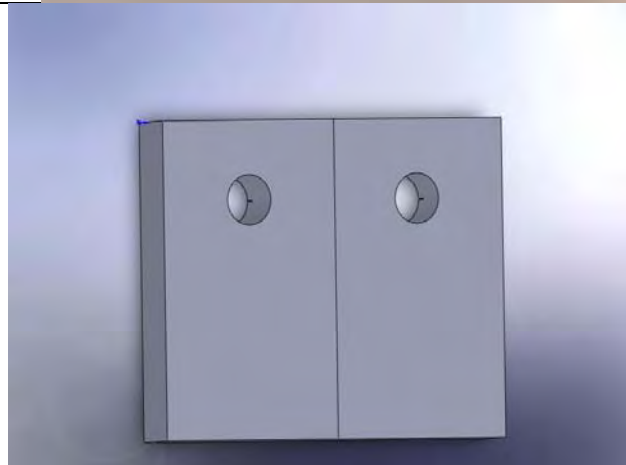

# NDT Supply.com, Inc.

7952 Nieman Road  
Lenexa, KS 66214-1560 USA

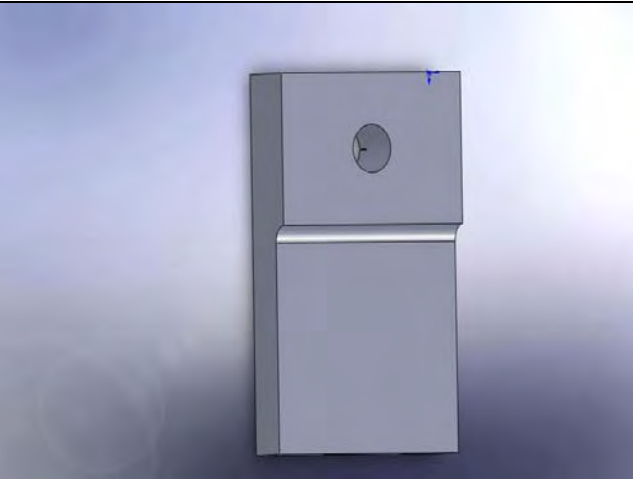
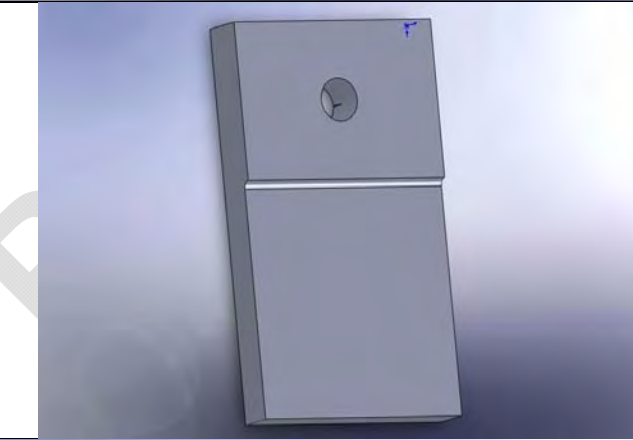
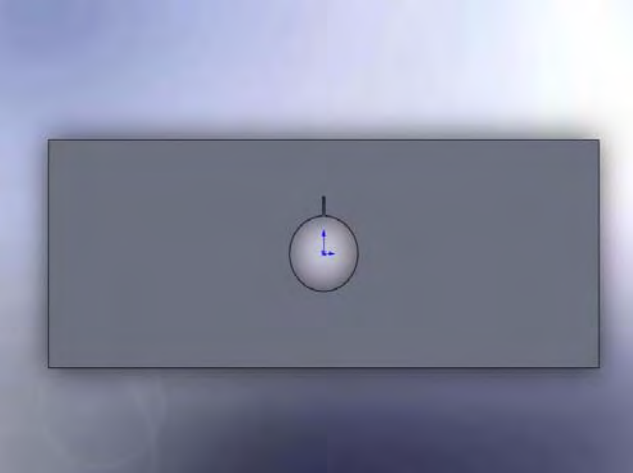

<p><b>Part No :</b> 99D57103008000 <b>Purpose :</b> Ultrasonic reference standard SSI NO.57-11-82 part 4</p>	
<p><b>Part No :</b> 99D5710301000 <b>Purpose :</b> Ultrasonic Reference standard SSI no. 57-11-82 ALI NO.57-11-82 PART 4</p>	
<p><b>Part No :</b> S809570184-7 <b>Purpose :</b> Ultrasonic Reference standard Fabrication</p>	

# NDT Supply.com, Inc.

7952 Nieman Road  
Lenexa, KS 66214-1560 USA



**Part No :** 99D5710301000  
**Purpose :**  
Ultrasonic Reference standard  
SSI no. 57-11-82  
ALI NO.57-11-82 PART 4

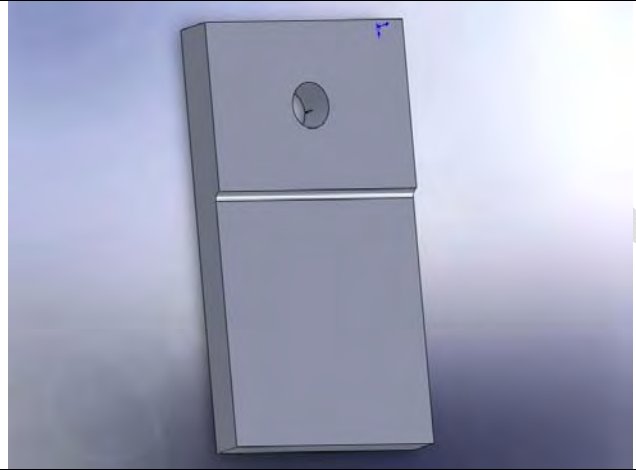

**Part No :** 98A52003003  
**Purpose :**  
Ultrasonic reference standard  
98A52003003

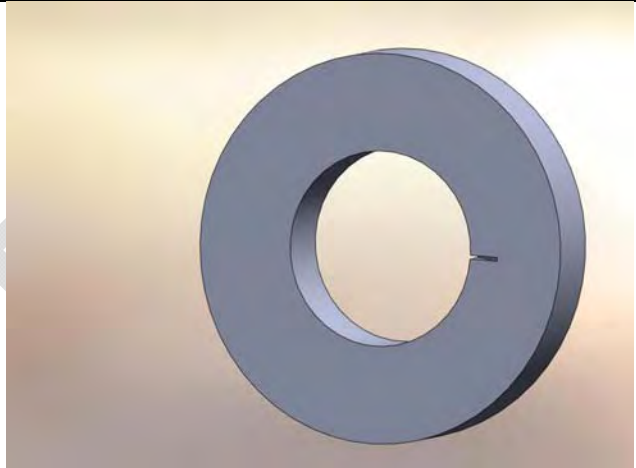

**Part No :** 99a57204406000  
**Purpose :**  
Ultrasonic reference standard  
99a57204406000

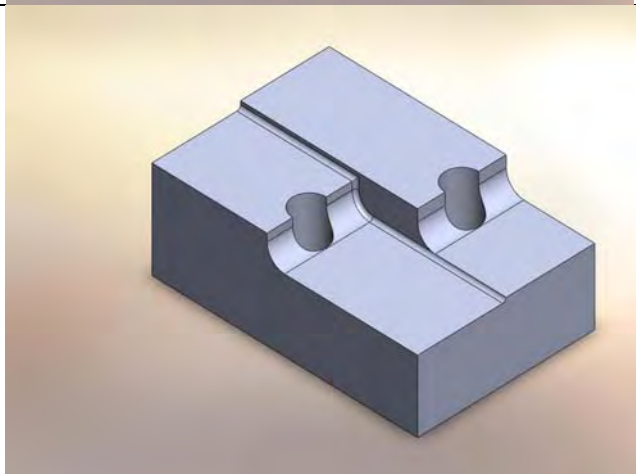

# NDT Supply.com, Inc.

7952 Nieman Road  
Lenexa, KS 66214-1560 USA



**Part No :** 99A57103038000  
**Purpose :**  
Ultrasonic reference  
A310 NTM PART 4 57-10-62  
PAGE 404

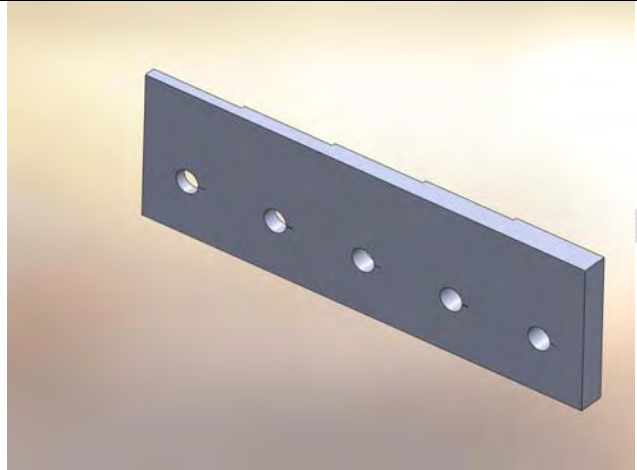

**Part No :** 99A53003002000  
**Purpose :**  
Ultrasonic reference  
A310 NTM PART 4 53-15-82  
PAGE 404

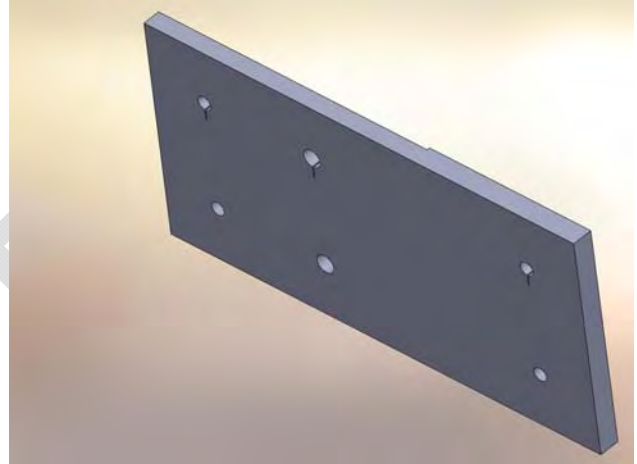

**Part No :** 99A57204400000  
**Purpose :**  
Ultrasonic reference  
A310 NTM PART 4 57-21-42  
PAGE 404

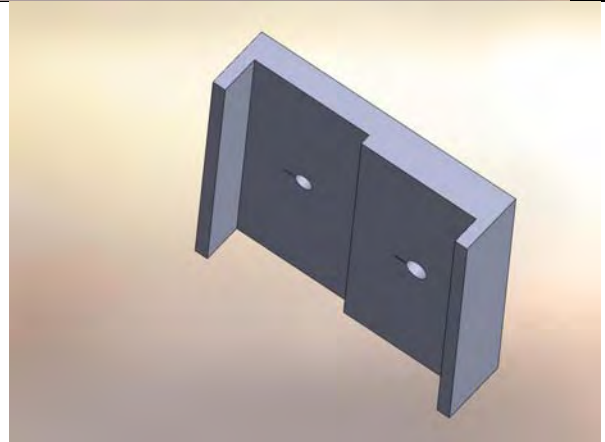

# NDT Supply.com, Inc.

7952 Nieman Road  
Lenexa, KS 66214-1560 USA

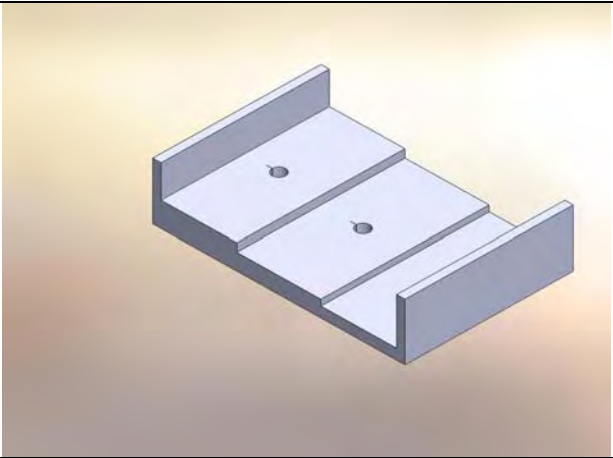
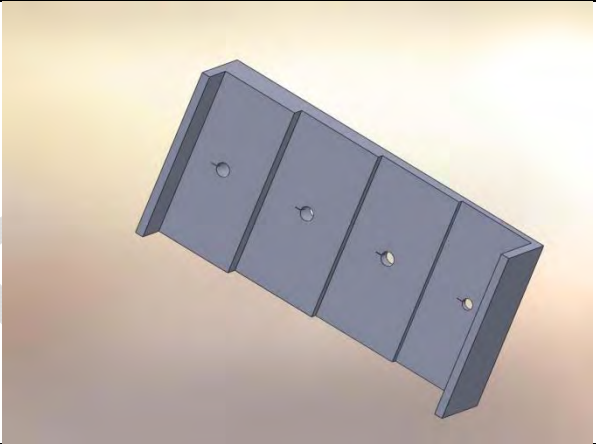
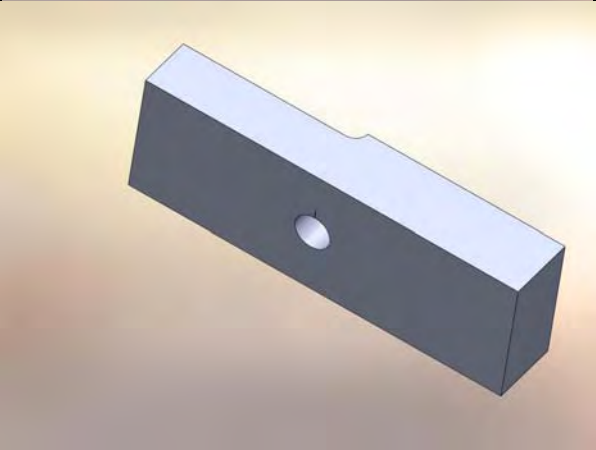

<p><b>Part No :</b> 99A57204401000 <b>Purpose :</b> Ultrasonic reference standard A310 NTM PART 4 57-25-49 PAGE 405</p>	
<p><b>Part No :</b> 99A57204402000 <b>Purpose :</b> Ultrasonic reference standard A310 NTM PART 4 57-21-87 PAGE 408</p>	
<p><b>Part No :</b> 99A57204410000 <b>Purpose :</b> Ultrasonic reference standard A310 NTM PART 4 57-21-22 PAGE 408</p>	



# NDT Supply.com, Inc.

7952 Nieman Road  
Lenexa, KS 66214-1560 USA

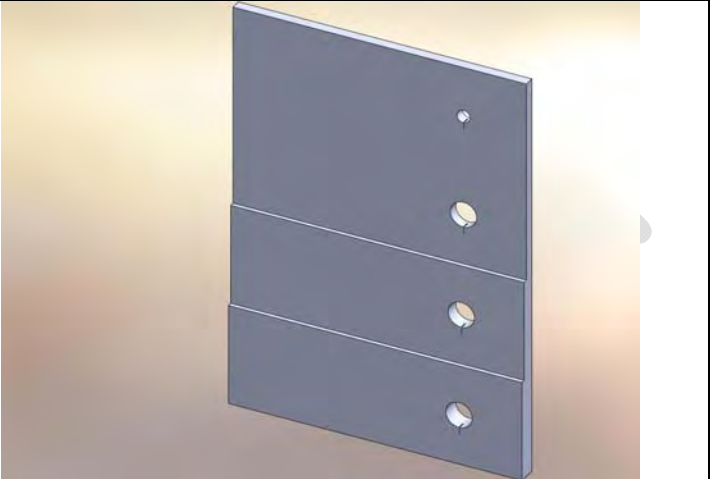
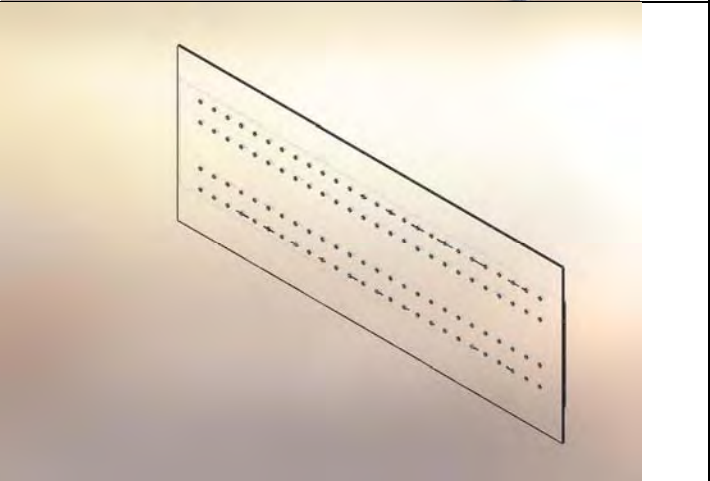
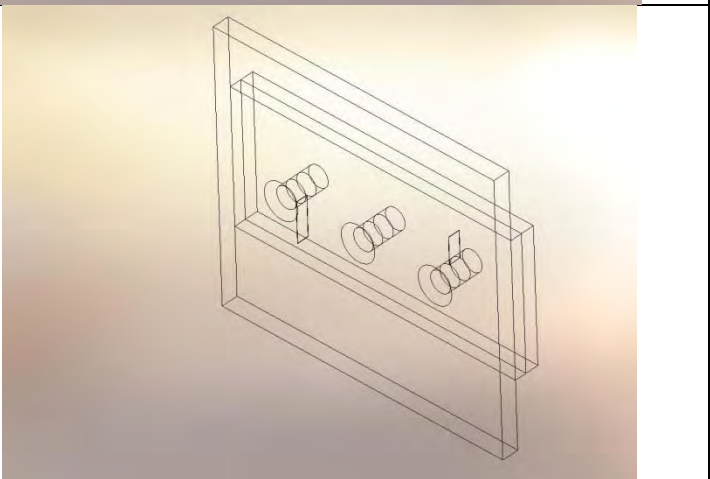

<p><b>Part No :</b> 99A57103031000 <b>Purpose :</b> Ultrasonic reference standard A310 NTM PART 4 57-10-22 PAGE 406</p>	 A 3D rendering of a dark grey rectangular plate with three horizontal bands. Each band has a circular hole in the center, for a total of three holes.
<p><b>Part No :</b> 99A53307249000 <b>Purpose :</b> Eddy Current reference standard A300 NTM PART 6 53-38-00 PAGE 5/6</p>	 A 3D rendering of a rectangular plate with a grid of small circular holes arranged in several rows.
<p><b>Part No :</b> 99A57204362000 <b>Purpose :</b> Eddy Current reference standard A310 NTM PART 6 57-25-44 PAGE 603</p>	 A 3D rendering of a rectangular frame containing three coiled wires or springs arranged horizontally.



**Part No :** 99A57004001320  
**Purpose :**  
Ultrasonic reference standard  
A310 NTM PART 4 57-21-85  
PAGE 404

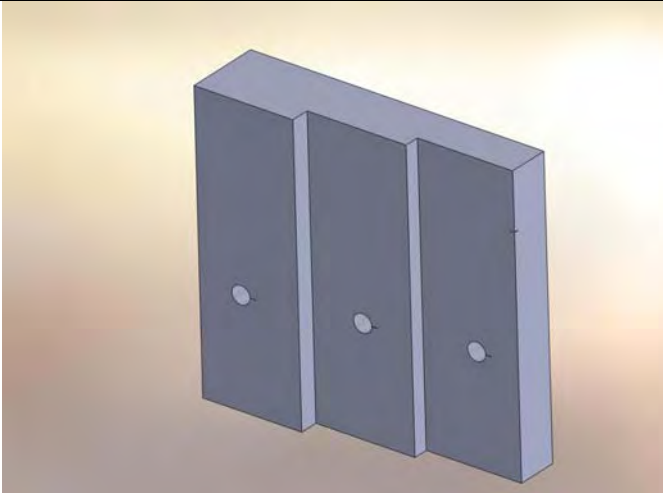

**Part No :** 99A57204394000  
**Purpose :**  
Ultrasonic reference standard  
A310 NTM PART 4 57-25-65  
PAGE 406



**Part No :** 98A54003097000  
**Purpose :**  
Ultrasonic reference standard  
A310 NTM PART 4 54-50-26  
PAGE 402

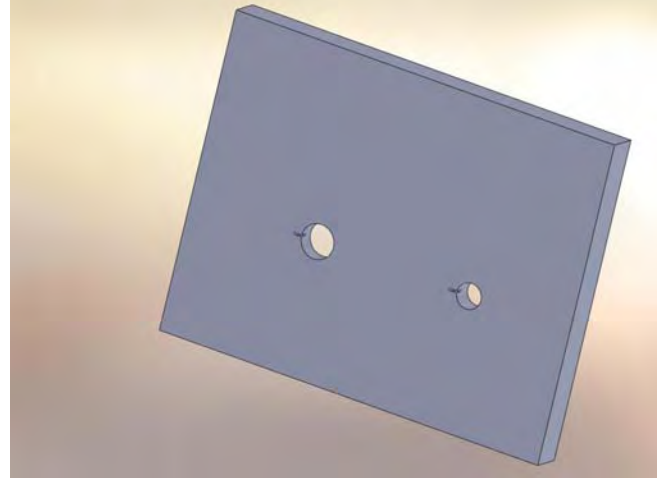

# NDT Supply.com, Inc.

7952 Nieman Road  
Lenexa, KS 66214-1560 USA

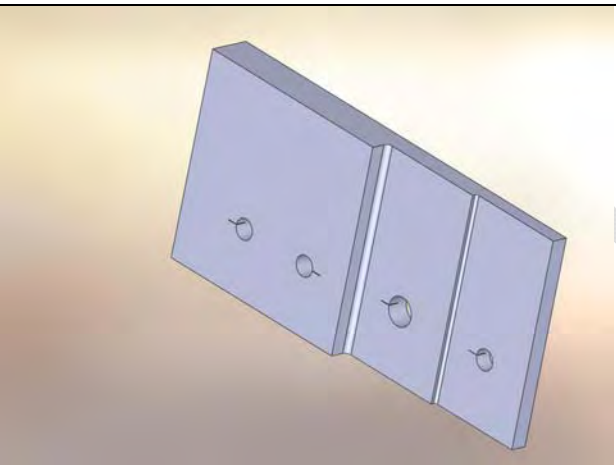
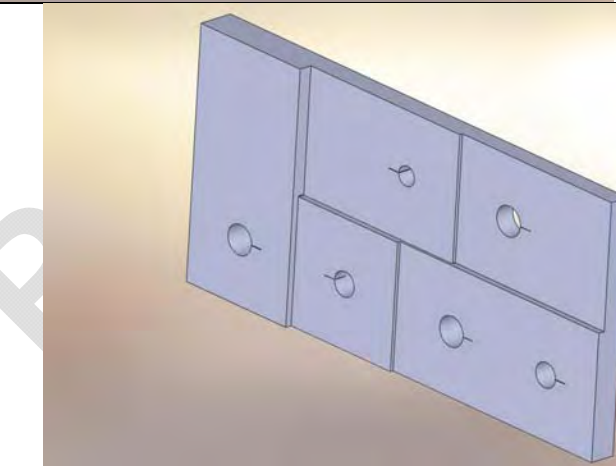
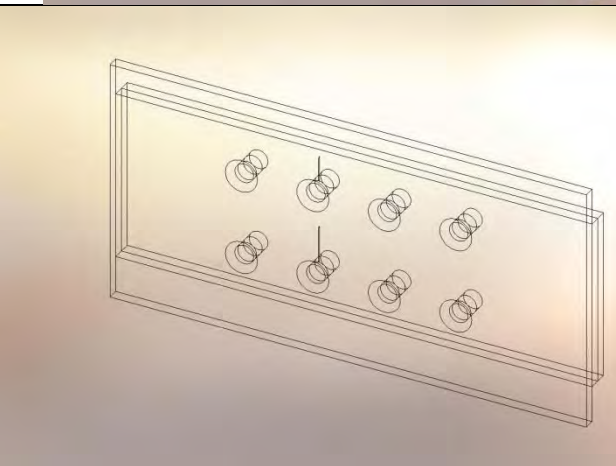

<p><b>Part No :</b> 99A57103003000 <b>Purpose :</b> Ultrasonic reference standard A310 NTM 57-10-24 PART 4 PAGE 404</p>	
<p><b>Part No :</b> 99A57103001000 <b>Purpose :</b> Ultrasonic reference standard A310 NTM 57-10-24 PART 4 PAGE 405</p>	
<p><b>Part No :</b> 99A57204391001 <b>Purpose :</b> Ultrasonic reference standard A310 NTM 57-25-26 PART 6 PAGE 605</p>	

# NDT Supply.com, Inc.

7952 Nieman Road  
Lenexa, KS 66214-1560 USA



**Part No :** 99A53307281000  
**Usage Purpose :**  
Eddy Current reference standard  
A300 NTM PART 6 53-30-10  
CONFIG-1 PAGE 13/14

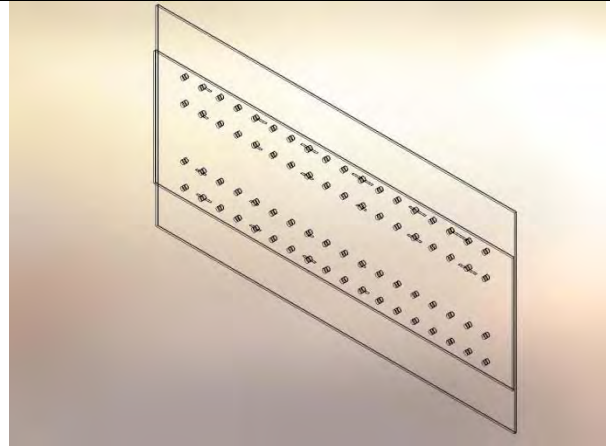

# NDT Supply.com, Inc.

7952 Nieman Road  
Lenexa, KS 66214-1560 USA



## McDonnell Douglas – Aircraft Ultrasonic and Eddy Current Standards

**Note:**

Contact us for a price and delivery quotation.

If you do not find the standard you need below, please send us a detail drawing for price and delivery.

<p><b>Part No :</b> A27288 <b>Purpose :</b> Eddy Current Inspection Reference standard SB DC9-27A235 R03</p>	 A 3D CAD rendering of a flat, rectangular metal block with a small horizontal line on its top surface. The block is shown from an isometric perspective against a light background.
<p><b>Part No :</b> SB09530186-9 <b>Purpose :</b> Eddy Current Inspection Reference standard SB DC9-53-186 R06</p>	 A 3D CAD rendering of a curved metal block with a semi-circular cutout on one side and several small circular holes along its top edge. The block is shown from an isometric perspective against a light background.



# NDT Supply.com, Inc.

7952 Nieman Road  
Lenexa, KS 66214-1560 USA



**Part No :** 7637987-1  
**Purpose :**  
Eddy Current Inspection  
Reference standard  
SB DC9-A53-142 309  
SHEET 11-12  
SB DC9-A53-142 R09

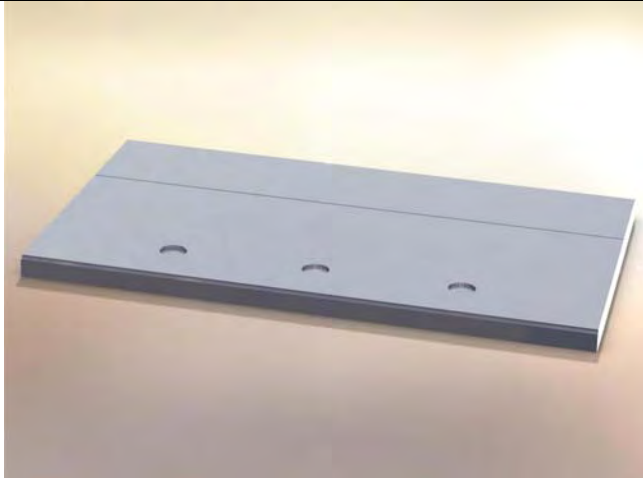

**Part No :** 7637987-9  
**Purpose :**  
Eddy Current Inspection  
Reference standard  
SB DC9-A53-142 R09

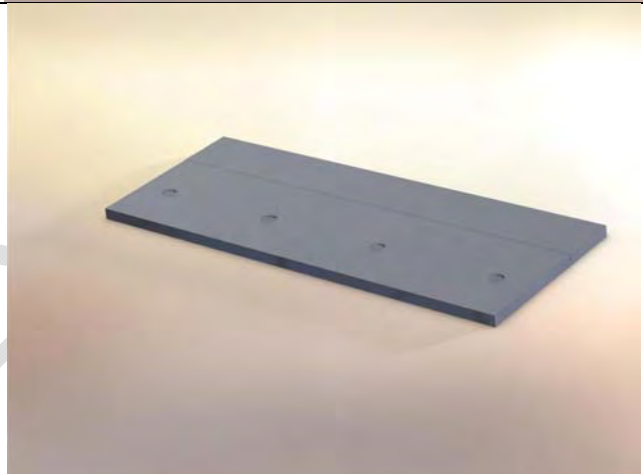

**Part No :** SB09530016-5  
**Purpose :**  
Eddy Current Inspection  
Reference standard  
SB MD-A27-320 R01

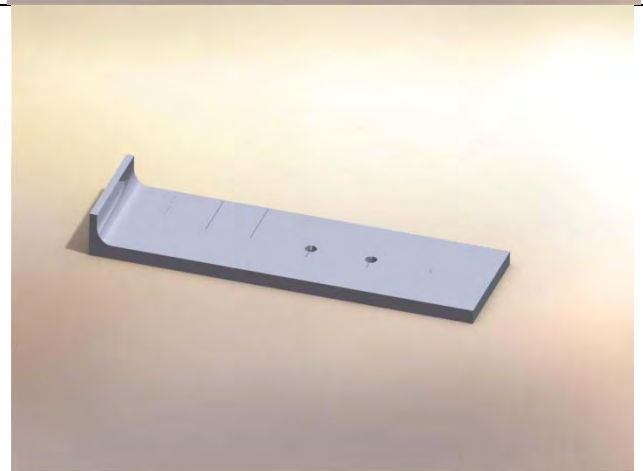

# NDT Supply.com, Inc.

7952 Nieman Road  
Lenexa, KS 66214-1560 USA



<p><b>Part No :</b> SB09270209-5 <b>Purpose :</b> Eddy Current Inspection Reference standard SB DC9-27-209 R07</p>	
<p><b>Part No :</b> 80RS7 <b>Purpose :</b> Ultrasonic Inspection Reference standard - MD-80</p>	
<p><b>Part No :</b> 80RS6 <b>Purpose :</b> Ultrasonic Inspection Reference standard - MD-80</p>	

# NDT Supply.com, Inc.

7952 Nieman Road  
Lenexa, KS 66214-1560 USA



<p><b>Part No :</b> 9RS17 <b>Purpose :</b> Ultrasonic Inspection Reference standard - MD-80</p>	 A 3D CAD model of a rectangular metal plate with two circular holes. A small blue arrow points to a specific location on the surface of the plate.
<p><b>Part No :</b> 80RS21 <b>Purpose :</b> Ultrasonic Inspection Reference standard - MD-80</p>	 A 3D CAD model of a rectangular metal block with a chamfered edge. A small blue arrow points to a specific location on the surface of the block.
<p><b>Part No :</b> 80RS22 <b>Purpose :</b> Ultrasonic Inspection Reference standard - MD-80</p>	 A 3D CAD model of a complex metal component with multiple surfaces, including a central section with four circular holes. A small blue arrow points to a specific location on the surface.

# NDT Supply.com, Inc.

7952 Nieman Road  
Lenexa, KS 66214-1560 USA

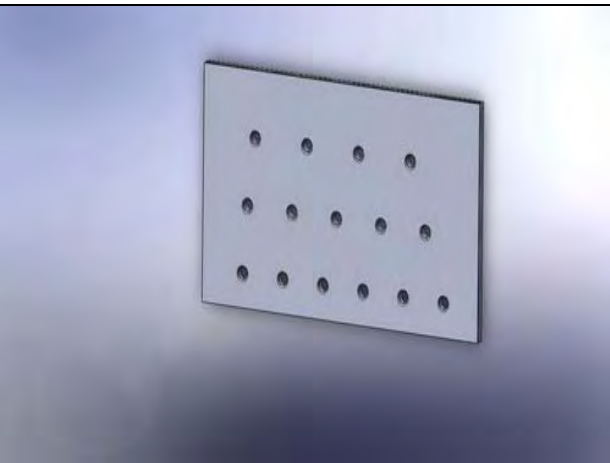
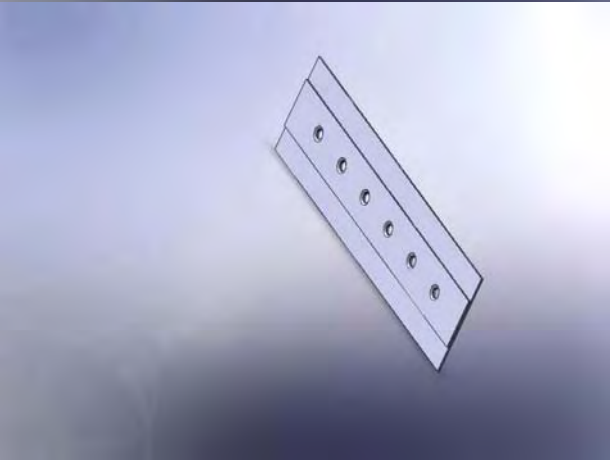
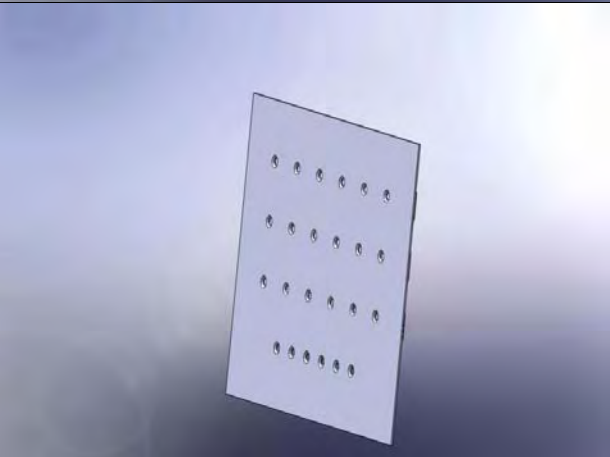

<p><b>Part No :</b> 9RS12 <b>Purpose :</b> Ultrasonic Inspection Reference standard - MD-80</p>	 A square metal plate with a grid of 15 small circular holes arranged in 3 rows and 5 columns.
<p><b>Part No :</b> 80RS19 <b>Purpose :</b> Ultrasonic Inspection Reference standard - MD-80</p>	 A rectangular metal plate with a single row of 5 circular holes.
<p><b>Part No :</b> 80RS18 <b>Purpose :</b> Ultrasonic Inspection Reference standard - MD-80</p>	 A rectangular metal plate with a grid of 20 small circular holes arranged in 4 rows and 5 columns.

# NDT Supply.com, Inc.

7952 Nieman Road  
Lenexa, KS 66214-1560 USA

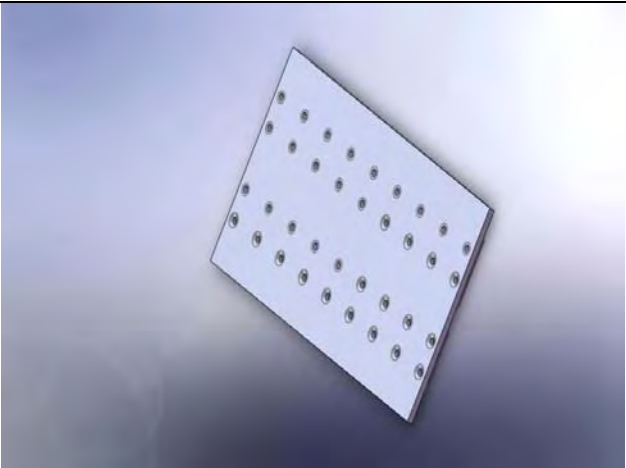
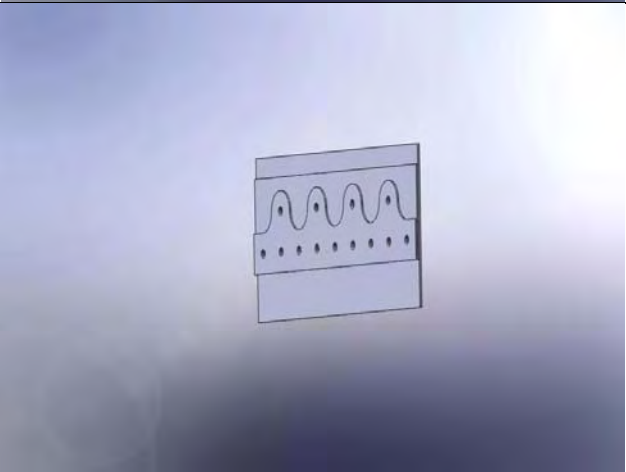

<p><b>Part No :</b> 80RS15 <b>Usage Purpose :</b> Ultrasonic Inspection Reference standard - MD-80</p>	 A photograph of a square metal plate with a grid of small circular holes. The plate is tilted and set against a dark blue background.
<p><b>Part No :</b> 80RS14 <b>Purpose :</b> Ultrasonic Inspection Reference standard - MD-80</p>	 A photograph of a rectangular metal plate with a grid of small circular holes and a wavy line pattern on its surface. The plate is tilted and set against a dark blue background.

NDT SUPPLY