

Chapter 10: Fundamentals of Processing

In the processing procedure, the invisible image produced in the film by exposure to x-rays, gamma rays, or light is made visible and permanent. Processing is carried out under subdued light of a color to which the film is relatively insensitive. The film is first immersed in a developer solution, which causes the areas exposed to radiation to become dark, the amount of darkening for a given degree of development depending on the degree of exposure. After development, and sometimes after a treatment designed to halt the developer reaction abruptly, the film passes into a fixing bath. The function of the fixer is to dissolve the darkened portions of the sensitive salt. The film is then washed to remove the fixing chemicals and solubilized salts, and finally is dried.

Processing techniques can be divided into two general classes--"Manual Processing" and "Automated Film Processing".

If the volume of work is small, or if time is of relatively little importance, radiographs may be processed by hand. The most common method of manual processing of industrial radiographs is known as the tank method. In this system, the processing solutions and wash water are contained in tanks deep enough for the film to be hung vertically. Thus, the processing solutions have free access to both sides of the film, and both emulsion surfaces are uniformly processed to the same degree. The all-important factor of temperature can be controlled by regulating the temperature of the water in which the processing tanks are immersed.

Where the volume of work is large or the holding time is important, automated processors are used. These reduce the darkroom manpower required, drastically shorten the interval between completion of the exposure and the availability of a dry radiograph ready for interpretation, and release the material being inspected much faster. Automated processors move films through the various solutions according to a predetermined schedule. Manual work is limited to putting the unprocessed film into the processor or into the film feeder, and removing the processed radiographs from the receiving bin.

General Considerations

Cleanliness

In handling x-ray films, cleanliness is a prime essential. The processing room, as well as the accessories and equipment, must be kept scrupulously clean and used only for the purposes for which they are intended. Any solutions that are spilled should be wiped up at once; otherwise, on evaporation, the chemicals may get into the air and later settle on film surfaces, causing spots. The thermometer and such accessories as film hangers should be thoroughly washed in clean water immediately after being used, so that processing solutions will not dry on them and possibly cause contamination of solutions or streaked radiographs when used again.

All tanks should be cleaned thoroughly before putting fresh solutions into them.

Mixing Processing Solutions

Processing solutions should be mixed according to the directions on the labels; the instructions as to water temperature and order of addition of chemicals should be followed carefully, as should the safe-handling precautions for chemicals given on labels or instruction sheets.

The necessary vessels or pails should be made of AISI Type 316 stainless steel with 2 to 3 percent molybdenum, or of enamelware, glass, plastic, hard rubber, or glazed earthenware. (Metals such as aluminum, galvanized iron, tin, copper, and zinc cause contamination and result in fog in the radiograph.)

Paddles or plunger-type agitators are practical for stirring solutions. They should be made of hard rubber, stainless steel, or some other material that does not absorb or react with processing solutions.

Separate paddles or agitators should be provided for the developer and fixer. If the paddles are washed thoroughly and hung up to dry immediately after use, the danger of contamination when they are employed again will be virtually nil. A motor-driven stirrer with a stainless steel propeller is a convenient aid in mixing solutions. In any event, the agitation used in mixing processing solutions should be vigorous and complete, but not violent.

Manual Processing

When tank processing is used, the routine is, first, to mount the exposed film on a hanger immediately after it is taken from the cassette or film holder, or removed from the factory-sealed envelope. (See Figure 71) Then the film can be conveniently immersed in the developer solution, stop bath, fixer solution, and wash water for the predetermined intervals, and it is held securely and kept taut throughout the course of the procedure.

At frequent intervals during processing, radiographic films must be agitated. Otherwise, the solution in contact with the emulsion becomes exhausted locally, affecting the rate and evenness of development or fixation.

Another precaution must be observed: The level of the developer solution must be kept constant by adding replenisher. This addition is necessary to replace the solution carried out of the developer tank by the films and hangers, and to keep the activity of the developer constant.

Special precautions are needed in the manual processing of industrial x-ray films in roll form. These are usually processed on the commercially available spiral stainless-steel reels. The space between the turns of film on such a reel is small, and loading must be done carefully lest the turns of film touch one another. The loaded reel should be placed in the developer so that the film is vertical—that is, the plane of the reel itself is horizontal. Agitation in the developer should not be so vigorous as to pull the edges of the film out of the spiral recesses in the reel. The reel must be carefully cleaned with a brush to remove any emulsion or dried chemicals that may collect within the film-retaining grooves.

Figure 71: Method of fastening film on a developing hanger. Bottom clips are fastened first, followed by top clips.

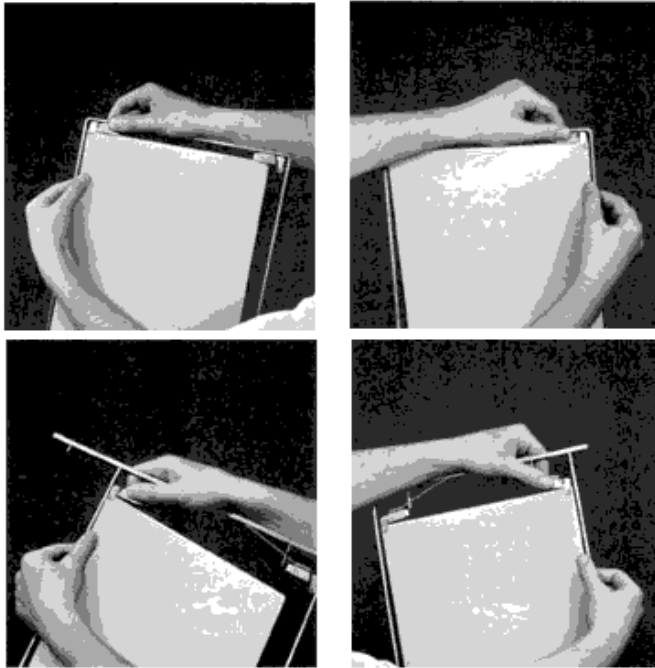

Cleanliness

Processing tanks should be scrubbed thoroughly and then well rinsed with fresh water before fresh solutions are put into them. In warm weather especially, it is advisable to sterilize the developer tanks occasionally. The growth of fungi can be minimized by filling the tank with an approximately 0.1 percent solution of sodium hypochlorite (Clorox, "101," Sunny Sol bleaches, etc, diluted 1:30), allowing it to stand several hours or overnight, and then thoroughly rinsing the tank. During this procedure, rooms should be well ventilated to avoid corrosion of metal equipment and instruments by the small concentrations of chlorine in the air. Another method is to use a solution of sodium pentachlorophenate, such as Dovicide G fungicide, at a strength of 1 part in 1,000 parts of water. This solution has the advantage that no volatile substance is present and it will not corrode metals. *In preparing the solution, avoid breathing the dust and getting it or the solution on your skin or clothing or into your eyes.*

Development

Developer Solutions

Prepared developers that are made ready for use by dissolving in water or by dilution with water provide a carefully compounded formula and uniformity of results. They are comparable in performance and effective life, but the liquid form offers greater convenience in preparation, which may be extremely important in a busy laboratory. Powder chemicals are, however, more economical to buy.

When the exposed film is placed in the developer, the solution penetrates the emulsion and begins to transform the exposed silver halide crystals to metallic silver. The longer the development is carried on, the more silver is formed and hence the denser the image becomes.

The rate of development is affected by the temperature of the solution--as the temperature rises, the rate of development increases. Thus, when the developer temperature is low, the reaction is

slow, and the development time recommended for the normal temperature would result in underdevelopment. When the temperature is high, the reaction is fast, and the same time would result in over development. Within certain limits, these changes in the rate of development can be compensated for by increasing or decreasing the time of development.

The time-temperature system of development should be used in all radiographic work. In this system, the developer temperature is always kept within a small range and the time of development is adjusted according to the temperature in such a way that the degree of development remains the same. If this procedure is not carefully observed, the effects of even the most accurate exposure technique will be nullified. Films cannot withstand the effects of errors resulting from guesswork in processing.

In particular, "sight development" should not be used; that is, the development time for a radiograph *should not* be decided by examining the film under safelight illumination at intervals during the course of development. It is extremely difficult to judge from the appearance of a developed but unfixed radiograph what its appearance will be in the dried state. Even though the final radiograph so processed is apparently satisfactory, there is no assurance that development was carried far enough to give the desired degree of film contrast. (See "Effect Of Development Time On Speed And Contrast".) Further, "sight development" can easily lead to a high level of fog caused by excessive exposure to safelights during development.

An advantage of standardized time-temperature processing is that by keeping the degree of development constant a definite check on exposure time can always be made. This precludes many errors that might otherwise occur in the production of radiographs. When the processing factors are known to be correct but the radiographs lack density, underexposure can be assumed; when the radiographic image is too dense, overexposure is indicated. The first condition can be corrected by increasing the exposure time; and the second, by decreasing it. The methods for calculating the required changes in exposure are given in Arithmetic of Exposure.

Control of Temperature and Time

Because the temperature of the processing solutions has a decided influence on their activity, careful control of this factor is very important. It should be a rule that the developer be stirred and the temperature be checked immediately before films are immersed in it so that they can be left in the solution for the proper length of time.

Ideally, the temperature of the developer solution should be 68°F (20°C). A temperature below 60°F (16°C) retards the action of the chemical and is likely to result in underdevelopment, whereas an excessively high temperature not only may destroy the photographic quality by producing fog but also may soften the emulsion to the extent that it separates from the base.

When, during extended periods, the tap water will not cool the solutions to recommended temperatures, the most effective procedure is to use mechanical refrigeration. Conversely, heating may be required in cold climates. Under no circumstances should ice be placed directly in processing solutions to reduce their temperature because, on melting, the water will dilute them and possibly cause contamination.

Because of the direct relation between temperature and time, both are of equal importance in a standardized processing procedure. So, after the temperature of the developer solution has been determined, films should be left in the solution for the exact time that is required. Guesswork should not be tolerated. Instead, when the films are placed in the solution, a timer should be set so that an alarm will sound at the end of the time.

Agitation

It is essential to secure uniformity of development over the whole area of the film. This is achieved by agitating the film during the course of development.

If a radiographic film is placed in a developer solution and allowed to develop without any movement, there is a tendency for each area of the film to affect the development of the areas immediately below it. This is because the reaction products of development have a higher specific gravity than the developer and, as these products diffuse out of the emulsion layer, they flow downward over the film surface and retard the development of the areas over which they pass. The greater the film density from which the reaction products flow, the greater is the restraining action on the development of the lower portions of the film. Thus, large lateral variations in film density will cause uneven development in the areas below, and this may show up in the form of streaks. Figure 72 illustrates the phenomena that occur when a film having small areas whose densities are widely different from their surroundings is developed without agitation of film or developer.

Figure 72: An example of streaking that can result when a film has been allowed to remain in the solution without agitation during the entire development period.

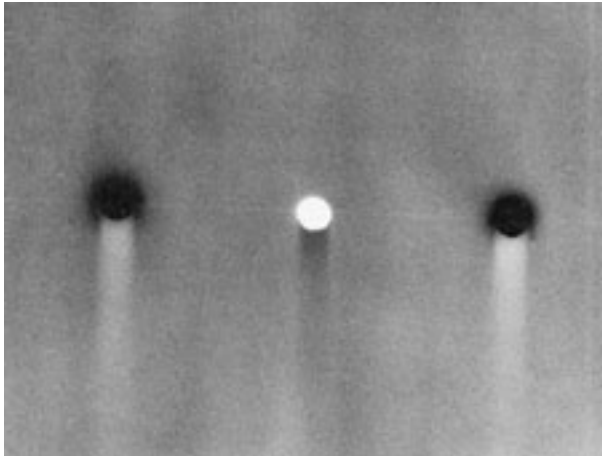

Agitation of the film during development brings fresh developer to the surface of the film and prevents uneven development. In small installations, where few films are processed, agitation is most easily done by hand. Immediately after the hangers are lowered smoothly and carefully into the developer, the upper bars of the hangers should be tapped sharply two or three times on the upper edge of the tank to dislodge any bubbles clinging to the emulsion. Thereafter, films should be agitated periodically throughout the development.

Acceptable agitation results if the films are shaken vertically and horizontally and moved from side to side in the tank for a few seconds every minute during the course of the development. More satisfactory renewal of developer at the surface of the film is obtained by lifting the film clear of the developer, allowing it to drain from one corner for 2 or 3 seconds, reinserting it into the developer, and then repeating the procedure, with drainage from the other lower corner. The whole cycle should be repeated once a minute during the development time.

Another form of agitation suitable for manual processing of sheet films is known as "gaseous burst agitation." It is reasonably economical to install and operate and, because it is automatic, does not require the full-time attention of the processing room operator. Nitrogen, because of its inert chemical nature and low cost, is the best gas to use.

Gaseous burst agitation consists of releasing bursts of gas at controlled intervals through many small holes in a distributor at the bottom of the processing tank. When first released, the bursts impart a sharp displacement pulse, or piston action, to the entire volume of the solution. As the

bubbles make their way to the surface, they provide localized agitation around each small bubble. The great number of bubbles, and the random character of their paths to the surface, provide effective agitation at the surfaces of films hanging in the solution (See Figure 73)

Figure 73: Distribution manifold for gaseous burst agitation.



If the gas were released continuously, rather than in bursts, constant flow patterns would be set up from the bottom to the top of the tank and cause uneven development. These flow patterns are not encountered, however, when the gas is introduced in short bursts, with an interval between bursts to allow the solution to settle down.

Note that the standard sizes of x-ray developing tanks will probably not be suitable for gaseous burst agitation. Not only does the distributor at the bottom of the tank occupy some space, but also the tank must extend considerably above the surface of the still developer to contain the froth that results when a burst of bubbles reaches the surface. It is therefore probable that special tanks will have to be provided if the system is adopted.

Agitation of the developer by means of stirrers or circulating pumps should be discouraged. In any tank containing loaded film hangers, it is almost impossible to prevent the uniform flow of developer along certain paths. Such steady flow conditions may sometimes cause more uneven development than no agitation at all.

Activity of Developer Solutions

As a developer is used, its developing power decreases, partly because of the consumption of the developing agent in changing the exposed silver bromide to metallic silver, and also because of the restraining effect of the accumulated reaction products of the development. The extent of this decrease in activity will depend on the number of films processed and their average density. Even when the developer is not used, the activity may decrease slowly because of aerial oxidation of the developing agent.

Some compensation must be made for the decrease in developing power if uniform radiographic results are to be obtained over a period of time. The best way to do this is to use the replenisher system, in which the activity of the solution is not allowed to diminish but rather is maintained by suitable chemical replenishment.

In reference to the *replenisher method* or *replenishment*, the following should be understood. As used here, replenishment means the addition of a stronger-than-original solution, to revive or restore the developer to its approximate original strength. Thus, the replenisher performs the double function of maintaining both the liquid level in the developing tank and the activity of the solution. Merely adding original-strength developer would not produce the desired regenerating effect; development time would have to be progressively increased to achieve a constant degree of development.

The quantity of replenisher required to maintain the properties of the developer will depend on the average density of the radiographs processed. It is obvious that if 90 percent of the silver in the emulsion is developed, giving a dense image over the entire film, more developing agent will be consumed. Therefore, the developer will be exhausted to a greater degree than if the film were developed to a low density. The quantity of replenisher required, therefore, depends on the type of subject radiographed. In the processing of industrial radiographs that have a relatively large proportion of dense background, some of the original developer must be discarded each time replenisher is added. The exact quantity of replenisher can be determined only by trial and by frequent testing of the developer.

The replenisher should be added at frequent intervals and in sufficient quantity to maintain the activity reasonably constant for the types of radiographs processed. It is obvious that if replenisher is added only occasionally, there will be a large increase in density of the film after replenishing. By replenishing frequently, these density increases after replenishing are kept at a minimum. The quantity of the replenisher added each time preferably should not exceed 2 or 3 percent of the total volume of the developer in the tank.

It is not practical to continue replenishment indefinitely, and the solution should be discarded when the replenisher used equals two to three times the original quantity of the developer. In any case, the solution should be discarded after three months because of aerial oxidation and the buildup of gelatin, sludge, and solid impurities.

Arresting Development

After development is complete, developer remaining in the emulsion must be deactivated by an acid stop bath or, if this is not feasible, by prolonged rinsing in clean running water.

If this step is omitted, development continues for the first minute or so of fixation and, unless the film is agitated almost continuously during this period, uneven development will occur, resulting in streakiness.

In addition, if films are transferred to the fixer solution without the use of an acid stop bath or thorough rinsing, the alkali from the developer solution retained by the gelatin neutralizes some of the acid in the fixer solution. After a certain quantity of acid has been neutralized, the chemical balance of the fixer solution is upset and its usefulness is greatly impaired--the hardening action is destroyed and stains are likely to be produced in the radiographs. Removal of as much of the developer solution as possible before fixation prolongs the life of the fixer solution and assures the routine production of radiographs of better quality.

Stop Bath

A stop bath consisting of 16 fluidounces of 28 percent acetic acid per gallon of bath (125 mL per litre) may be used. If the stop bath is made from glacial acetic acid, the proportions should be 4½ fluidounces of glacial acetic acid per gallon of bath, or 35 mL per litre.

Warning



Glacial acetic acid should be handled only under adequate ventilation, and great care should be taken to avoid injury to the skin or damage to clothing. Always add the glacial acetic acid to the water slowly, stirring constantly, and never water to acid; otherwise, the solution may boil and spatter acid on hands and face, causing severe burns.

When development is complete, the films are removed from the developer, allowed to drain 1 or 2 seconds (not back into the developer tank), and immersed in the stop bath. The developer draining from the films should be kept out of the stop bath. Instead of draining, a few seconds' rinse in fresh running water may be used prior to inserting the films in the stop bath. This will materially prolong the life of the bath.

Films should be immersed in the stop bath for 30 to 60 seconds (ideally, at 65 to 70°F or 18 to 21°C) with moderate agitation and then transferred to the fixing bath. Five gallons of stop bath will treat about 100 14 x 17-inch films, or equivalent. If a developer containing sodium carbonate is used, the stop bath temperature must be maintained between (65 and 70°F or 18 to 21°C); otherwise, blisters containing carbon dioxide may be formed in the emulsion by action of the stop bath.

Rinsing

If a stop bath cannot be used, a rinse in *running* water for at least 2 minutes should be used. It is important that the water be running and that it be free of silver or fixer chemicals. The tank that is used for the final washing after fixation should not be used for this rinse.

If the flow of water in the rinse tanks is only moderate, it is desirable to agitate the films carefully, especially when they are first immersed. Otherwise, development will be uneven, and there will be streaks in areas that received a uniform exposure.

Fixing

The purpose of fixing is to remove all of the undeveloped silver salt of the emulsion, leaving the developed silver as a permanent image. The fixer has another important function—hardening the gelatin so that the film will withstand subsequent drying with warm air. The interval between placing the film in the fixer solution and the disappearance of the original diffuse yellow milkiness is known as the *clearing time*. It is during this time that the fixer is dissolving the undeveloped silver halide. However, additional time is required for the dissolved silver salt to diffuse out of the emulsion and for the gelatin to be hardened adequately. Thus, the total *fixing time* should be appreciably greater than the clearing time. The fixing time in a relatively fresh fixing bath should, in general, not exceed 15 minutes; otherwise, some loss of low densities may occur. The films should be agitated vigorously when first placed in the fixer and at least every 2 minutes thereafter during the course of fixation to assure uniform action of the chemicals.

During use, the fixer solution accumulates soluble silver salts which gradually inhibit its ability to dissolve the unexposed silver halide from the emulsion. In addition, the fixer solution becomes diluted by rinse water or stop bath carried over by the film. As a result, the rate of fixing decreases, and the hardening action is impaired. The dilution can be reduced by thorough draining of films before immersion in the fixer and, if desired, the fixing ability can be restored by replenishment of the fixer solution.

The usefulness of a fixer solution is ended when it has lost its acidity or when clearing requires an unusually long interval. The use of an exhausted solution should always be avoided because abnormal swelling of the emulsion often results from deficient hardening and drying is unduly prolonged; at high temperatures reticulation or sloughing away of the emulsion may take place. In addition, neutralization of the acid in the fixer solution frequently causes colored stains to appear on the processed radiographs.

Washing

X-ray films should be washed in running water so circulated that the entire emulsion area receives frequent changes. For a proper washing, the bar of the hanger and the top clips should always be covered completely by the running water, as illustrated in Figure 74.

Figure 74: Water should flow over the tops of the hangers in the washing compartment. This avoids streaking due to contamination of the developer when hangers are used over again.



Efficient washing of the film depends both on a sufficient flow of water to carry the fixer away rapidly and on adequate time to allow the fixer to diffuse from the film. Washing time at 60 to 80° F (15.5 to 26.5° C) with a rate of water flow of four renewals per hour is 30 minutes.

The films should be placed in the wash tank near the outlet end. Thus, the films most heavily laden with fixer are first washed in water that is somewhat contaminated with fixer from the films previously put in the wash tank. As more films are put in the wash tank, those already partially washed are moved toward the inlet, so that the final part of the washing of each film is done in fresh, uncontaminated water.

The tank should be large enough to wash films as rapidly as they can be passed through the other solutions. Any excess capacity is wasteful of water or, with the same flow as in a smaller tank, diminishes the effectiveness with which fixer is removed from the film emulsion. Insufficient capacity, on the other hand, encourages insufficient washing, leading to later discoloration or fading of the image.

The "cascade method" of washing is the most economical of water and results in better washing in the same length of time. In this method, the washing compartment is divided into two sections. The films are taken from the fixer solution and first placed in Section A. (See Figure 75) After they have been partially washed, they are moved to Section B, leaving Section A ready to receive more films from the fixer. Thus, films heavily laden with fixer are washed in somewhat contaminated water, and washing of the partially washed films is completed in fresh water.

Figure 75: Schematic diagram of a cascade washing unit.

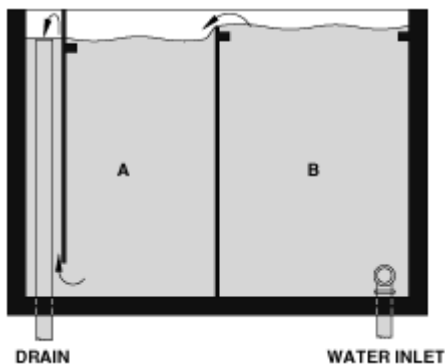

Washing efficiency decreases rapidly as temperature decreases and is very low at temperatures below 60°F (15.5°C). On the other hand, in warm weather, it is especially important to remove films from the tank as soon as washing is completed, because gelatin has a natural tendency to

soften considerably with prolonged washing in water above 68°F (20°C). Therefore, if possible the temperature of the wash water should be maintained between 65 and 70°F or 18 and 21°C).

Formation of a cloud of minute bubbles on the surfaces of the film in the wash tank sometimes occurs. These bubbles interfere with washing the areas of emulsion beneath them, and can subsequently cause a discoloration or a mottled appearance of the radiograph. When this trouble is encountered, the films should be removed from the wash water and the emulsion surfaces wiped with a soft cellulose sponge at least twice during the washing period to remove the bubbles. Vigorous tapping of the top bar of the hanger against the top of the tank rarely is sufficient to remove the bubbles.

Prevention of Water Spots

When films are removed from the wash tanks, small drops of water cling to the surfaces of the emulsions. If the films are dried rapidly, the areas under the drops dry more slowly than the surrounding areas. This uneven drying causes distortion of the gelatin, changing the density of the silver image, and results in spots that are frequently visible and troublesome in the finished radiograph.

Such "water spots" can be largely prevented by immersing the washed films for 1 or 2 minutes in a wetting agent, then allowing the bulk of the water to drain off before the films are placed in the drying cabinet. This solution causes the surplus water to drain off the film more evenly, reducing the number of clinging drops. This reduces the drying time and lessens the number of water spots occurring on the finished radiographs.

Drying

Convenient racks are available commercially for holding hangers during drying when only a small number of films are processed daily. When the racks are placed high on the wall, the films can be suspended by inserting the crossbars of the processing hangers in the holes provided. This obviates the danger of striking the radiographs while they are wet, or spattering water on the drying surfaces, which would cause spots on them. Radiographs dry best in warm, dry air that is changing constantly.

When a considerable number of films are to be processed, suitable driers with built-in fans, filters, and heaters or desiccants are commercially available.

Marks in Radiographs

Defects, spots, and marks of many kinds may occur if the preceding general rules for manual processing are not carefully followed. Perhaps the most common processing defect is streakiness and mottle in areas that receive a uniform exposure. This unevenness may be a result of:

- Failure to agitate the films sufficiently during development or the presence of too many hangers in the tank, resulting in inadequate space between neighboring films.
- Insufficient rinsing in water or failure to agitate the films sufficiently before fixation.
- The use of an exhausted stop bath or failure to agitate the film properly in the stop bath.
- In the absence of satisfactory rinsing--insufficient agitation of the films on first immersing them in the fixing bath.

Other characteristic marks are dark spots caused by the spattering of developer solution, static electric discharges, and finger marks; and dark streaks occurring when the developer-saturated film is inspected for a prolonged time before a safelight lamp. If possible, films should never be examined at length until they are dry.

A further trouble is fog - that is, development of silver halide grains other than those affected by radiation during exposure. It is a great source of annoyance and may be caused by accidental exposure to light, x-rays, or radioactive substances; contaminated developer solution;

development at too high a temperature; or storing films under improper storage conditions (see "Storage Of Exposed And Processed Film") or beyond the expiration dates stamped on the cartons.

Accidental exposure of the film to x-radiation or gamma radiation is a common occurrence because of insufficient protection from high-voltage tubes or stored radioisotopes; films have been fogged through 1/8 inch of lead in rooms 50 feet or more away from an x-ray machine.

Automated Film Processing

Automated processing requires a processor (See Figure 76), specially formulated chemicals and compatible film, all three of which must work together to produce high-quality radiographs. This section describes how these three components work together.

Figure 76: An automated processor has three main sections: a film-feeding section; a film-processing section (developer, fixer, and wash); and a film-drying section.

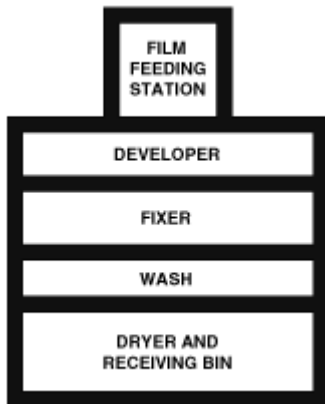

Processing Control

The essence of automated processing is control, both chemical and mechanical. In order to develop, fix, wash, and dry a radiograph in the short time available in an automated processor, specifically formulated chemicals are used. The processor maintains the chemical solutions at the proper temperatures, agitates and replenishes the solutions automatically, and transports the films mechanically at a carefully controlled speed throughout the processing cycle. Film characteristics must be compatible with processing conditions, shortened processing times and the mechanical transport system. From the time a film is fed into the processor until the dry radiograph is delivered, chemicals, mechanics, and film must work together.

Automated Processor Systems

Automated processors incorporate a number of systems which transport, process, and dry the film and replenish and recirculate the processing solutions. A knowledge of these systems and how they work together will help in understanding and using automated processing equipment.

Transport System

The function of the transport system (See Figure 77) is to move film through the developer and fixer solutions and through the washing and drying sections, holding the film in each stage of the processing cycle for exactly the right length of time, and finally to deliver the ready-to-read radiograph.

Figure 77: The roller transport system is the backbone of an automated processor. The arrangement and number of its components vary, but the basic plan is virtually the same.

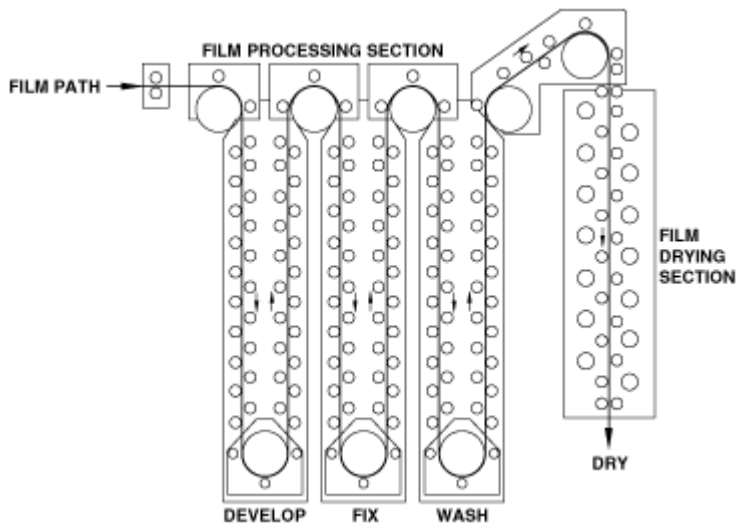

In most automated processors now in use, the film is transported by a system of rollers driven by a constant speed motor. The rollers are arranged in a number of assemblies--entrance roller assembly, racks, turnarounds (which reverse direction of film travel within a tank), crossovers (which transfer films from one tank to another), and a squeegee assembly (which removes surface water after the washing cycle). The number and specific design of the assemblies may vary from one model of processor to another, but the basic design is the same.

It is important to realize that the film travels at a constant speed in a processor, but that the speed in one model may differ from that in another. Processing cycles--the time interval from the insertion of an unprocessed film to the delivery of a dry radiograph--in general range downward from 15 minutes. Because one stage of the cycle may have to be longer than another, the racks may vary in size--the longer the assembly, the longer the film takes to pass through a particular stage of processing.

Although the primary function of the transport system is to move the film through the processor in a precisely controlled time, the system performs two other functions of importance to the rapid production of high-quality radiographs. First, the rollers produce vigorous uniform agitation of the solutions at the surfaces of the film, contributing significantly to the uniformity of processing. Second, the top wet rollers in the racks and the rollers in the crossover assemblies effectively remove the solutions from the surfaces of the film, reducing the amount of solution carried over from one tank to the next and thus prolonging the life of the fixer and increasing the efficiency of washing. Most of the wash water clinging to the surface of the film is removed by the squeegee rollers, making it possible to dry the processed film uniformly and rapidly, without blemishes.

Water System

The water system of automated processors has two functions - to wash the films and to help stabilize the temperature of the processing solutions. Hot and cold water are blended to the proper temperature and the tempered water then passes through a flow regulator which provides a constant rate of flow. Depending upon the processor, part or all of the water is used to help control the temperature of the developer. In some processors, the water also helps to regulate the temperature of the fixer. The water then passes to the wash tank where it flows through and over the wash rack. It then flows over a weir (dam) at the top of the tank and into the drain.

Sometimes the temperature of the cold water supply may be higher than required by the processor. In this situation, it is necessary to cool the water before piping it to the processor.

This is the basic pattern of the water system of automated processors; the details of the system may vary slightly, however.

Recirculation Systems

Recirculation of the fixer and developer solutions performs the triple functions of uniformly mixing the processing and replenisher solution, maintaining them at constant temperatures, and keeping thoroughly mixed and agitated solutions in contact with the film.

The solutions are pumped from the processor tanks, passed through devices to regulate temperature, and returned to the tanks under pressure. This pressure forces the solutions upward and downward, inside, and around the transport system assemblies. As a result of the vigorous flow in the processing tanks, the solutions are thoroughly mixed and agitated and the films moving through the tanks are constantly bathed in fresh solutions.

Replenishment Systems

Accurate replenishment of the developer and fixer solutions is even more important in automated processing than in manual processing. In both techniques, accurate replenishment is essential to proper processing of the film and to long life of the processing solutions; but, if the solutions are not properly replenished in an automated processor, the film may swell too much and become slippery, with the result that it might get stuck in the processor.

When a film is fed into the processor, pumps are activated, which pump replenisher from storage tanks to the processing tanks. As soon as the film has passed the entrance assembly, the pumps stop--replenisher is added only during the time required for a sheet of film to pass through the entrance assembly. The amount of replenisher added is thus related to the size of the sheet of film. The newly added replenisher is blended with the processor solutions by the recirculation pumps. Excess processing solutions flow over a weir at the top of the tanks into the drain.

Different types of x-ray films require different quantities of processing chemicals. It is, therefore, important that the solutions be replenished at the rate proper for the type or types of film being processed and the average density of the radiographs.

Replenishment rates must be measured accurately and checked periodically. Overreplenishment of the developer is likely to result in lower contrast; slight underreplenishment results in gain of speed and contrast, but severe underreplenishment results in a loss of both. Severe underreplenishment of developer can cause not only loss of density and contrast but also failure of the film to transport at any point in the transport system. Overreplenishment of the fixer does not affect good operation, but is wasteful. However, underreplenishment results in poor fixation, insufficient hardening, inadequate washing, and possible failure of the film to be transported in the fixer rack or at any point beyond.

Dryer System

Rapid drying of the processed radiograph depends on proper conditioning of the film in the processing solutions, effective removal of surface moisture by the squeegee rollers, and a good supply of warm air striking both surfaces of the radiograph.

Heated air is supplied to the dryer section by a blower. Part of the air is recirculated; the rest is vented to prevent buildup of excessive humidity in the dryer. Fresh air is drawn into the system to replace that which is vented.

Rapid Access to Processed Radiographs

Approximately twelve or fourteen minutes after exposed films are fed into the unit, they emerge processed, washed, dried, and ready for interpretation. Conservatively, these operations take approximately 1 hour in hand processing. Thus, with a saving of at least 45 minutes in processing time, the holding time for parts being radiographed is greatly reduced. It follows that more work can be scheduled for a given period because of the speed of processing and the consequent reduction in space required for holding materials until the radiographs are ready for checking.

Uniformity of Radiographs

Automated processing is very closely controlled time-temperature processing. This, combined with accurate automatic replenishment of solutions, produces day-after-day uniformity of radiographs rarely achieved in hand processing. It permits the setting up of exposure techniques that can be used with the knowledge that the films will receive optimum processing and be free from processing artifacts. Processing variables are virtually eliminated.

Small Space Requirements

Automated processors require only about 10 square feet of floor space. The size of the processing room can be reduced because hand tanks and drying facilities are not needed. A film loading and unloading bench, film storage facilities, plus a small open area in front of the processor feed tray are all the space required. The processor, in effect, releases valuable floor space for other plant activities. If the work load increases to a point where more processors are needed, they can be added with minimal additional space requirements. Many plants with widely separated exposure areas have found that dispersed processing facilities using two or more processors greatly increase the efficiency of operations.

Chemistry of Automated Processing

Automated processing is not just a mechanization of hand processing, but a system depending on the interrelation of mechanics, chemicals, and film. A special chemical system is therefore required to meet the particular need of automated processing.

When, in manual processing, a sheet of x-ray film is immersed in developer solution, the exposed silver halide grains are converted to metallic silver, but, at the same time, the emulsion layer swells and softens. The fixer solution removes the underdeveloped silver halide grains and shrinks and hardens the emulsion layer. Washing removes the last traces of processing chemicals and swells the film slightly. Drying further hardens and shrinks the emulsion. Therefore, the emulsion changes in thickness and in hardness as the film is moved from one step to the next in processing. In manual processing, these variations are of no importance because the films are supported independently and do not come in contact with other films or any other surfaces.

Automated processing, however, places an additional set of demands on the processing chemicals. Besides developing and fixing the image very quickly, the processing chemicals must prevent the emulsion from swelling or becoming either slippery, soft, or sticky. Further, they must prepare the processed film to be washed and dried rapidly.

In automated processors, if a film becomes slippery, it could slow down in the transport system, so that films following it could catch up and overlap. Or it might become too sticky to pass some point and get stuck or even wrap around a roller. If the emulsion becomes too soft it could be damaged by the rollers. These occurrences, of course, cannot be tolerated. Therefore, processing solutions used in automated processors must be formulated to control, within narrow limits, the physical properties of the film. Consequently, the mixing instructions with these chemicals must be followed exactly.

This control is accomplished by hardener in the developer and additional hardener in the fixer to hold the thickness and tackiness of the emulsion within the limits required for reliable transport, as well as for rapid washing and drying.

It is also desirable that automated processing provide rapid access to a finished radiograph. This is achieved in part by the composition of the processing solutions and in part by using them at temperatures higher than those suitable for manual processing of film.

The hardening developer develops the film very rapidly at its normal operating temperature. Moreover, the formulation of the solution is carefully balanced so that optimum development is achieved in exactly the time required for the hardener to harden the emulsion. If too much hardener is in a solution, the emulsion hardens too quickly for the developer to penetrate sufficiently, and underdevelopment results. If too little hardener is in the solution, the hardening process is slowed, overdevelopment of film occurs, and transport problems may be encountered. To maintain the proper balance, it is essential that developer solution be replenished at the rate proper for the type or types of film being processed and the average density of the radiographs.

Because washing, drying, and keeping properties of the radiograph are closely tied to the effectiveness of the fixation process, special fixers are needed for automatic processing. Not only must they act rapidly, but they must maintain the film at the proper degree of hardness for reliable transport. Beyond this, the fixer must be readily removed from the emulsion so that proper washing of the radiograph requires only a short time. A hardening agent added to the fixer solution works with the fixing chemicals to condition the film for washing and for rapid drying without physical damage to the emulsion.

Experience has shown that the solutions in this chemical system have a long life. In general, it is recommended that the processor tanks be emptied and cleaned after 50,000 films of mixed sizes have been processed or at the end of 3 months, whichever is sooner. This may vary somewhat depending on local use and conditions; but, in general, this schedule will give very satisfactory results.

Film-Feeding Procedures

Sheet Film

Figure 78 shows the proper film-feeding procedures. The arrows indicate the direction in which films are fed into the processor. Wherever possible, it is advisable to feed all narrower films side by side so as to avoid overreplenishment of the solutions. This will aid in balanced replenishment and will result in maximum economy of the solutions used.

Care should be taken that films are fed into the processor square with the edge of a side guide of the feed tray, and that multiple films are started at the same time.

In no event should films less than 7 inches long be fed into the processor.

Figure 78: Film-feeding procedures for KODAK INDUSTREX Processors.

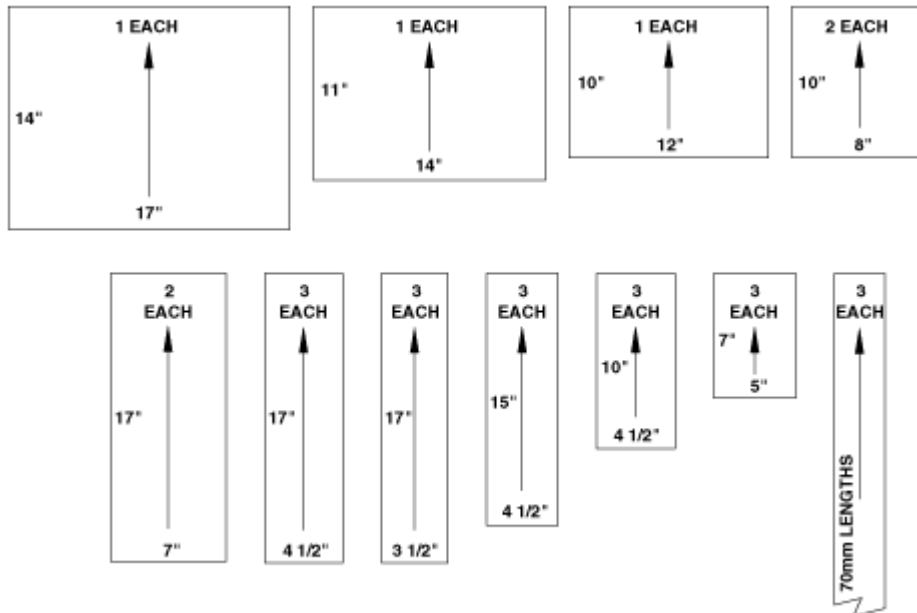

Roll Film

Roll films in widths of 16 mm to 17 inches and long strips of film may be processed in a KODAK INDUSTREX Processor. This requires a somewhat different procedure than is used when feeding sheet film. Roll film in narrow widths and many strips have an inherent curl because they are wound on spools. Because of this curl, it is undesirable to feed roll or strip film into the processor without attaching a sheet of leader film to the leading edge of the roll or strip. Ideally, the leader should be unprocessed radiographic film. Sheet film that has been spoiled in exposure or accidentally light-fogged can be preserved and used for this purpose.

The leader film should be at least as wide as, and preferably wider than, the roll film and be a minimum of 10 inches long. It is attached to the roll film with a butt joint using pressure-sensitive polyester tape, such as *SCOTCH* Brand Electrical Tape No. 3, one inch in width. (Other types of tape may not be suitable due to the solubility of their bases in the processing solutions.) Care should be taken that none of the adhesive side of the tape is exposed to the processing solutions. Otherwise, the tape may stick to the processor rollers or bits of adhesive may be transferred to the rollers, resulting in processing difficulties.

If narrow widths of roll or strip films are being fed, they should be kept as close as possible to one side guide of the feed tray. This will permit the feeding of standard-size sheet films at the same time. Where quantities of roll and strip films are fed, the replenisher pump should be turned off for a portion of the time. This will prevent overreplenishment and possible upset of the chemical balance in the processor tanks.

Filing Radiographs

After the radiograph is dry, it must be prepared for filing. With a manually processed radiograph, the first step is the elimination of the sharp projections that are caused by the film-hanger clips. Use of film corner cutters will enhance the appearance of the radiograph, preclude its scratching others with which it may come in contact, facilitate its insertion into an envelope, and conserve filing space.

The radiograph should be placed in a heavy manila envelope of the proper size, and all of the essential identification data should be written on the envelope so that it can be easily handled and filed. Envelopes having an edge seam, rather than a center seam, and joined with a nonhygroscopic adhesive are preferred, since occasional staining and fading of the image is caused by certain adhesives used in the manufacture of envelopes. Ideally, radiographs should be stored at a relative humidity of 30 to 50 percent.

See "American Standard Requirement for Photographic Filing Enclosures for Storing Processed Photographic Films, Plates and Papers," PH1.53-1978, or the latest revision thereof. Available from American National Standards Institute Inc., 1430 Broadway, New York, NY 10018.

Chapter 11: Process Control

Users of industrial radiography must frequently meet requirements of density and sensitivity set forth in inspection specifications. They must also keep the radiograph rejection rate to a minimum. Control of variability in both exposing and film processing is essential if these requirements are to be met. Although exposure and processing are the most frequent sources of significant variations, other factors, such as intensifying screens and film, also contribute to radiographic variability.

The exposure of industrial x-ray film to energy in the visible spectrum is *not* a reliable indicator of the process level or the repeatability of exposures to x-radiation. Therefore, exposure of the control film to white light is *not* a satisfactory tool for controlling process variability in industrial radiography. In the procedure for controlling either the exposing unit or the film processing, or both, described here, x-radiation is used to expose the control film.

The data obtained from exposures to x-radiation can be utilized in many ways. The procedure is simple and not only reveals both exposing and processing variations but also differentiates between them. It can be customized to fit specific requirements; a few suggestions for doing so are presented later. No attempt has been made to list all the measures available for reducing variations in density inasmuch as the procedures required for adequate process control depend on the conditions in the laboratory and production specifications.

Equipment And Materials

Most of the equipment and the material needed to set up a meaningful program of process control is readily available to industrial radiographers. The key items are:

Electronic Direct-Reading Densitometer

Accurate, precise densitometers capable of measuring diffuse density are available from dealers in photographic supplies.

Calibrated Film Strip

The strip is used to check the precision of the densitometer. If one is not available, a control strip on which previous readings have been recorded will suffice.

Stepped Wedge

The wedge should be made of steel or the material most often tested. One step should be thick enough to permit the passage of radiation sufficient to produce a density of 0.6 to 1.0, another step should be thin enough to permit passage of twice as much radiation to produce a density of 2.0 or higher. Although not essential, it is helpful if the difference in the density produced by adjacent steps is uniform.

Film

A box of industrial x-ray film of the type most frequently used in the normal production operation should be reserved for the control program. Before all the film in this box has been used, a new box should be reserved for the same purpose and the necessary data on the response of the new film should be obtained.

Refrigerator

After exposure, control strips must be stored at 40°F (4.5°C) or lower. When the stock of control film exceeds a six-week supply, the unexposed film should be stored in a refrigerator and no more than a one-week supply should be removed at any one time. When the temperature and the humidity are high (more than 75°F or 24°C and 50 percent relative humidity), unexposed film should be refrigerated regardless of the size of the stock.

Cassette

One cassette or film holder for each exposing unit in the operation should be reserved for exclusive use in exposing control film in that unit.

Intensifying Screens

If lead intensifying screens are used in the normal production operation, one set should be reserved for exclusive use in exposing control film.

Electronic Thermometer with Submersible Stainless Steel Probe

This is an essential item if two or more automatic processors are operated at a common density aim that has close tolerances. It is also helpful in reducing variations in density attributable to processing in an automatic processor.

General Aspects

The information that follows pertains to the central system as a whole. Specific details of exposing, processing, use of data accumulated, and the like are presented later.

Procedure

Establish a specific exposure technique for each x-ray unit in the control system. A separate technique for each unit is essential because of variability in units of the same design and variations among units of different designs. Each time control film is exposed in a unit, the technique established for that particular unit must be followed exactly.

Routinely check the accuracy and the precision of the densitometer using the calibrated film strip or a control strip on which previous readings has been recorded.

Maintain a separate process control chart for each exposing unit in the control system.

Maintain a separate process control chart for each processor in the control system unless two or more processors are kept operating at a common level.

Expose control film each day in a designated unit. The exposed film is cut into enough strips to provide a minimum of two strips for each processor in the operation. More than the minimum number of strips are cut if possible.

Identify each strip.

Place half of the strips in an airtight, light tight container; put the container in a moisture proof bag (a bag made of polyethylene, for example); and place the package in the refrigerator to minimize fading of the latent image. The strips are kept *in the refrigerator* for processing with freshly exposed strips the following day. (A freshly exposed control strip is always processed with a refrigerated control strip exposed in the same unit the previous day.)

Tape the control strips to a leader if they are to be processed in an automated processor. This will provide better transport. If they are to receive rack-and-tank processing, it may be necessary to make a special strip hanger or to adapt a standard film hanger in order to hold the strips securely. The control strips should always be processed with the high-density end down.

Maintain an accurate, up-to-date log containing all information that could affect process control. The following should be included in the log:

1. Maintenance data and changes resulting from readjustment of an exposing unit, including the supply of electrical current to the unit and any significant changes in line voltage.
2. Maintenance data and changes resulting from readjustment of a processor.

3. Age of the developer replenisher.
4. Replenishment rate of the developer.
5. Age of the developer.
6. Temperature of the developer at the time control strips are being processed.
7. Comments on fixer and wash and their replenishment rates. (Although the condition of the fixer and the wash does not noticeably affect the variability of film densities, the condition of each does have an effect on the physical quality of processed film.)

Process Control Charts

Two steps on the control strip are selected for measurement. One step should have a density of 0.6 to 1.0; the other, 2.0 or higher. A specific area of the step is selected for measurement, and that same area on each of the two steps is measured to obtain a high-density value and a low-density value. From the first day on, four values are obtained--the value of the high-density step and the value of the low density step on the fresh control strip and the values of the corresponding steps on the control strip exposed the preceding day--always in the same area on each step.

The upper and the lower control limits for the process density aim can be assigned arbitrarily on the basis of acceptable tolerances in the process operation (2.0 ± 0.2 , for example). Sometimes it is desirable to calculate more precise control limits, however, and a statistical method, such as the standard deviation of density values with three sigma control limits, can be used to determine the limits. If the standard deviation with three sigma control limits is used, 95 percent of all data collected should be within the limits. (The method of calculating the standard deviation with three sigma control limits, which is given in most books on statistical quality control, has been described in relatively simple terms by Mason -- Mason, R. D.: *Statistical Techniques in Business and Economics*. Monograph in Irwin Series in Quantitative Analysis for Business. Published by Richard D. Irwin, Inc., Homewood, Illinois, 1970, pp. 116-123, 314-329.)

When a new box of control film is introduced into the operation, control exposures are made on both the old and the new stock for four days and a temporary process density aim is computed on the basis of the average densities obtained during the four-day period. After 10 days, the process density aim, or the mean density, is recomputed on the 10-day average.

The process density aim is reestablished whenever changes are made within the operation. Such changes as the introduction of a new control film and alterations to the exposing unit, for example, make it necessary to reestablish the aim.

Control limits for variables of the exposing unit and the film processing are wider than if either were monitored individually.

The densitometric data obtained from the control strips can be utilized in several ways. The table below shows densitometric readings for a 10-day period. Some of the data in Figure 78 are plotted on one process control chart (See Figure 80) to show variations in exposure and processing; some are plotted on another process control chart (See Figure 81) to indicate changes in contrast.

Figure 79: Densitometric data for process control in industrial radiography accumulated in accordance with the procedure described in the text. In each of the two pairs of figures shown for each day except the first and the weekend, the top figure is the reading determined from the control strip exposed one or three days before--the latent-image control strip. The bottom figure is the reading determined from the control strip exposed and processed that day--the fresh-image control strip. In this example, the density difference is the difference between the high-density reading and the low-density reading of the fresh control strip. Latent-image control strips serve equally well for determining density difference.

Densitometric Data for Industrial X-ray Process Control												
	Mon.	Tues.	Wed.	Thurs.	Fri.	Sat.	Sun.	Mon.	Tues.	Wed.	Thurs.	Fri.
High-density reading	1.95	2.12										
		1.90	1.85									
			2.15	2.00								
				1.70	1.80							
					1.95	--	--	1.85				
								2.05	2.00			
									1.95	1.80		
										1.90	1.95	
											2.05	1.95
												2.00
Low-density reading	0.82	0.91										
		0.71	0.74									
			1.03	0.90								
				0.61	0.64							
					0.80	--	--	0.80				
								1.01	0.97			
									0.92	0.72		
										0.80	0.88	
											0.95	0.75
												0.80
Density difference	1.13	1.19	1.12	1.09	1.15	--	--	1.04	1.03	1.10	1.10	1.20

Figure 80: Control chart below for one exposing unit and one processor showing variations in exposure and processing. The control limits are wider than if either exposure or processing were monitored individually. Plot all the high-density readings, but connect only the readings from control strips exposed at the same time. The connecting lines represent the day-to-day repeatability of film processing; the difference between point plots on a given day represents the repeatability of exposure.

Process Control Chart--Exposure and Processing Variations													
		Mon.	Tues.	Wed.	Thurs.	Fri.	Sat.	Sun.	Mon.	Tues.	Wed.	Thurs.	Fri.
Upper control limit	2.15												
Process density aim	1.95												
Lower control limit	1.75												

Process Control Technique

Certain measures can be taken to reduce radiographic process variability, but they depend largely on the conditions and the requirements of the individual user. This is particularly true with respect to variations introduced by the exposing unit. Obvious causes of exposure variability, such as fluctuations or changes in line voltage, must first be eliminated, of course. The following may be of help in reducing variations in density attributable to processing of the film in an automated processor.

Use the electronic thermometer with the submersible stainless steel probe to set the temperature of the developer. Use it to check for fluctuations in developer temperature; the thermostat for the developer may allow the temperature to vary by 2°F. Procedures and thermostats that will hold the temperature of the developer to ±1/5°F are available.

Use a graduate frequently to check and to maintain the developer replenisher rate at that recommended for the average film density in the process.

Keep processing of completely exposed film or completely unexposed film to a minimum. Developer that is overreplenished generally causes an increase in film densities; developer that is underreplenished generally causes a decrease in film densities. When the stage of underreplenishment reaches a certain point, the rate at which film densities decrease may become quite rapid.

Never permit the developer replenisher to age beyond its recommended storage life. If the developer replenisher exceeds its storage life, the storage tank should be emptied and rinsed and a fresh solution should be prepared. Do not mix fresh developer replenisher with a solution that is near the limit of its recommended storage life.

Do not replenish with developer replenisher that is past its recommended storage life. Do not replenish with oxidized developer replenisher. The results of these practices can be losses in density, a shift in contrast, or both.

Use fresh solutions at the time a process control system is initiated to reduce the possibility of establishing a process density aim base on a process that is abnormal.

When the processed control strips indicate an out-of-control condition, check for an obvious error, such as the temperature of the developer (if a film processing error is indicated), or the technique

used to set up the exposing unit (if an exposure error is indicated), or poor densitometry. If an abnormal process is indicated, process another set of control strips. (It is for this purpose that more than the minimum of two strips for each processor is advisable.)

When an out-of-control condition does exist that is the result of a film processing variation and not an obvious testing error, the process should be restarted with fresh solutions. Adding chemicals to the developer is frequently unsuccessful, is more time consuming, and is more expensive in the end than restarting the process. Contamination of the developer (1 mL of fixer in a gallon of developer can be detected in film densities) and underreplenishment of the developer are examples of conditions that indicate the process should be restarted with fresh solutions.

Technique

Exposure of Control Film

Load the cassette with a sheet of control film. (If the control film has been refrigerated, be sure to allow enough time for the film to reach room temperature before handling.) If lead intensifying screens are used in the normal production operation, use the set reserved for process control.

Carefully set up the x-ray exposure unit for the exposure technique. The cassette and the stepped wedge must be positioned identically each time control film is exposed.

Cut the exposed film into a minimum of twice the number of processors in the control system. If possible, cut more than the minimum, but do not make duplicate exposures and assume they are identical. Each exposure of control film must be considered a complete control.

Identify the strips as to date and exposing unit.

Place half or the exposed control strips in an airtight, light tight, and moisture proof wrapper and store them in the refrigerator. Remove the moisture proof package of control strips exposed in the same unit the previous day. When these latent-image control strips are at room temperature, they can be handled and processed.

Processing of Control Strips

Process the freshly exposed control strips and the strips exposed in the same unit the previous day in the corresponding processor (or processors).

If the strips are less than 2 1/2 inches wide, tape them to a leader. If a leader is not used, process a cleanup sheet before processing the control strips.

Always process a fresh control strip exposed in a designated unit with a control strip exposed in that same unit the previous day.

Record in the log the temperature of the developer at the time the strips are in the processor. Record in the log any other information pertinent to process control.

Densitometry

Check the accuracy and the precision of the densitometer each time before it is used to obtain the numerical density values from the control strips.

Determine the density value of each of the two steps selected for measuring density on the freshly exposed and processed control strip and the density of the two corresponding steps on the latent-image control strip. (Once these steps have been selected, the density of the same area on each of the steps is used every time control strips are measured.)

Record the densitometric readings and plot them on the process control charts.

Discussion

Densitometric data and process control charts for one exposing unit and one processor are presented as Figures 79 to 80. The process density aim (the mean density) and the upper and lower control limits on the charts (the table immediately above and the one below) were computed from the densitometric data for the 10-day period shown in Figure 79. As stated earlier, the control limits on both charts are wider than would be the case if either the exposing unit or the processor were monitored individually. Although two control charts are illustrated, they can be combined into one for convenience.

Exposure and Processing Variations

Variations in both exposure and processing are reflected on the process control chart reproduced as Figure 80. All the high-density readings are plotted, but only the readings from control strips exposed at the same time are connected. The lines represent the day-to-day repeatability of film processing, the difference between the point plots on a given day represents the repeatability of exposure.

Figure 81: Control chart for one exposing unit and one processor indicating changes in contrast. Plot the difference between the high-density reading and the low-density reading of the fresh-image control strips, and connect the plots. A decrease in density difference from the process density aim, or the mean density, indicates lower contrast; an increase indicates higher density.

Process Control Chart--Changes in Film Contrast													
		Mon.	Tues.	Wed.	Thurs.	Fri.	Sat.	Sun.	Mon.	Tues.	Wed.	Thurs.	Fri.
Upper control limit	1.30												
Process density aim	1.10												
Lower control limit	0.90												

There will be a slight density loss of the latent image on the control strips processed one to three days after exposure even though they are refrigerated. However, this small difference in density is no cause for concern with the type of control chart shown in Figure 80. If the density of the refrigerated control strip is always slightly lower (0.03 to 0.04) than that of its corresponding fresh control strip, the process is repeating identically.

Contrast Variations

Variations in film contrast are reflected on the control chart reproduced as Figure 81. The difference between the high-density reading and the low-density reading of the fresh-image control strips is plotted on this chart. (Latent-image control strips serve equally well for determining density difference.) A decrease in density difference from the mean density, or the process density aim, indicates lower contrast, an increase in density difference indicates higher contrast.

Chapter 12: The Processing Room

The location, design, and construction of the x-ray processing facilities are major factors in the installation of adequate radiographic services. These facilities may be a single room, or a series of rooms for individual activities, depending on the amount and character of the work performed. Because of the special importance of these rooms for the handling, processing, and storing of x-ray films, both their general and detailed features should be most thoughtfully worked out. When planning reflects care and foresight, the effort expended is soon offset by ease of operation, improved production, and lowered costs of maintenance.

The flow of x-ray films from the radiographic room, through the processing facilities, to the viewing room should be a simple yet smooth operation requiring the fewest possible steps. The routine can be expedited by proper planning of the location within the department of the room or rooms devoted to processing, and by efficient arrangement of the equipment.

Ideally, processing rooms should be supplied with filtered air, at a pressure above that of the outside. This is particularly important when the outside air is likely to be contaminated with sand, dirt, or other airborne particles.

Processing Area

The volume of films to be handled in the department, and the importance of rapid access to the finished radiographs, will determine whether manual or automatic processing will be used.

Manual Processing

If the work load is small or intermittent, a single room containing all of the facilities can be used (See Figure 82). However, if the volume of manual processing is relatively high, production can be expedited by dividing the operations among three areas: A room for loading and unloading cassettes; a processing room with a through-the-wall tank; and a washing and drying room.

In general, the manual processing room should be large enough to hold all the necessary equipment without crowding. However, there is no advantage in having excessive floor space, although need for future expansion should be anticipated. The room shown in the figure below will permit the processing of more than 200 films a day, and can be constructed in a floor space 91/2 x 15 feet.

It is most efficient to have the processing area adjoin the exposure room. However, in departments where highly penetrating radiation is used, the amount of radiation shielding needed to protect personnel and film may be prohibitively expensive, in which case the processing room must be located at a safe distance.

Figure 82: Plan of a manual x-ray processing room.

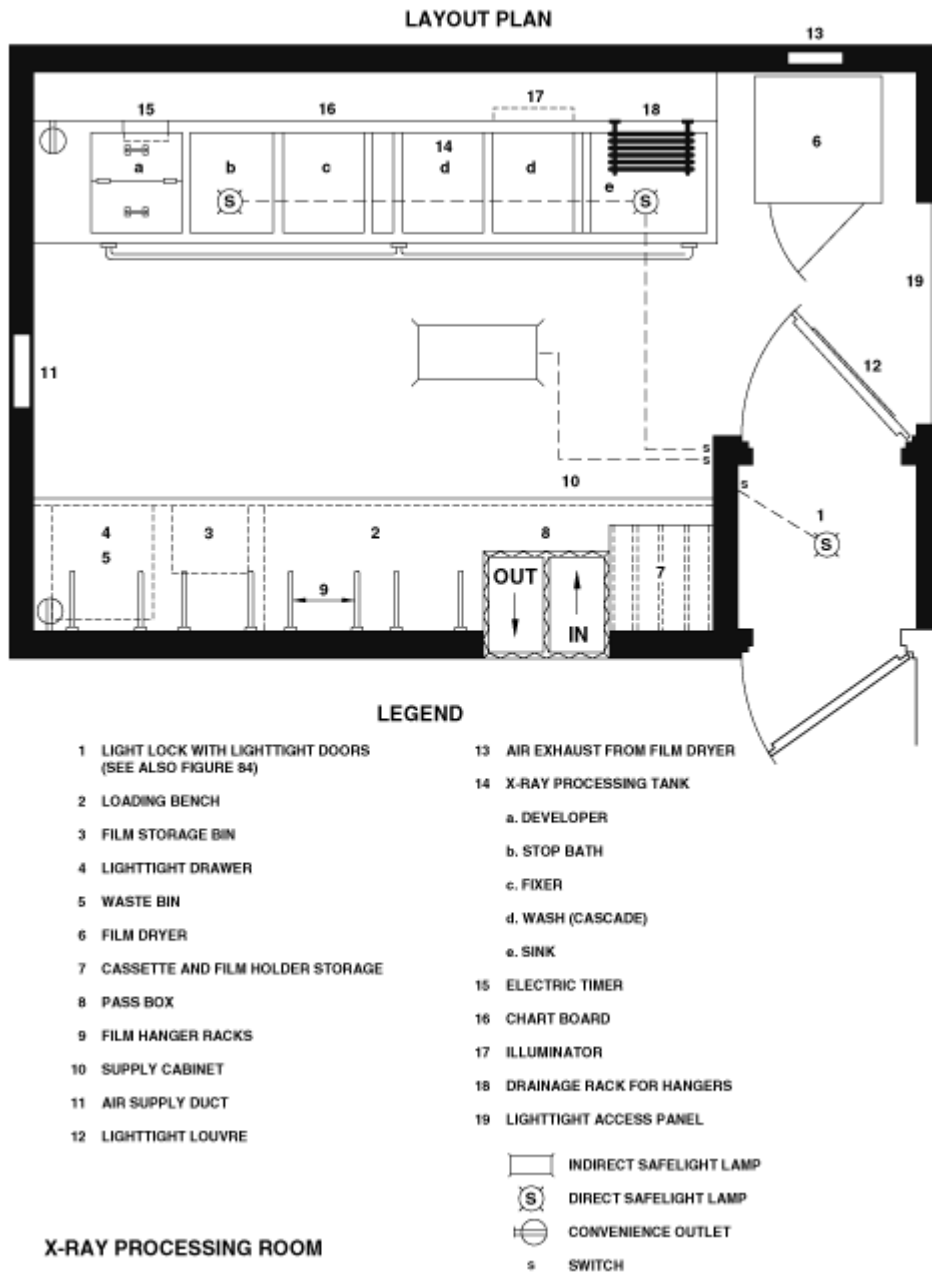

Loading Bench

Basically, operations performed in the processing areas should be separated into parts--the "dry" and the "wet." The dry activities--such as the handling of unprocessed film, loading and unloading of cassettes and exposure holders, and the loading of processing hangers--are all done at the loading bench. This may be either opposite the processing tanks in the same room or in a separate adjacent room. Where a cassette-transfer cabinet is used, it should open onto the loading bench, which should provide facilities for storage of processing hangers and other items, and a light tight film bin. Items such as the transfer cabinet, film storage bin, and processing hanger brackets are commercially available.

Processing Tanks

Processing the films, which involves the wet activities of developing, stopping, fixing, and washing, should be carried out in an area separate from the loading bench. This arrangement is designed to avoid splashing solutions on screens, films, and loading areas and, in general, to prevent interference with loading-bench operations.

The tanks must be constructed of a corrosion-resistant material. The majority are now being fabricated of AISI Type 316 stainless steel with 2 to 3 percent of molybdenum. Special techniques must be employed in the fabrication of these tanks to avoid corrosion in the welded areas.

The film capacity of the entire processing area is determined by the size of the insert tanks. Based on a 5-minute development time, a 5-gallon developer tank can handle 40 films an hour with four hangers being handled simultaneously, and allowing for the time during which the hangers are removed and inserted in the stop bath. The capacity of the stop bath tank should be equal to that of the developer tank, and the fixer tank should be at least twice as large as the developer tank. The washing tank should hold at least four times the number of hangers accommodated in the developer tank.

Film Dryers

One of the important considerations in designing the processing area is the film dryer. It should be fast-acting without overheating the film. Hot air, infrared, and desiccant dryers are commercially available. Whenever possible, a filter should be inserted in the airtake. This may, however, create such a resistance to the airflow as to require a fan of larger capacity than would be needed without the filter. A removable drip pan beneath each film compartment or drawer is useful as an aid in keeping the dryer clean. As a precaution, heating elements should be connected in the fan circuit so that heat cannot be turned on without turning on the fan.

Automated Processing

The chief difference between processing rooms for manual and automated processing is the absence of the space-consuming processing tanks. The only part of the automated processor that need be in the processing room is the film-feeding station, and this is quite small. The plans can follow the general form of Figure 83. Note the provision in the outer (light) room for mixing and storing processing chemicals and washing processor components.

In planning a new processing room for an automated processor, early consideration should be given to providing the water, electrical, drainage, and exhaust facilities required by the processor.

Figure 83: A schematic diagram of an automated processing darkroom and adjacent light-room area.

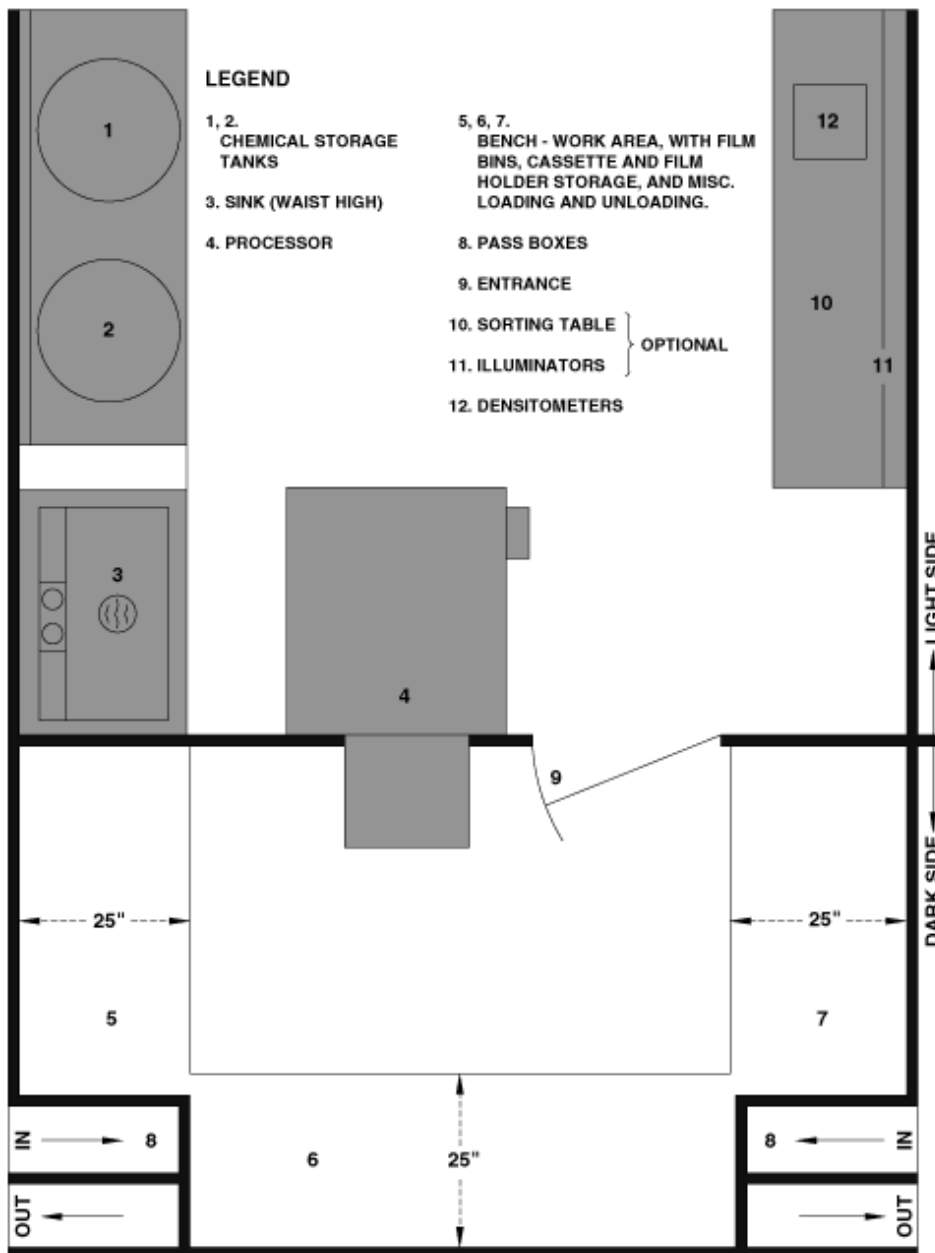

General Considerations

There are a number of considerations that apply to all processing rooms, whether for manual or automatic processing.

Entrances

Three general types of entrances are used for the processing room: The single door, the light lock (double or revolving doors), and the labyrinth or maze. The single door is shown in the figure immediately above and a double-door light lock in the figure way above.

Which is best suited to a particular installation is determined largely by the traffic in and out of the processing room and by the amount of floor space available. The single door equipped with an inside bolt or lock is most economical of floor space and is practical where one employee handles the processing. However, in most cases a labyrinth, or a vestibule with two interlocking doors, is generally employed. Plans for the double-door and revolving door light locks, as well as a labyrinth, are shown in Figure 84.

Figure 84: Light locks (left and right) and maze (center) allow continuous access to the processing room.

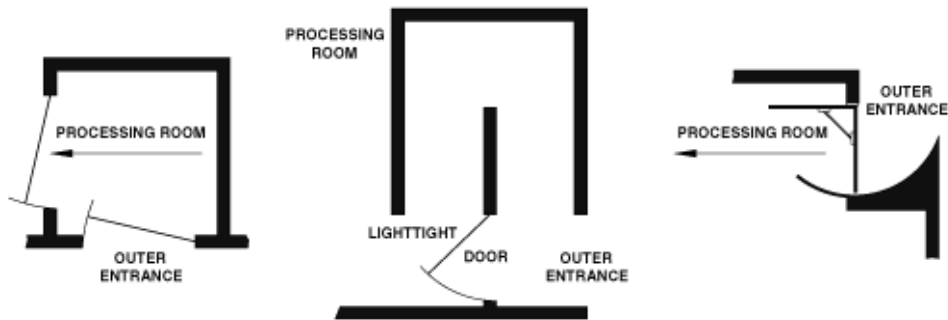

Wall Covering

The walls of the processing room can be of any pleasing color. A cream or buff will give maximum reflectance for safelight illumination. A good semigloss paint is satisfactory for any wall where chemicals are not likely to be splattered. The best protective materials for walls near the processing tanks in a manual processing room or in a chemical mixing area are ceramic tile, structural glass sheets, or stainless steel. Care should be taken in choosing tile since there have been instances when radioactive material has been incorporated in the glaze of the tile. Corrosion- and stain-resistant paints are available but do not have the permanence of stainless steel, tile, or structural glass.

Floor Covering

The ideal floor is resistant to chemical corrosion and staining, of waterproof installation, of a suitable color, and free from slipperiness. Porcelain and the natural clay tiles are satisfactory, as are the darker asphalt tiles. Linoleum, and plastic and rubber tiles are less desirable because they may be stained or pitted by the processing solutions.

Plumbing

In drainage lines, the greatest problem encountered is corrosion. Stainless steel, glass, chemical stoneware, and anticorrosion iron are usually satisfactory. Galvanized steel may be used when waste solutions do not remain in pipes. Under no circumstances should two metals be used, such as copper pipe with galvanized steel fittings, because of the likelihood of corrosive electrolytic action. Plastic fittings will eliminate this problem.

Lines carrying processing or replenisher solutions from storage tanks must be of stainless steel, glass, plastic, or other inert, corrosion-resistant material.

Illumination

The processing area must be provided with both white light and safelight illumination. White light is desirable for many activities, including cleaning and maintenance.

Since excessive exposure of film to safelight illumination will result in fog, the arrangement of the safelight lamps must be carefully considered. A manual processing room should be divided into three zones of safelight intensity: The brightest, in which the films are washed and placed in the dryer; the medium zone, where films are developed and fixed; and the dimmest zone, where

loading-bench activities are carried on. Only one level of illumination is usually provided in a processing room for automatic processing, since the manipulation of unprocessed film is reduced to a minimum.

The "safeness" of processing room illumination depends equally on the use of the proper safelight filter, the use of the proper wattage of bulb, the proper placement of lamps with respect to film, and not exceeding the maximum "safe" time of exposure of the film to safelight illumination.

Exposed films are more sensitive to fogging from the safelight illumination than are unexposed films. Hence, it is especially important to guard the exposed films against prolonged exposure to safelight illumination. Note that the screen-type films are more sensitive to fogging by safelight illumination than direct-exposure films.

A simple method of checking the safelight of illumination is to test it with the fastest film used in the laboratory, as follows: An exposure is made of a stepped wedge. In the processing room, the holder is unloaded and the film placed in the area where it is normally handled. Part of the film is covered with opaque paper. The remainder is exposed to the safelight illumination for the maximum time normally needed for handling. The test film is then given standard processing. If no density shows on the uncovered part that received the safelight exposure, as compared with the covered part, the lighting may be assumed to be safe.

Chapter 13: Special Processing Techniques

There are a number of special techniques useful in the processing of x-ray films. Some are applicable to both manual and automatic processing and others only to manual. Certain radiographic installations may use one or more of these routinely; others may employ them as circumstances warrant.

Intensification Of Underexposed Radiographs

Every industrial radiographic department occasionally encounters a radiograph that has been underexposed, either through an oversight or because of insufficient machine capacity. If the radiograph cannot be repeated because the time required for proper exposure would be prohibitively long, or if the item is no longer available, the underexposed negative can in many cases be salvaged. Chemical intensification of the completely processed film may, under certain circumstances, result in a speed gain of a factor of 5 to 7, while still retaining acceptable radiographic quality.

Films may be intensified immediately after fixation, or after they have been fully washed and dried. In either case, the films are washed in running water for 5 to 10 minutes, hardened in KODAK Special Hardener SH-1 (formula given below), and again washed for 5 minutes.

KODAK Special Hardener SH-1		
	Avoirdupois, U.S. Liquid	Metric
Water	16 fl oz	500 mL
KODAK Formaldehyde, about 37% solution by weight	2 $\frac{1}{2}$ fl oz	10.0 mL
KODAK Sodium Carbonate (Monohydrated)	90 grains	6.0 grams
Water to make	32 fl oz	1.0 litre

They are then treated, one at a time, for up to 10 minutes in KODAK Intensifier In-6. The working intensifier is mixed from the stock solutions (formulas given below) by taking one part of Solution A, and adding in succession two parts of Solution B, two parts of Solution C, and finally one part of Solution A. The order of mixing is important and should be followed. The hardening and intensification can conveniently be done in trays. The film should be agitated frequently during intensification, after which it is washed for 20 to 30 minutes in running water and dried normally.

Warning



Always add the sulfuric acid to the water slowly, stirring constantly, and never the water to the acid; otherwise, the solution may boil and spatter the acid on the hands and face, causing serious burns.

The water used for mixing the solutions for the intensifier should not have a chloride content greater than about 15 parts per million (equivalent to about 25 parts sodium chloride per million); otherwise, the intensification will be impaired. If in doubt as to chloride content, use distilled water.

KODAK Quinone-Thiosulfate Intensifier In-6		
	Avoirdupois, U.S. Liquid	Metric
Solution A		
Water	96 fl oz	750 mL
Sulfuric acid (concentrated)	4 fl oz	30.0 mL
KODAK Potassium Dichromate (anhydrous)	3 ounces	22.5 grams
Water to make	1 gallon	1.0 litre
Solution B		
Water	96 fl oz	750 mL
KODAK Sodium Bisulfite (anhydrous)	1/2 ounce	3.8 grams
KODAK Hydroquinone	2 ounces	15 grams
KODAK PHOTO-FLO 200 Solution	1/2 fl oz	3.8 mL
Water to make	1 gallon	1.0 litre
Solution C		
Water	96 fl oz	750 mL
KODAK Sodium Thiosulfate (Hypo)	3 ounces	22.5 grams
Water to make	1 gallon	1.0 litre

The intensification may be carried out in room light. During treatment, the film may be viewed on an illuminator and the process stopped at any time that the results suit the operator. Intensification in In-6 produces a rather grainy, yellowish image, which is not quite as permanent as a properly fixed and washed silver image. However, sufficient improvement is made in the radiographic sensitivity of underexposed radiographs to make these drawbacks relatively minor.

Because the intensified image is destroyed by acid hypo, under no circumstances should the intensified negatives be placed either in a fixing bath or in wash water contaminated with fixing bath. Films to be intensified should be handled as little as possible, and then only by the edges or corners.

The stock solutions from which the intensifier is mixed will keep in stoppered bottles for several months, and the mixed intensifier is stable for 2 to 3 hours. The bath should be used only once and then be discarded because a used bath may produce a silvery scum on the surface of the image.

Removal Of Fixing Agents

When, in manual processing, the capacity of the film washing tanks is insufficient, when time must be conserved, or when, as in field radiography, the water supply is limited, the use of KODAK Hypo Clearing Agent between fixation and washing is advantageous. This material permits a reduction of both the time and the amount of water necessary for adequate washing.

After fixation, the excess fixer is removed from the film by a 30-second rinse in water. It is then immersed in KODAK Hypo Clearing Agent solution for 1 to 2 minutes, with agitation. With this procedure, the capacity of the Hypo Clearing Agent bath will be about 750 to 1000 films (8 x 10-inch) or 250 to 330 films (14 x 17-inch) per 5 gallons of solution. If no rinse is used after fixation, the capacity of the bath will be reduced to about 200 to 300 films (8 x 10-inch). The bath should

be considered exhausted when that number of films has been processed, or sooner if a precipitation sludge appears. It must then be replaced, not replenished.

After treatment with the Hypo Clearing Agent, films should be washed for 5 minutes, using a water flow which will give a complete change of water 4 to 8 times per hour. However, if water supplies are severely limited, films may be washed in standing water, rather than running water, by soaking for 10 minutes with occasional agitation. The water in the wash tank should be replaced after 10 films (8 x 10-inch) per gallon have been washed.

The effectiveness of the washing procedure and the capacity of the Hypo Clearing Agent bath may be checked by testing a processed film for fixer removal as described in the following section.

Testing For Fixer Removal

Fixing chemicals not adequately removed from films by washing will, over a period of time, cause staining of the film and fading of the developed image. When it is known that films must be preserved indefinitely or when there is doubt as to the adequacy of the washing procedures, the amount of fixing chemicals remaining in the film after washing should be determined. This can be done in one of two ways.

Archival Washing

Film of archival interest--and this includes the majority of industrial radiographs for code work--should remain unchanged for long periods of time under good storage conditions (American National Standard Practice for Storage of Processed Safety Photographic Film, PH1.43-1979. Published by American National Standards Institute, Inc., New York, NY). Archival washing for this indefinite preservation of films is defined by American National Standards Institute (ANSI) documents in terms of the concentration of residual thiosulfate in the film. Acceptable methods for measurement are described in ANSI PH4.8-1971, "Methylene-Blue Method for Measuring Thiosulfate, and Silver Densitometric Method for Measuring Residual Chemicals in Film, Plates and Papers." (Available from American National Standards Institute, Inc., 1430 Broadway, New York, NY 10018) The methylene-blue method described in this document measures directly the concentration of thiosulfate iron. The silver-densitometric method measures thiosulfate as well as other residual chemicals and requires that a calibration curve be used relating the silver density produced to the thiosulfate content as measured by the methylene-blue method.

For test films or any other films intended for archival keeping, the method for determining residual thiosulfate should be chosen from those covered in the ANSI standard mentioned above. Note that while KODAK Hypo Estimator and KODAK Hypo Test Solution HT-2 (the HT-2 test) provide a quick, convenient means for estimating the amount of hypo (thiosulfate ion) retained in the emulsion, they cannot be used to determine the concentration of residual thiosulfate in terms of archival washing standards.

The methylene-blue method measures only thiosulfate. The technique is complex, and the sample must be tested within two weeks of processing. The silver densitometric method measures thiosulfate and other residual chemicals. The technique is simpler, and the results are not affected as much by the length of time between processing and testing. Like the HT-2 test, the silver densitometric method lacks sensitivity at low levels of thiosulfate. It is not sensitive enough to measure thiosulfate reliably below about 0.9 μg per square centimetre. The two procedures for the methylene-blue method described in ANSI PH4.8-1978 cover the range of 0.1 to 45 μg of thiosulfate ion ($\text{S}_2\text{O}_3^{--}$) per square centimetre of the test sample. This is the only method ANSI considers sufficiently reliable for determining such a low concentration as 0.7 μg of thiosulfate ion per square centimetre.

Methylene-Blue Method

Two variations of this method for measuring the concentration of residual thiosulfate are described in detail in ANSI PH4.8-1978. One covers a range of 0.1 to 0.9 μg of thiosulfate ion per square centimetre; the other, a range of 0.9 to 45 μg of thiosulfate ion per square centimetre. If the film is double coated, the residual thiosulfate ion is assumed to be divided equally between the two sides. Therefore, the concentration per square centimetre of emulsion is one-half of the total determined by either variant of the methylene-blue method. The maximum permissible concentration of residual thiosulfate ion for coarse-grain films, such as industrial x-ray films, is 3 μg of thiosulfate or 2 μg of thiosulfate ion per square centimetre.

Either way, testing must be done within two weeks of processing. Both require several reagents, a photometer or a spectrophotometer, and a calibration curve. Tests are conducted as follows:

Residual thiosulfate is extracted from a test sample and reduced to a sulfide. The sulfide reacts with test reagents to form methylene blue. The absorbance or the transmittance of the blue color is then measured with a photometer or a spectrophotometer, and the thiosulfate level is read from a calibration curve.

The methylene-blue method is a complex multi-step procedure that requires special materials and equipment and specialized analytic techniques not readily available to most industrial radiographers. Complete step-by-step directions for both procedures, including preparation of the test sample (which must be taken from an area of minimum density--preferably an unexposed but processed area), the various reagents, and the calibration curve, as well as information on the interpretation of results, are given in ANSI PH4.8-1978.

Removal Of One Emulsion From Double-Coated Film

In some applications of x-rays, for example, x-ray diffraction or microradiography, it may be desirable to avoid the parallax associated with an image on double-coated film.

The emulsion can be removed from one side of a processed x-ray film by the following procedure. The film is processed in the normal manner. It need not be dried unless desired. If dry, the film is fastened to a sheet of glass using waterproof tape, and the emulsion surface to be removed is rubbed with a cotton swab saturated with one-half normal potassium hydroxide (28 grams of potassium hydroxide per litre). If wet, it may be pressed firmly to a sheet of glass, and the potassium hydroxide solution applied, care being taken to prevent the solution from flowing onto the glass plate or in any way coming in contact with the bottom emulsion. Care must be exercised to prevent the dry chemical or the solution from coming in contact with the bare skin (use rubber gloves), clothing, or the emulsion surface that is to be preserved. After the film has been rubbed with the swab for about 1 minute, the emulsion is usually soft enough to be scraped off with a smooth, dull implement that will not scratch the film base--for example, a plastic windshield scraper. After the emulsion has been removed, the film is rinsed in running water, removed from the glass plate, and immersed in the fixing bath for a few seconds to neutralize any remaining caustic. It is then washed for about 20 minutes and dried, although a shorter washing period is acceptable if the film is not to be kept indefinitely.

Alternatively, the unwanted emulsion may be covered, prior to development, with some waterproof sheet material that will protect it from the action of the developer. The protective material is removed after development but before fixation. The time of fixation should be extended, since the undeveloped emulsion clears more slowly than does the developed one. Wash and dry according to standard procedure.

If the derived area is narrow, as in the case of a microradiograph or a powder x-ray diffraction pattern, it may be covered with a waterproof adhesive tape. It is inadvisable to overlap strips of

tape to cover wider areas because the adhesive coating of the tape does not always adhere tightly enough to the back of the adjoining layer to prevent leakage of the developer. Any tape used should be tested for its impermeability to developer, and to be certain that the adhesive adheres to the tape when the latter is removed rather than to the emulsion.

For larger areas, as in conventional radiography, two films may be taped together, with the unwanted emulsions in contact, and developed together. After development the films are separated, fixed, and washed individually. Alternatively, films may be taped, unwanted side down, to a discarded radiograph or a piece of film base, and removed after development but before fixation.

Tray Processing

This method is not as efficient as the tank system for the manual processing of x-ray films. However, when tanks are not available, satisfactory results can be obtained by employing trays and exercising the necessary care. The time and temperature recommendations for tank processing apply to tray processing.

Several glass, hard rubber, plastic, or enameled trays are essential. They should be large enough to accommodate the largest film that is used. One tray is used for developer solution, a second for stop bath or rinse water, a third for fixer solution, and a fourth for wash water.

In the tray system, a quantity of solution should be mixed at regular intervals and kept in glass bottles or glazed jugs. Then enough solution to cover the films to a depth of at least 1 inch is poured into the proper trays just before processing.

When the film is removed from the cassette, film holder, etc, a stainless steel clip should be attached to one corner to facilitate handling. The film is then immersed in the developer solution using a quick, sliding motion. If the emulsion is not covered evenly, a dark line will show in the radiograph where the solution pauses. Likewise, dark spots will appear on the film at points where spattered drops of developer strike the dried emulsion. During development, the film should be moved frequently and turned over so that the under side does not adhere to the tray and thereby retard the action of the chemicals. The tray should also be rocked in an irregular manner to provide continual mixing and redistribution of the solution over both surfaces of the film. Similar agitation is necessary in the fixer. Provision should be made for a constant flow of water in the wash tray. Care should be taken to be sure that radiographs do not cling to one another or stick to the bottom of the tray during the course of the washing process.

Commercial Washing

Films intended for ordinary commercial use should show no image change for several years under normal storage conditions. Adequate washing reduces the residual fixer content of a processed film to an acceptable level. The KODAK Hypo Estimator used with the KODAK Hypo Test Solution HT2 provides a simple, convenient method for measuring washing efficiency and can be used for cursory estimates of the keeping quality of films. It is especially useful for comparing variations within a test or for comparing several films in the same process. It has the additional advantages of being fast and easy to do.

KODAK Hypo Test Solution HT-2		
	Avoirdupois, U.S. Liquid	Metric
Water	24 fl oz	750 mL
KODAK 28% Acetic Acid	4 fl oz	125.0 mL
KODAK Silver Nitrate (Crystals)	1/4 ounce	7.5 grams
Water to make	32 fl oz	1.0 litre

¹To make approximately 28% acetic acid from glacial acetic acid, dilute 3 parts of glacial acetic acid with 8 parts of water.

Store the solution in a screw-cap or glass-stoppered brown bottle away from strong light. Avoid contact of test solution with the hands, clothing, negatives, prints, or undeveloped photographic materials; otherwise, black stains will ultimately result.

The KODAK Hypo Estimator consists of four color patches reproduced on a strip of transparent plastic. It is used in conjunction with KODAK Hypo Test Solution HT-2. For use in the test, an unexposed piece of film of the same type is processed with the radiographs whose fixer content is to be determined. After the test film is dried, one drop of the KODAK HT-2 Solution is placed on it and allowed to stand for 2 minutes. The excess test solution is then blotted off, and the stain on the film compared with the color patches of the KODAK Hypo Estimator. The comparison should be made on a conventional x-ray illuminator. Direct sunlight should be avoided since it will cause the spot to darken rapidly.

For commercial use, the test spot should be no darker than two thicknesses of Patch 4 of the Hypo Estimator. Two thicknesses can be obtained by folding the estimator along the center of the patch.

Storage Conditions

The residual fixer concentration for commercial use can generally be tolerated in areas where the average relative humidity and temperature in the storage space are not excessive. These quantities may, however, be excessive when storage conditions are worse than average for temperature and humidity. Archival processing should be the rule whenever it is known that relative humidity and temperature are likely to be constantly excessive, as is the case in tropical and subtropical areas.

Silver Recovery From Fixing Solutions

Silver recovery is both a significant means of conserving a natural resource and a potential source of revenue for users of radiographic products. Kodak silver recovery equipment consists of two simple, nonmoving parts: the KODAK Chemical Recovery Cartridge, Type 1-P, and the KODAK Circulating Unit, Type P. This equipment is specifically designed for the removal of silver from the overflow streams of automatically replenished processors. It is, however, equally adaptable for use with batch replenishment or hand-processing tanks. The equipment is low in cost, requires only simple nonelectrical installation, and operates at high efficiency (99 percent recovery). There is very little maintenance required.

A single cartridge is sufficient to handle the fixer overflow in almost every instance. The cartridge is connected by means of a flexible plastic tube to the fixer overflow line of a KODAK INDUSTREX Processor or to a storage tank. Simple records of the quantity of fixer and replenisher used are all that need be kept. The exhaustion point of the cartridge is determined by the use of test papers.

The KODAK Chemical Recovery Cartridge is a plastic-lined drum packed with steel wool. The steel wool is gradually dissolved by the acid in the fixer solution. The dissolved iron then replaces the silver in the silver-hypo complex. Since silver is not soluble in the acid in the fixer, it precipitates and falls to the bottom of the cartridge. This action continues until the steel wool is completely dissolved and the cartridge is exhausted.

The last statement is important: *It is the acid in the fixer solution that exhausts the cartridge*, not the amount of silver. The quantity of silver recovered can vary from 0 to 200 troy ounces (more than 13 pounds). The steel wool in a cartridge is sufficient to recover the silver in 220 gallons of fixer overflow from any KODAK INDUSTREX Processor if the fixer is replenished at the recommended rate. Occasionally, an exhausted cartridge will yield more recovered silver than expected, because once a nucleus of silver has collected, it attracts more silver. However, although a cartridge may continue to collect silver after it is exhausted, the rate of collection is lower and recoverable silver is lost; it does not pay to use an exhausted cartridge.

It is also important to note that this process depends on the fixer being acidic. This is not a problem when the overflow from an INDUSTREX Processor is passed through the cartridge, but it may be a problem if the fixer used in manual processing is treated.

Since all chemical reactions require time for completion, the flow of fixer from an automated processor should not exceed 300 mL per minute, and the flow should not exceed 300 mL per minute when batches of fixer from manual processing are treated; otherwise, the solution does not stay in the cartridge long enough for optimum recovery.

KODAK Chemical Recovery Cartridges are capable of efficiently removing the silver from 220 gallons of normally used KODAK INDUSTREX Fixer and Replenisher, or from 220 gallons of fixer prepared with KODAK X-ray Fixer and KODAK Rapid Fixer and Replenisher. If, as a result of excessive replenishment, the fixer solution has had less than normal use, the cartridges may be exhausted somewhat sooner, because the solution is more acidic and the steel wool is dissolved more rapidly. If the fixer has had more than normal use, it may be somewhat less acidic, and the cartridges would be exhausted more slowly but at a sacrifice in efficiency of silver recovery.

KODAK Silver Estimating Test Papers offer a convenient, rapid method for determining exhaustion of the cartridge, as well as providing a very rough guide for determining the concentration of silver in the solutions fed into the cartridge. The papers indicate by a change in color the approximate concentration of silver in the solution. The test strips are not sufficiently sensitive, particularly at higher concentrations of silver, to serve as a substitute for chemical analysis.

When records show that a cartridge is approaching the exhaustion point (after 100 or so gallons of fixer have been passed through it), the waste solution going to the drain should be checked periodically for silver content. Merely dip a piece of test paper into the waste solution, shake the strip to remove excess liquid, and lay it on a clean sheet of white paper. After about 15 seconds, match the color of the moistened test strip with that of one of the patches on the color chart packaged with the test papers (under regular tungsten illumination). If the test indicates that the solution contains as much as 1 gram of silver per litre (1/8 ounce per gallon), the cartridge is exhausted and should be replaced. The frequency of testing depends on the rate at which the fixer is replaced (high replenishment, several times a week). Experience has shown that because of processing variables, the test papers are a more accurate indicator of exhaustion than records of replenishment.

The approximate concentration of silver in a used solution is also determined by dipping a test strip into the solution and matching its color with that of a patch on the color chart. It is a simple matter to calculate the approximate yield of silver expected from a given quantity of solution.

In summary, use of the test papers is recommended to make sure that the cartridges are replaced at the proper time, that is, at the point of exhaustion.

KODAK Pamphlet J-9, "Silver Recovery with the KODAK Chemical Recovery Cartridge, Type P" has full details on the installation and operation of this silver-recovery system. For more information about silver recovery from used processing solutions, see KODAK Publication J-210, "Sources of Silver in Photographic Processing Facilities."

Chapter 14: Special Radiographic Techniques

"In-Motion" Radiography

In most industrial radiography, it is essential that there be no relative motion of radiation source, specimen, and film. Movement of the film with respect to the specimen results in a blurred radiograph; motion of the radiation source with respect to the specimen and film is equivalent to the use of a larger source size, resulting in increased geometric unsharpness.

There are certain cases, however, in which motion between components of the radiographic system--source, specimen, and film--has positive benefits, either economic or in producing information that could not be otherwise obtained.

Extended Specimens

An example of an extended specimen would be a longitudinal weld in a cylindrical structure. The length of the weld could be radiographed using a series of individual exposures. This would require setup time--placement and removal of films, placement of penetrameters and identification markers, and movement of tube--for each individual exposure. Economic gains can often be achieved by radiographing the entire length of the weld in a single exposure either on a strip of film or on a series of overlapping sheets.

The x-ray beam is restricted to a narrow angle by means of a diaphragm at the tube. The tube is then traversed the length of the weld (See Figure 85), each segment of weld being radiographed only during the time that the beam is incident on it. If there were two or more longitudinal welds, all could be radiographed at once using a rod-anode tube giving a 360-degree radiation beam, the radiation being restricted to a relatively thin "sheet" by lead disks concentric with the axis of the tube. In such a case, it is essential that the anode traverse along the axis of the specimen so that equal densities are obtained on the radiographs of all the welds.

Figure 85: "In-motion" radiography of long welds. Left: Single weld. Right: Simultaneous radiography of several welds, using a rod-anode tube with disk-shaped collimators.

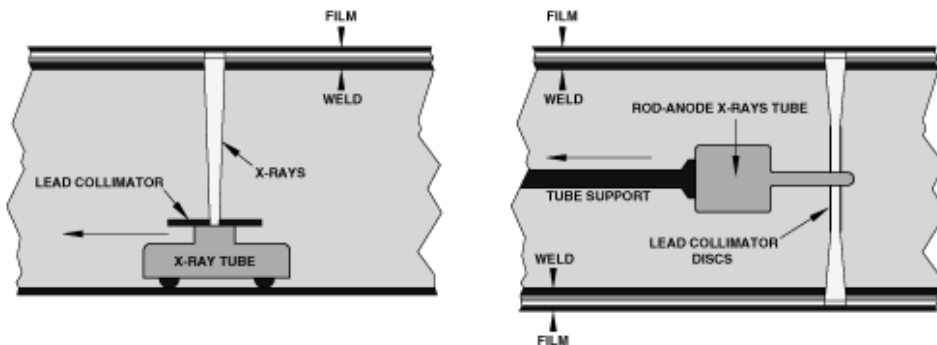

The exposure time--that is, the length of time the tube is operating--is long compared to the total exposure time for a series of individual exposures. The economic advantage arises from the very great savings in setup time, and hence in total time required for the examination.

It is for this reason, also, that the technique is applicable largely, if not entirely, to x-rays. In gamma-ray radiography, the exposure times are usually considerably longer than the setup times. The prime advantage of the method is a saving in setup time, and it is not attractive when setup time is a small part of the total. Also, the jaws required to restrict a gamma-ray beam to a

narrow angle would be very thick, especially for cobalt 60 radiation, and hence difficult to make and to position.

The technique is generally limited to thin specimens or cases where a large source-film distance can be used. The motion of the tube gives rise to a geometrical unsharpness that can be troublesome for thick specimens or short source-film distances. This unsharpness (U_m) can be calculated from the formula:

$$U_m = \frac{tw}{d}$$

where t is the thickness; w is the width of the radiation beam at the source side of the specimen, measured in the direction of motion of the tube; and d is the source-specimen distance.

If the permissible motion unsharpness can be estimated, the formula can be rearranged to give the maximum width (in the direction of motion) of the beam at the source side of the specimen:

$$w = \frac{U_m d}{t}$$

In the above formulae, distances are usually measured in inches and U_m is also in terms of inches. Thus, care must be exercised in comparing values so obtained with values of geometric unsharpness (U_g) calculated from the formula:

$$\frac{U_g}{F} = \frac{t}{D_s} \text{ or } U_g = F \left(\frac{t}{D_s} \right)$$

Because focal spot sizes are usually specified in millimetres, values of U_g , from the formula above are usually in millimetres also.

Since the exposure time T that is required for a single exposure of the specimen is usually known from experience or from an exposure chart of the material, the required rate of travel V of the tube relative to the specimen can be calculated:

$$V = \frac{w}{T}$$

where w is the width of the beam (in the direction of travel) at the source side of the specimen.

For best results with this technique, the motion of the radiation source must be smooth and uniform. Any unevenness of motion results in parallel bands of overexposure and underexposure at right angles to the direction of motion.

Rotary Radiography of Annular Specimens

Annular specimens often present economic problems if they must be radiographed in quantity. Placed flat on a film, they are wasteful of film area, of exposure and setup time, and of filing space. Great economies of time and money can be achieved by the use of a variation of the technique described above.

Film is wrapped around a circular, cylindrical, lead-covered mandrel, and covered with a light tight covering that is also rugged enough to protect the film from abrasion. Annular specimens are then slipped on the mandrel, over the film in its protective cover. Clamping means may be required to prevent rotation of the specimens with respect to the mandrel. The "loaded" mandrel is placed behind a lead shield containing a narrow slit at least as long as the mandrel (See Figure 86). During the course of the exposure, the mandrel is rotated behind the slit, each part of the specimens being radiographed in turn by the thin "sheet" of radiation passing through the slit. It is not necessary that radiography be completed in a single turn of the mechanism. Several rotations can be used but it is important that it be an integral number of turns; otherwise there will be a

band of higher or lower density on the finished radiograph. By the same token, the mandrel should rotate uniformly. Uneven rotation will cause a series of longitudinal density variations in the final record.

Figure 86: Plan of a setup for rotary radiography of annular specimens.

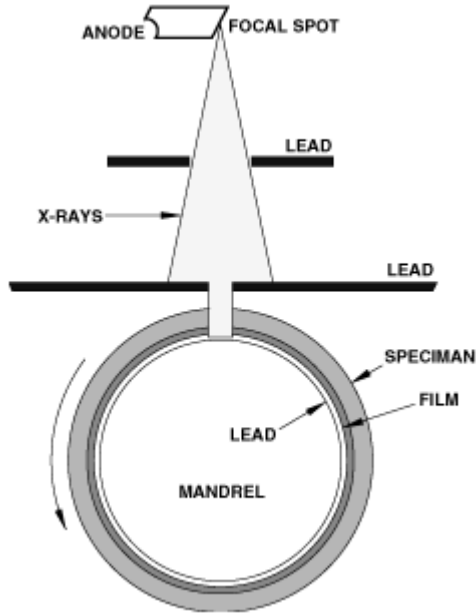

The lead shield should be comparatively thick. Any radiation transmitted by the shield will have the same effect on radiographic quality as additional scattered radiation in the same amount. A rule of thumb is that the shield should transmit, during the entire exposure, no more than a few percent of the amount of radiation received by a particular area of the film during the comparatively short time it is receiving an imaging exposure.

This form of radiography, like that described in the previous section, is also largely or entirely confined to x-radiation. With the average gamma-ray sources, exposure times would be long; the shield required would be very thick, requiring careful alignment of source and slit.

The motion unsharpness U_m to be expected can be calculated from the formula:

$$U_m = \frac{tw}{d}$$

where w here is the width of the slit in the shield.

The required peripheral velocity V_p of the mandrel can be calculated from the exposure time T for a "still" radiograph from this formula:

$$V_p = \frac{w}{T}$$

The same caution about units should be observed as described earlier.

Scanning Methods--Orthogonal Projection

Sometimes it is desirable to use scanning methods even with specimens small enough to be radiographed in their entirety in a single exposure. This is true when critical measurements of dimensions or clearances must be made from radiographs.

When radiation passes through a specimen at an angle, as shown in Figure 87 (left), spatial relationships are distorted and measurements of clearances can be significantly falsified. If, on the other hand, the whole radiograph is made with a thin "sheet" of perpendicularly directed radiation, dimensions can be measured on the radiograph with considerable accuracy (See Figure 87, right).

Figure 87: Left: Spatial relationships can be distorted in a conventional radiograph (see also Figure 12). Right: Spatial relationships are preserved by moving the specimen and film through a thin "sheet" of vertically directed radiation. (For the sake of illustrative clarity, the source-film distance is unrealistically short in relation to the specimen thickness.)

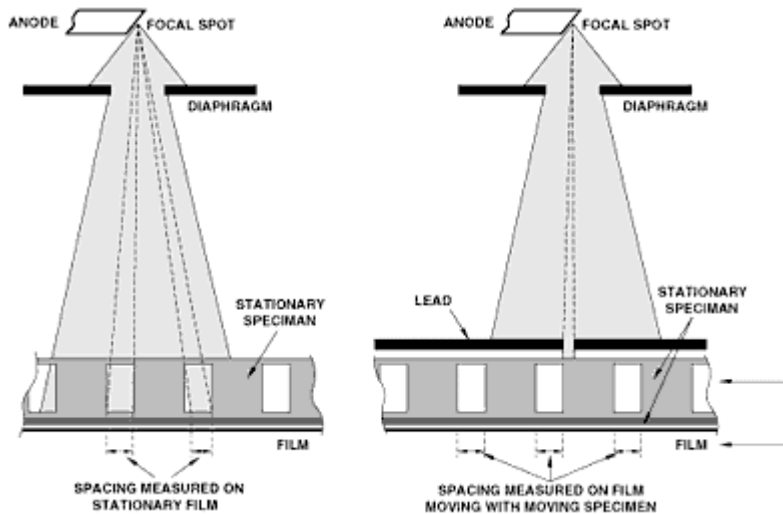

This is often most easily accomplished by moving the film and specimen beneath a narrow slit, with the x-ray tube rigidly mounted above the slit. The carriage carrying the film and specimen must move smoothly to avoid striations in the radiograph. Occasionally it is advantageous to move slit and tube over the stationary specimen and film. In general, however, this requires moving a greater weight and bulk of equipment, with the resulting increase in power required and in difficulties encountered in achieving smooth, even motion. Weight can be minimized by locating the slit near the focal spot, rather than close to the specimen. The disadvantage to this, however, is that the slit must be exceedingly narrow, very carefully machined, and precisely aligned with the central ray.

It should be recognized that this technique corrects for the errors of distance measurement shown in the figure above in only one direction--that parallel to the direction of movement of the specimen (or of tube and slit). Fortunately, most specimens to which this technique is applied are quite small, or quite long in relation to their width. If, however, the specimen is so large that measurements must be made in directions parallel to the slit (that is, at right angles to the motion) and remote from the center line, it may be necessary to scan the specimen twice in directions at right angles to one another. In a few cases, the specimen can provide its own slit. An example would be the measurement of end-to-end spacing of cylindrical uranium fuel pellets in a thin metal container. In this application, little radiation could reach the film unless it passed between the pellets almost exactly parallel to the faces of the adjacent cylinders. In such a case the slit shown in Figure 87 (right) can be comparatively wide.

Tomography

Tomography--in medical radiography, often termed "body-section radiography"--is a technique that provides a relatively distinct image of a selected plane in a specimen while the images of

structures that lie above and below that plane are blurred. It is fairly common in medical radiography, and has a few specialized applications in industrial radiography.

Figure 88: Basic principle of tomography. The source-specimen distance has been unrealistically shortened and the specimen-film distance increased, in order to show the principles of the system more clearly.

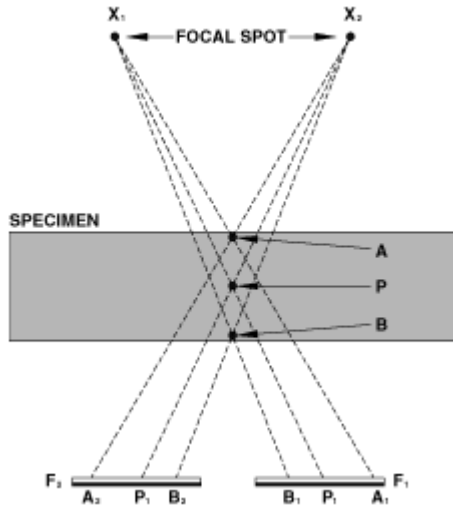

The principle can be understood by reference to Figure 88, which shows one of the simpler and more frequently used methods. The tube and film holder are linked at the ends of a lever pivoted at the level of the plane it is desired to render. The film and tube move horizontally during the course of the exposure. As the focal spot moves to the right from X_1 to X_2 and the film to the left from F_1 to F_2 , the image (P_1) of the point P remains stationary with respect to the film. However, the images of points above (A) and below (B) the point P move with respect to the film (from A_1 to A_2 and B_1 to B_2) and hence are blurred on the radiograph as shown in Figure 89.

The excursion of tube and film determines the thickness of the layer that is sharply imaged. Small motions render structures within a relatively thick section of the specimen; large motions render a thin section in sharp "focus."

Figure 88 a simple linear motion of tube and film, for the sake of illustrative clarity. In actual practice, the motions are often more complicated--circular, spiral, or hypocycloidal.

Figure 89: Demonstration of the effect obtained with tomography. The test object (below) is a series of plastic "shelves", each holding a lead letter. The first radiography (top, right) was made with conventional radiographic equipment. The second radiography (bottom, right), made with tomographic equipment, shows level C clearly, while the other levels are blurred.

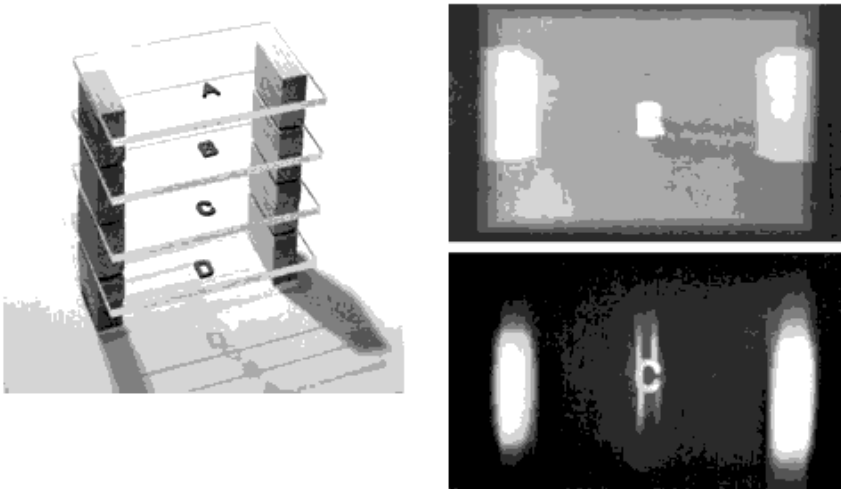

Radiography Of Radioactive Materials

Examination of radioactive materials is complicated by the fact that the film is exposed to the emission of the specimen as well as to the imaging radiation. The exposure from the specimen itself is usually uniform over the whole film area, and thus has effects similar to, and in addition to, scattered radiation from the specimen. Best radiographic results are obtained when the proportion of this "fogging" radiation to the total radiation (fogging plus imaging) affecting the film is made as small as possible.

In general, the only radiation from the specimen that needs to be considered is the gamma radiation; any beta or alpha radiation can easily be absorbed in any material between the specimen and the film. This material may be the coating, cladding, or container of the radioactive material, separate filters introduced between specimen and film, the front of the exposure holder, or any front screen used.

A number of techniques are available for minimizing the deleterious effects of the gamma radiation on the final radiograph. Which, or what combination, of these techniques is used depends on the requirements of the inspection and particularly on the activity of the specimen. As activity increases, more measures, and more complicated ones, must be employed. Because examinations of this type are highly specialized, no general directions can be given. Rather, a list of techniques, ranging from the simpler to the more expensive and complex, will be given, not all of which are necessarily applicable to every radiographic problem. It should be emphasized again that the consideration should be directed not to reducing the *absolute amount* of fogging radiation, but rather to reducing the *proportion* it bears to the imaging radiation.

Speed of Operation

The most obvious way to minimize the effect of radiation from the specimen itself is to work quickly. The film is exposed to fogging radiation during the setup, exposure, and takedown times, but to the imaging radiation only during the exposure time. It is therefore advisable that the film

and specimen be together for as little time as possible before exposure commences, and that they be separated as quickly as possible after the exposure has been completed.

Filtration

In some cases, the gamma radiation from the specimen is of longer wavelength (that is, of lower energy or softer) than the radiation used for radiography. Under these circumstances, the fogging radiation can be considerably reduced by the use of a metallic filter between specimen and film.

Often this filtration is supplied by the lead screens used, or can be provided by the use of a thicker-than-normal front screen. Under other circumstances, separate filters may be more convenient and give better results. Specific rules are difficult to formulate, and the optimum filtration is best determined experimentally under the actual radiographic conditions. More commonly, the gamma emission from the specimen is at least as penetrating as the radiographic radiation, and filtration will do no good and will probably result in a decrease of radiographic quality in the image.

Radiation Intensity

The proportion of fogging radiation to imaging radiation decreases as the intensity of the imaging radiation increases, that is, as the duration of the radiographic exposure decreases. This implies that the x-ray tube should be operated at its maximum milliamperage and that source-film distance should be as small as the requirements of image sharpness and field coverage permit. Increasing kilovoltage may result in an improvement, but this must be checked by practical tests under operating conditions. Increasing kilovoltage decreases duration of the exposure, tending to improve the radiographic quality. On the other hand, increasing kilovoltage decreases subject contrast, which is already adversely affected by the fogging radiation from the specimen itself. Which effect predominates depends on the other factors of the examination, and thus the optimum kilovoltage must be determined empirically. If gamma rays are used for radiography, the output and specific activity of the source should be as high as possible. With x-radiography of radioactive specimens, source-film distance should be the shortest that other considerations permit.

Specimen-Film Distance

Sometimes, geometric considerations of image formation allow an increase in subject-film distance. Where such is the case, radiographic contrast is improved because when a radioactive specimen is in position A (See Figure 90), some of its radiation misses the film--radiation that would affect the film in the image area if the specimen were in position B. Since the source-film distance is the same in both cases shown in Figure 90, the intensity of the image-forming radiation is unaffected. This technique results in some enlargement of the image, but often this is acceptable.

Figure 90: The amount of gamma radiation from a radioactive specimen that reaches the film depends on the subject-film distance. Much of the radiation that "misses" the film when the specimen is in position A strikes the film in the image area when the specimen is at B.

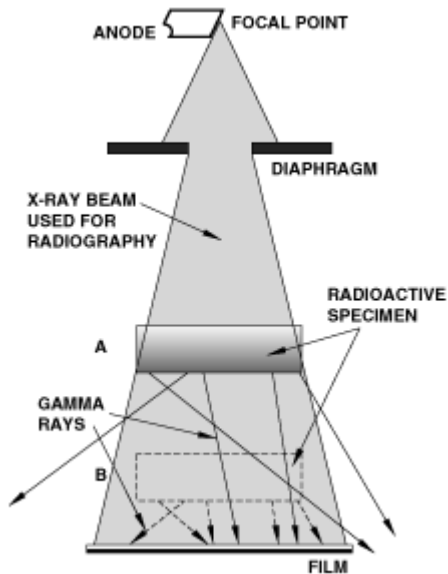

Film Speed

The use of the slowest film possible reduces the relative photographic effect of the fogging radiation from the specimen, particularly when setup and takedown times are appreciable. As these times decrease, the value to be gained from using a slower film likewise decreases.

In examinations in which the specimen emits hard gamma rays and the radiography is performed with softer radiation, the use of slower types of industrial x-ray films has a second advantage. In general, the slower x-ray films have a larger ratio of sensitivities to soft and to hard radiations. This means that, relative to their sensitivities to the softer image-forming radiation, the slower films have lower sensitivities to the hard gamma radiation from the specimen.

Slit Exposures

When radioactive materials are radiographed by conventional techniques, every point on the film receives fogging gamma radiation from every part of the specimen, throughout the whole exposure. The net effect of the fogging radiation can be reduced by putting a deep lead slit between the specimen and film, and traversing the slit and the x-ray tube together along the length of the specimen during the course of exposure (see the figure below). The net result of such an arrangement is that each area of the film receives only the fogging radiation directed vertically downward from that part of the specimen directly above it, rather than from the whole specimen. Note that the principle involved is very similar to that of the Potter-Bucky diaphragm. This method results in a very great reduction in fogging radiation and a concomitant great improvement in radiographic quality. The equipment required is often very heavy, however, since several inches of lead may be required to absorb the radiation from a highly active specimen emitting hard gamma rays. A second disadvantage is that the exposure time is considerably extended, as is the case for any scanning system of radiography. In many cases, however, this disadvantage is of minor importance compared with the value of the examination.

Figure 91: Schematic diagram of slit method for radiography of radioactive specimens.

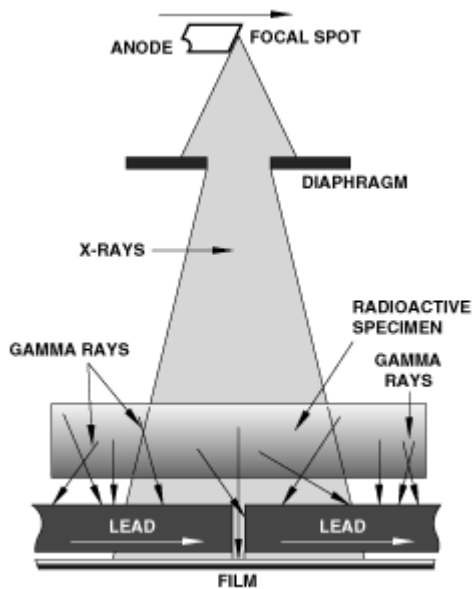

Neutron Radiography

Neutron radiography is probably one of the most effective methods for radiography of radioactive specimens. Its applications, however, are limited by the relative scarcity of suitable neutron sources and by the small cross-sectional areas of the available neutron beams. For a great discussion of the techniques of neutron radiography, see "Neutron Radiography".

Depth Localization Of Defects

Two general methods are available for determining the location in depth of a flaw within a specimen--stereoradiography and the parallax method. The chief value of stereoradiography lies in giving a vivid three-dimensional view of the subject, although with the aid of auxiliary procedures it can be used for the actual measurement of depth. The more convenient scheme for depth measurement is the parallax method in which from two exposures made with different positions of the x-ray tube, the depth of a flaw is computed from the shift of the shadow of the flaw. Although stereoradiography and the parallax method are essentially alike in principle, they are performed differently. It is therefore necessary to discuss them separately.

Stereoradiography

Objects viewed with a normal pair of eyes appear in their true perspective and in their correct spatial relation to each other, largely because of man's natural stereoscopic vision; each eye receives a slightly different view, and the two images are combined by the mental processes involved in seeing to give the impression of three dimensions.

Because a single radiographic image does not possess perspective, it cannot give the impression of depth or indicate clearly the relative positions of various parts of the object along the direction of vision. Stereoradiography, designed to overcome this deficiency of a single radiograph, requires two radiographs made from two positions of the x-ray tube, separated by the normal interpupillary distance. They are viewed in a stereoscope, a device that, by an arrangement of prisms or mirrors, permits each eye to see but a single one of the pair of stereoradiographs. As in ordinary vision, the brain fuses the two images into one in which the various parts stand out in striking relief in true perspective and in their correct spatial relation.

The radiograph exposed in the right-shift position of the x-ray tube is viewed by the right eye, and the one exposed in the left-shift position is viewed by the left eye. In fact, the conditions of viewing the radiographs should be exactly analogous to the conditions under which they were exposed; the two eyes take the place of the two positions of the focal spot of the x-ray tube, and the radiographs, as viewed in the prisms or mirrors, occupy the same position with respect to the eyes as did the films with respect to the tube during the exposures. The eyes see the x-ray representation of the part just as the x-ray tube "saw" the actual part (See Figure 92).

Figure 92: Above: Schematic diagram showing method of making stereoscopic radiographs. Below: Diagram of a stereoscopic viewer (Wheatstone type).

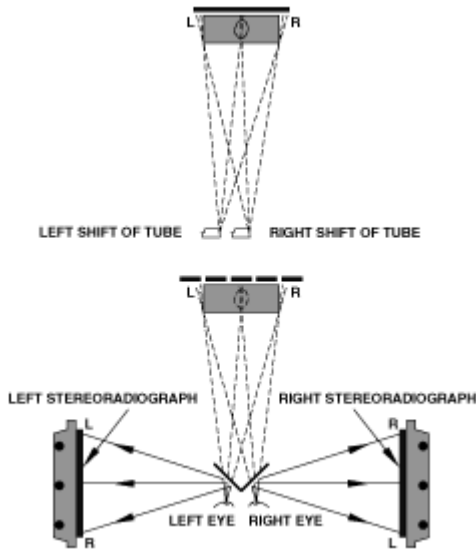

The stereoscopic impression is much more distinct if the specimen has a well-defined structure extending throughout its volume. If such a structure does not exist as, for example, in a flat plate of homogeneous material, it is necessary to provide such a structure upon one or more surfaces of the specimen. A widely spaced array of wires mounted on both front and rear surfaces of the specimen will generally suffice, or a similar pattern can be applied in the form of cross lines of lead paint. In stereoscopic radiographs, these added structures not only help to secure satisfactory register of the two films but also serve as a reference marking for the location of any details shown stereoscopically within the specimen.

The stereoscopic method is not often utilized in industrial radiography, but occasionally it can be of some value in localizing defects or in visualizing the spatial arrangement of hidden structures.

Double-Exposure (Parallax) Method

The figure below gives the details of this method. Lead markers (M_1) and (M_2) are fastened to the front and back, respectively, of the specimen. Two exposures are made, the tube being moved a known distance (a) from F_1 to F_2 between them. The position of the images of the marker (M_2) will change very little, perhaps imperceptibly, as a result of this tube shift, but the shadows of the flaw and marker (M_1) will change position by a larger amount.

Figure 93: Double-exposure (parallax) method for localizing defects.

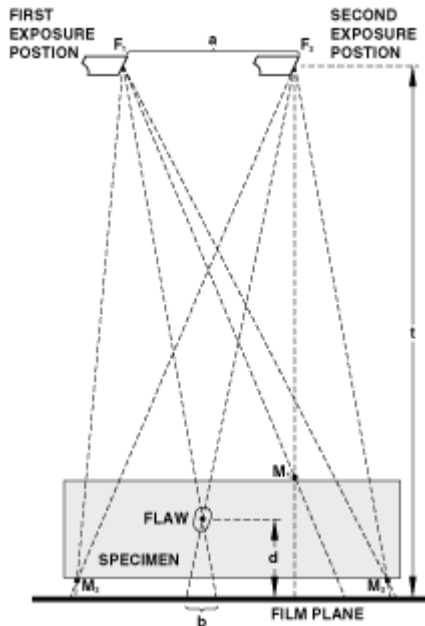

If the flaw is sufficiently prominent, both exposures may be made on the same film. (One exposure "fogs" the other, thus interfering somewhat with the visibility of detail.) The distance of the flaw above the film plane is given by the equation:

$$d = \frac{bt}{a + b}$$

where

d = distance of the flaw above the film plane,

a = tube shift,

b = change in position of flaw image, and

t = focus-film distance.

If the flaw is not sufficiently prominent to be observed easily when both exposures are made on the same film, two separate radiographs are necessary. The shadows of the marker (M_2) are superimposed and the shift of the image of the flaw is measured. The equation given in the preceding paragraph is then applied to determine the distance of the flaw from the film.

Often it is sufficient to know to which of the two surfaces of the part the flaw is nearer. In such cases, the shifts of the images of the flaw and the marker (M_1) are measured. If the shift of the image of the flaw is less than one-half that of the marker (M_1), the flaw is nearer the film plane; if greater, it is nearer the plane of the marker (M_1).

The above methods of calculation assume that the image of the bottom marker (M_2) remains essentially stationary with respect to the film. This may not always be true—for example, if the cassette or film holder is not in contact with the bottom surface of the specimen or in a situation where large tube shifts are used.

In such cases, a graphical solution is convenient. It can be shown that if the markers are placed fairly close to the flaw, the image shifts are proportional to the distances from the film plane. Thus, a straight line graph can be drawn of image shift against distance from the bottom (film side) of the specimen.

To illustrate, let us assume that the image of the bottom marker (M_2) on a specimen 2 inches thick moved $1/16$ inch and that of the top marker (M_1) moved $1/4$ inch. A graph similar to that in the figure below is drawn, with image shift on the horizontal axis and specimen thickness on the vertical. Points M_1 and M_2 are plotted at the appropriate image shift and thickness values, and a straight line is drawn between them. (Note that for convenience in plotting, 0 specimen thickness is considered to be on the film side of the specimen.) If the image of a discontinuity has shifted, for example, $3/16$ inch, its distance from the film side of the specimen-- $15/16$ inch--can be read directly from the graph as shown in the dashed line of Figure 94. It should be emphasized that Figure 94 is not a general curve, but is for illustration of the method only. A graph of the same type must be drawn for each particular set of circumstances.

Note that in this method it is not necessary to know either source-film distance or amount of tube shift. This often makes the method convenient even in those cases where the image of the bottom marker (M_2) shifts only imperceptibly. The point (M_2) of Figure 94 then coincides with the origin of the graph.

Figure 94: Example of the graphical method for localizing a discontinuity by the parallax (double-exposure) technique.

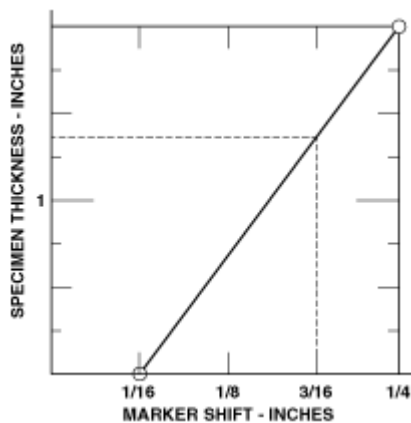

Thickness Measurement

Occasionally, it is necessary to measure the thickness of a material in a location where it is difficult or impossible to use gauges, calipers, or the like. In these cases, radiography can sometimes be applied. One example of this would be the measurement of the wall thickness of a hollow air-craft-propeller blade.

The technique is simple, involving the simultaneous radiography of the item in question and a stepped wedge of the same material. The stepped wedge should be wide or, if narrow, should be masked with lead in order to avoid difficulties and errors due to the undercut of scattered radiation into the area of the stepped wedge. The stepped wedge should be placed as close as possible to the area to be measured to avoid errors from differences in radiation intensity across the field. Ideally, the stepped wedge and the specimen should be radiographed on the same film. If this is not possible, as for instance when a film is inserted into a hollow propeller blade, the stepped wedge should be radiographed on film from the same box. Care should be taken that the screens used to radiograph specimen and wedge are the same. If separate films are used for wedge and specimen, they should be processed together. These precautions avoid errors caused by differences in x-ray exposure and errors in processing.

A curve is drawn relating thickness of the stepped wedge to the density obtained. Thicknesses in the part under test are then determined by reference to this curve. Plotting a calibration curve for

each separate radiograph may seem laborious, but it prevents invalidation of the measurement by an unnoticed or unavoidable variation in radiographic technique.

The kilovoltage used should be as low as considerations of exposure time permit, for the sake of increased subject contrast, resulting in a higher accuracy of the measurements. By the same token, radiographs should be exposed to the highest density the available densitometer can read reliably. Because the contrast of industrial x-ray films increases with density (see "The Characteristic Curve"), the accuracy of the thickness measurement likewise increases with density.

Special precautions should be observed if the specimen is narrow, or if measurements are to be made near the edges of a large specimen. In these cases, the specimen should be surrounded with a lead mask (see "Masks and Diaphragms"), to prevent the unattenuated primary radiation from striking the film near the boundaries of the specimen. Otherwise, large errors can arise in the thickness determinations.

Determination of the composition of parts is a special application of this technique. For example, it might be possible for parts identical in appearance to be made of different alloys. In general, though not invariably, different alloys have different absorptions. Thus, if a part of known composition is radiographed along with a part, or group of parts, being checked, a difference in density between corresponding areas of the control and specimens indicates a difference in composition. Note that identical densities merely make it highly probable, though not certain, that the compositions are the same. This test, of course, provides no information on heat treatment, crystal size, or the like.

It is much more difficult to estimate the size of a void or inclusion in the direction of the radiation. The density of the radiographic indication of a void depends not only on its dimensions along the direction of the beam, but also on its location within the thickness of the material and on its shape. Thus, it is necessary to prepare, by a separate experiment, calibration curves of void size versus density for each of several locations within the depth of the specimen, and perhaps for each of several shapes of void. In addition, the location of the void must be determined by one of the methods described in "Depth Localization Of Defects", in order to know which of the above-mentioned calibration curves should be used.

Such estimates of the dimensions of inclusions can be further complicated if the chemical composition and density, and hence the radiation absorption, of the inclusion is unknown.

This procedure for measuring the dimensions of voids has been applied successfully but, because of the extreme care and large amount of preliminary work required, has been limited to specimens of high value and to circumstances where all parts of the radiographic process could be kept under the most rigorous control.

High Speed Radiography

Exposure times of one-millionth of a second, or even less, can be achieved by the use of specially designed high-voltage generating equipment and x-ray tubes. Such exposure times are sufficiently short to "stop" the motion of projectiles, high-speed machinery, and the like (See Figure 95).

Figure 95: High-speed x-ray pictures of the functioning of a 20 mm HEI shell.

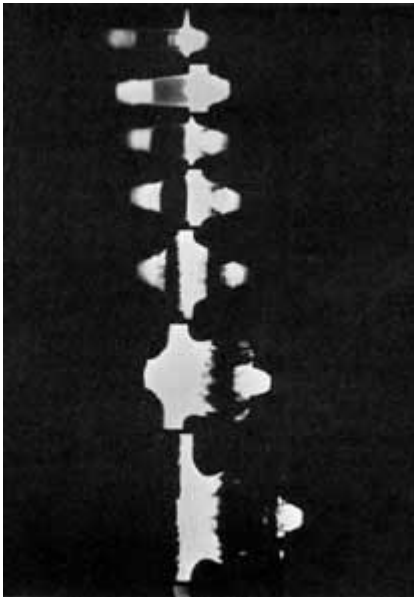

This apparatus differs from the usual industrial x-ray equipment in design of both the high-voltage generator and the x-ray tube. The generator contains large high-voltage condensers that are suddenly discharged through the x-ray tube, giving a high-voltage pulse of very short duration. The x-ray tube has a cold cathode rather than the conventional heated filament. Emission from the cold cathode is initiated by means of a third electrode placed near it. When electron emission has started, the discharge immediately transfers to the target, which is of conventional design. The tube current may reach a value as high as 2000 amperes (two million milliamperes), but because of the extremely short times of exposure, the load on the focal spot is not excessive.

Geometric Enlargement

In most radiography, it is desirable to have the specimen and the film as close together as possible to minimize geometric unsharpness (See "Calculation Of Geometric Unsharpness"). An exception to this rule occurs when the source of radiation is extremely minute, that is, a small fraction of a millimetre, as for instance in a betatron. In such a case, the film may be placed at a distance from the specimen, rather than in contact with it. (See Figure 96.) Such an arrangement results in an enlarged radiograph without introducing objectionable geometric unsharpness. Enlargements of as much as three diameters by this technique have been found to be useful in the detection of structures otherwise invisible radiographically. Geometric enlargements of several tens of times are feasible in microradiography (See "Enlargement of Microradiographs").

Figure 96: With a very small focal spot, an enlarged image can be obtained. The degree of enlargement depends on the ratio of the source-film and source-specimen distances.

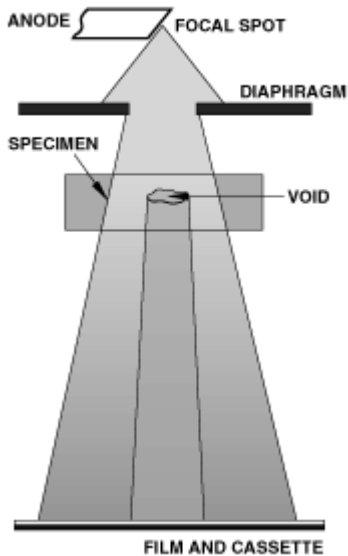

Neutron Radiography

Neutron radiography makes use of the differential absorption of neutrons--uncharged nuclear particles having about the mass of the nucleus of a hydrogen atom (proton)--rather than of electromagnetic radiation. Neutrons, in particular those traveling at very low velocities (thermal neutrons), are absorbed in matter according to laws that are very different from those that govern the absorption of x-rays and gamma rays. The absorption of x-rays and gamma rays increases as the atomic number of the absorber increases, but this is not the case with thermal neutrons. Elements having adjacent atomic numbers can have widely different absorptions, and some low atomic number elements attenuate a beam of thermal neutrons more strongly than some high atomic number elements. For example, hydrogen has a much higher neutron attenuation than does lead. Thus, the height of the water in a lead standpipe can be determined by neutron radiography--which is impossible with x-ray or gamma-ray radiography.

Neutrons, being uncharged particles, interact with matter to only a very slight degree. As a result, photographic materials are very insensitive to the direct action of neutrons and, if neutrons are to be used for imaging, some method must be used to convert their energy into a form more readily detectable photographically.

Figure 97: Two methods of neutron radiography. Top: Direct Method. Bottom: Transfer method.

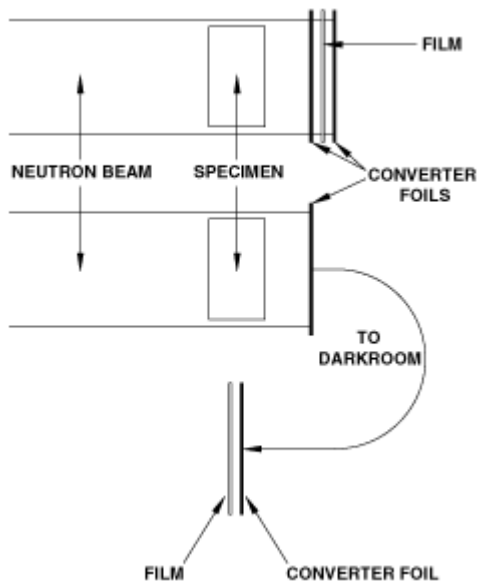

Two general classes of techniques are used in neutron radiography, both involving what are known as "converter foils". In the first--the "direct exposure" technique (See Figure 97, top)--the film is exposed between two layers of foil of a material that becomes radioactive when exposed to neutrons. The exposure to the film is caused by the beta or gamma radiation emitted by the converter foils. Foils of gadolinium, rhodium, indium, and cadmium have been used. Screens of gadolinium (0.00025-inch front, 0.002-inch back) or a front screen of 0.010-inch rhodium and a back screen of 0.002-inch gadolinium give satisfactory image quality and are among the fastest combinations.

In the second--the "transfer exposure" method (See Figure 97, bottom)--the converter foil *alone* is exposed to the neutron radiation transmitted by the specimen, and is thus rendered radioactive. After the exposure is terminated, the converter foil is placed in intimate contact with the film, and the pattern of radioactivity on the converter foil produces an imaging exposure on the film.

Converter foils of gold, indium, and dysprosium have been used in this technique. A dysprosium foil about 0.010 inch thick appears to give the highest speed, and a gold foil about 0.003 inch thick appears to give the best image quality. For efficiency, both of time and of use of the radioactivity in the foil, foil and film are kept in intimate contact for three to four half-lives of the foil activity.

Conventional industrial x-ray films are ideal for neutron radiography because the photographic material is exposed to the gamma or beta radiation from the converter foil. The relative speed values for moderately hard x-radiation are satisfactory approximations for neutron radiography.

The most satisfactory neutron source for neutron radiography is a nuclear reactor that has provisions for bringing a beam of thermal neutrons to the face of the reactor shield. Neutron intensities are high enough to permit realistically short exposure times. However, unless special arrangements are made, the beams are limited to a few inches in diameter. Thus, a large object must be radiographed in sections. A few electronic and isotopic sources of thermal neutrons are available, but these suffer from the disadvantages of low neutron intensity, large effective source size, or both.

Neutron radiography is suitable for a number of tasks impossible for conventional radiography--for example, the examination of great thicknesses of high atomic number material. Several inches of lead can be radiographed with neutrons using exposure times of a few minutes. The transfer exposure method is well adapted to the radiography of highly radioactive materials such as irradiated nuclear fuel elements. Since the converter foil is unaffected by the intense beta and gamma radiation given off by the fuel element itself, the image is formed only by the differential attenuation of the neutrons incident on the element. The disadvantages of neutron radiography are primarily associated with the comparative rarity and great cost of nuclear reactors and, to a somewhat lesser degree, the small diameter of available neutron beams.

Autoradiography

An autoradiograph is a photographic record of the radioactive material within an object, produced by putting the object in contact with a photographic material. In general, autoradiography is a laboratory process applied to microtome sections of biological tissues that contain radioisotopes, metallographic samples, and the like. Highly specialized techniques and specialized photographic materials--including liquid emulsions--are usually required.

However, certain autoradiographic techniques resemble those used in industrial radiography. Almost entirely limited to the nuclear energy field, they include the determination of the fuel distribution and of cladding uniformity of unirradiated fuel elements, and the measurement of fission-product concentration in irradiated fuel elements.

The first two applications involve comparatively low levels of radioactivity, and usually require the fastest types of x-ray film. The fuel element is placed in intimate contact with a sheet of film. The exposure time must be determined by experiment, but may be several hours. In the case of a nonuniformly loaded fuel element with uniform cladding, the densities recorded can be correlated with concentration of radioactive material in the element. In the case of a uniformly loaded plate, density can be correlated to the thickness of cladding. In either case, calibration exposures to one or more fuel elements of known properties are necessary, and ideally a calibration exposure should be processed with each batch of autoradiographic exposures.

If the nuclear fuel is unclad, a large part of the exposure to the film is caused by beta radiation. The thinnest material that gives adequate mechanical and light protection should be used between the specimen and the film. It is essential, however, that this material be exceedingly uniform in thickness. Variations in thickness will cause differences in electron transmission, and the result can easily be an "electron radiograph" of the protective material rather than a record of concentration of radioactive material in the specimen.

If the fuel element is clad, the exposure to the film is almost entirely the result of gamma radiation. Conventional exposure holders or cassettes can be used, and lead foil screens often provide substantial savings in time.

The autoradiographic determination of fission-product concentration in an irradiated fuel element usually involves exceedingly high degrees of radioactivity. The slower types of industrial x-ray film are most suitable. As in the radiography of radioactive materials, this technique places a great premium on bringing film and specimen together quickly at the start of the exposure and separating them quickly at its termination (See "Radiography Of Radioactive Materials"). As in other radiographic measurement techniques, calibration exposures or rigid control of all exposure and processing variables is needed. Some means is also usually needed to protect the film or the exposure holder from radioactive contamination during the exposure to the irradiated fuel element. Thin plastic sheeting, which can be discarded after one use, has been found suitable. This, of course, is in addition to the elaborate personnel-protection measures--beyond the scope of this publication--that are also necessary.

Duplicating Radiographs

Simultaneous Radiography

If it is known beforehand that a duplicate radiograph will be required, the easiest and most economical way of obtaining it is to expose two x-ray films of the same type simultaneously in the original exposure. Thus two essentially identical radiographs are produced at little or no extra cost in exposure time.

If lead-foil screen techniques are used, it is usually advisable to put both films between a single pair of screens. If each film is placed between a pair of screens, the absorption of the back and front screens, which separate the two films, results in a lower density on the back film. When two films are used between a single pair of screens, an increase in exposure is normally required because each film receives the intensification from only a single screen instead of from two. The exposure increase required must in most cases be determined by tests because it depends on both the kilovoltage and the specimen.

If envelope-packed film with integral lead oxide screens is used, two envelopes can be superimposed since the absorption of the lead oxide layers within the package is relatively low.

With direct exposure techniques, both films should be put into the same exposure holder, either without interleaving paper or with both sheets in the same interleaving folder. With direct exposure techniques it may sometimes be found, especially at the higher kilovoltages, that exposure time must be slightly *decreased* to achieve the same density as obtained on a single film. This is because each film acts as an intensifying screen for the other. The effect is small, but may be puzzling if unexpected.

Two or more films in factory-sealed envelopes may be exposed simultaneously. No adjustment of exposure is required because the intensifying radiation from the films is largely absorbed in the material of the envelopes.

In direct exposure techniques, if it should be necessary to use separate cardboard or plastic exposure holders for each film, care should be taken to remove any lead backing from the *front* exposure holder. The presence of the lead will cause a marked difference in density between films.

In general, observance of these rules results in two identical radiographs of equal density.

Copying Radiographs

When copies of existing radiographs are needed, they can be produced by contact printing on special duplicating film. This is a direct-positive film, which produces a duplicate-tone facsimile.

The characteristic curve of a typical duplicating film is shown in Figure 98. The negative slope indicates that increasing the exposure to light *decreases* developed density. Thus, if a sheet of this film is exposed to light through a radiograph and then processed, the dark parts of the radiograph (which transmit little light to the duplicating film) are reproduced as high densities, and the low density areas of the original are reproduced as low densities.

Figure 98: Characteristic curve of a typical film used for duplicating radiographs.

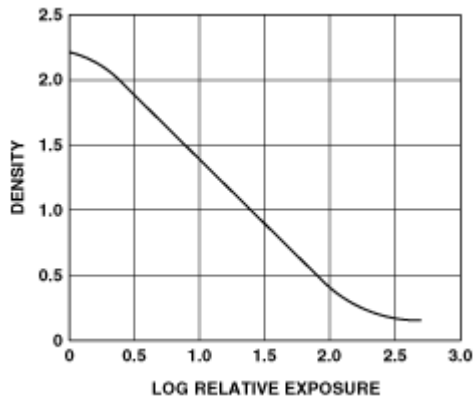

Further, the gradients of the duplicating films are -1.0 over their useful density range. This means that, within this range, density *differences* in the original radiograph are faithfully reproduced in the copy.

Exposure

The exposure technique for duplicating film is simple and may be varied to suit the equipment available. The radiograph to be copied is put in a glass-fronted printing frame (available from dealers in photographic supplies). A sheet of duplicating film is placed on top of the radiograph, emulsion side in contact with the radiograph to be copied. The back of the printing frame is closed and an exposure to light is made through the glass. Any convenient light source can be used, and thus exposure conditions are difficult to specify. However, a conventional fluorescent x-ray illuminator is a usable light source. At a distance of about 2 feet between illuminator and printing frame, exposures range from several seconds to a minute. These exposures are long enough to time conveniently with simple means yet short enough to be efficient.

When a satisfactory exposure time has been found by trial for a particular radiograph, exposures for others can be estimated much more accurately. The densities in the areas of interest of the two radiographs are read, and subtracted one from the other. The antilogarithm of this density difference is the *factor* by which the original exposure must be multiplied (if the second radiograph is darker than the first) or divided (if the second radiograph is the lighter).

Care should be taken to keep the glass front of the printing frame free from dirt, because anything opaque adhering to the glass appears as a dark mark on the processed duplicate.

Reproduction of Densities

As shown by the characteristic curve of Figure 98, the maximum density obtainable (that is, with no exposure on the duplicating film) may be below the maximum density in the radiograph to be copied. Thus, if the densities in the areas of interest in an industrial radiograph were 3.0 and 3.5, the duplicating film, the curve of which is shown in Figure 98, could not reproduce these densities. It would, however, reproduce the density *differences* exactly, and thus reproduce exactly the *radiographic contrasts* of the original. If the densities in the original were 3.0 and 3.5, these could be reproduced as 0.7 and 1.2, respectively or 1.0 and 1.5, or 1.3 and 1.8, depending on the exposure given the duplicating film.

In many cases, a reproduction of the *radiographic contrasts* alone is quite sufficient. (Note that if a radiograph with densities of 1.0 and 1.5 were displayed on an illuminator, and a similar radiograph but with densities of 3.0 and 3.5 were displayed on an illuminator 100 times as bright, an observer would be unable to distinguish between them.)

Sometimes, as when sets of reference radiographs are being prepared, it is required to reproduce both the densities and the density differences of the original. This can be done by mounting a uniform density filter behind the copy. In the example cited above, the densities of the original were 3.0 and 3.5, and the densities of the copy were 1.0 and 1.5. If a uniform density of 2.0 is added, the total densities will be raised to 3.0 and 3.5, just as in the original.

The least expensive and most convenient neutral density filter is a processed sheet of fine-grained photographic film which has been uniformly exposed to light. This film should be coated on clear base, so that the color of the copy is not changed. Further, the film chosen should be very slow so that exposure is easy to control. Ideally, it should also be sensitive only to the blue portion of the visible spectrum and may be handled under the safelighting conditions used for x-ray films.

In assembling copies and neutral density filters, the duplicating film and the neutral density filter should be positioned so that their emulsion sides are toward the viewer.

Fluoroscopy

Fluoroscopy differs from radiography in that the x-ray image is observed virtually on a fluorescent screen rather than recorded on a film. A diagrammatic sketch of an industrial fluoroscopic unit is shown in Figure 99.

Figure 99: Schematic diagram of an industrial fluoroscope. Commercial models may differ from the illustration. For more rapid examinations, industrial fluoroscopes may be provided with material conveyors.

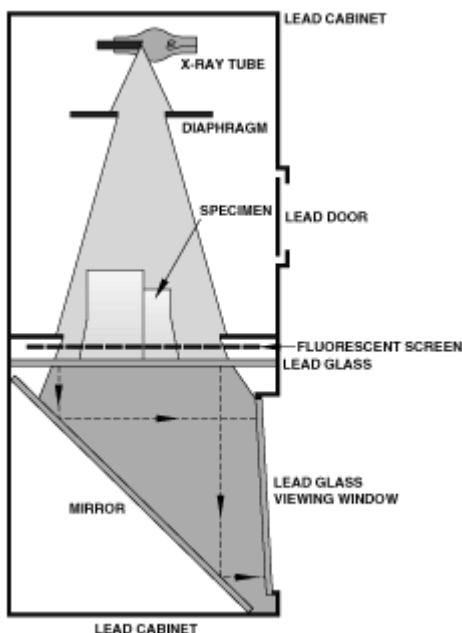

Fluoroscopy has the advantages of high speed and low cost.

However, fluoroscopy has three limitations: (1) Examination of thick, dense, or high-atomic-number specimens is impractical, because the x-ray intensities passing through them are too low to give a sufficiently bright image on the fluorescent screen. (2) The sensitivity of the fluoroscopic process is not as great as that of radiography. This is caused in part by the lower contrast and coarser grain of the fluoroscopic screen as compared to the film record, and in part by the

relatively short source-screen distances that must be used to obtain high screen brightnesses. This latter factor also increases the distortion of the fluoroscopic image. (3) The lack of a permanent record of the examination may be a further disadvantage.

The main application for fluoroscopy is in the rapid examination of light, easily penetrated articles, the unit value of which does not warrant the expense of radiography, or of items for which a highly sensitive test is unnecessary. Fluoroscopy has been used, for example, in the inspection of packaged foods for foreign objects and of molded plastic parts for the correct placement of metallic inserts. In some cases, it is advantageous to sort parts fluoroscopically before they are radiographed to save the expense of radiographing specimens that contain gross flaws.

Figure 100: Schematic diagram of a fluoroscopic image intensifier.

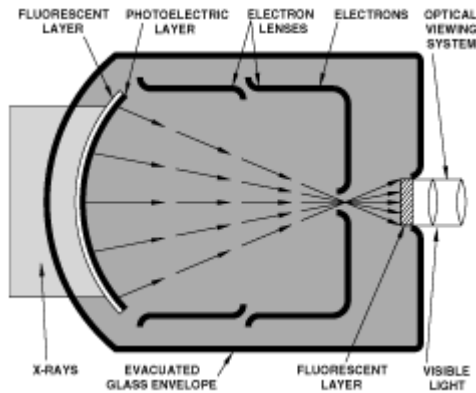

An extension of fluoroscopy involves the use of image intensifiers (See Figure 100). In these, the x-rays, after traversing the specimen, strike a fluorescent screen (the "input phosphor"). The fluorescence of the screen causes the photoelectric surface with which it is coated to emit electrons in proportion to the intensity of the fluorescence. These electrons are accelerated and focused by electrostatic lenses onto a second fluoroscopic screen (the "output phosphor") much smaller than the first. The second phosphor has a brightness several hundreds of times that of the first, partly because of its smaller size and partly because of the additional energy imparted to the electrons by the accelerating voltage in the image intensifier. The second phosphor can be viewed directly by means of a suitable optical system. Alternatively, the image on the output phosphor may be picked up by a television camera and displayed on a television monitor at any convenient location. The use of a television link permits the brightness and the contrast of the final image to be adjusted independently of any radiographic variables. The use of image intensifiers where they are applicable avoids many of the visual difficulties attributable to low screen brightness.

In a third method which may be classified as fluoroscopy, the functions of image intensifier and television camera are combined. The sensing element is an x-ray-sensitive television pickup tube, the output from which is fed through a video amplifier to one or more television monitors at remote locations. The sensitive areas of the pickup tubes are often rather small, making the system applicable only to the examination of small items such as electronic components or spot welds, or of narrow subjects such as longitudinal welds in thin materials. On the other hand, the small size of the x-ray-sensitive area, coupled with the fairly large size of the television display, results in a direct magnification of the image that may be as great as 30 diameters. With this equipment as well, brightness and contrast of the final image can be adjusted electronically.

Photofluorography

In photofluorography (See Figure 101) the image on the fluorescent screen is photographed with a camera on small or even miniature film rather than viewed directly. In medicine, the economy of this procedure has made it useful in the examination of large groups of people for disease of the chest. In rendition of detail, photofluorography is superior to fluoroscopy because the film can be viewed with ample illumination; the photon exposure can be integrated to a high exposure level; and the photographic process enhances the contrast of the fluorescent image on the screen.

Figure 101: Schematic diagram of an industrial photofluorographic unit. Details of commercial units may differ from this illustration.

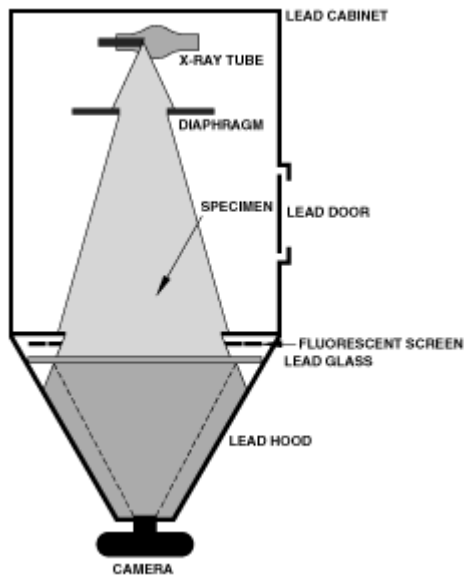

Compared to full-sized radiography, the factors that diminish detail in the miniature photoradiograph are the graininess and diffusion in the fluorescent screen, the limitations of the lens in definition, and the relatively greater influence of film graininess in the small image. Since requirements of medical and industrial radiography are not the same, photofluorographic units for each application may be expected to differ from one another in many details. In the industrial field, photofluorography has been used for the inspection of parts for which the sensitivity requirements are not severe, and where the value of the part is too low to permit the expense of conventional radiography.

A modification of photofluorography is cinefluorography--the production of x-ray motion pictures. In the simplest form of cinefluorography, the still camera shown in the figure above is replaced by a motion-picture camera. This form of the technique is limited to relatively thin specimens, to low frame rates, or to both, because the available fluorescent-screen brightness is restricted by the permissible x-ray tube loads. Cinefluorography can be extended to thicker specimens or higher frame rates by the use of an image intensifier in place of the simple fluoroscopic screen. Cinefluorography is essentially a research tool, and as a consequence the details of the apparatus depend very strongly on the requirements of the particular investigation.

Microradiography

Sometimes--usually with thin specimens of low x-ray absorption--the detail required for study is too fine to be seen with the naked eye, and examination of the image through a low powered microscope or enlargement of the radiograph by ordinary optical projection, is required to visualize the available detail. This method, *microradiography*, generally employs soft x-rays generated in the range of 5 to 50 kV. The photographic emulsion is usually single coated and finer grained than the emulsion of ordinary x-ray films.

Commercial applications of microradiography have included such unrelated projects as studying cemented joints in corrugated cardboard, and distinguishing between natural and cultured pearls. Biological materials, such as tissue sections, insects, and seeds, have been examined. In horticulture, the distribution of inorganic spray materials on foliage has been investigated by means of microradiography. Of particular interest to the metallurgist is the demonstration of minute discontinuities and the segregation of the constituents of an alloy in a thin section (See Figure 102).

Figure 102: Microradiograph of leaded brass made on a very slow photographic plate of low graininess. Enlargement is about 150 diameters.

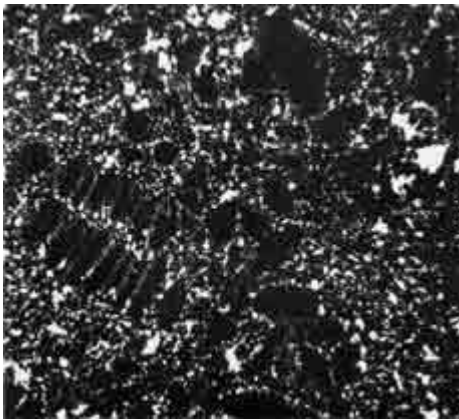
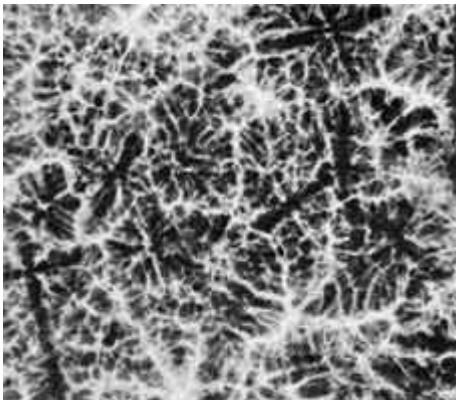

Figure 103: Microradiograph of a cast aluminum alloy containing about 8 percent copper, made on a slow photographic plate of low graininess. Light areas are copper-rich. Enlargement is 35 diameters.



Both the continuous, or "white", x-radiation and the characteristic K spectrum from a suitable target find use in microradiography. The continuous spectrum can be used for detection of minute

discontinuities or of segregation in alloys in which the components differ fairly widely in atomic number—for example, the examination of aluminum copper alloys (See Figure 103), or in the determination of the dispersion of lead in a leaded brass. For such applications, tungsten-target, beryllium-window tubes operating up to 50 kV are useful. The continuous spectrum from x-ray diffraction tubes can also be used. Microradiography has also been accomplished using the white radiation from ordinary radiographic tubes operated at a low voltage, although the x-ray intensity obtained at low voltages is severely limited by the thickness of the tube window.

When segregation of components that do not differ greatly in atomic number must be detected, the use of the characteristic K x-ray spectrum from a suitable element gives the best results. K characteristic radiation can be obtained by two methods. An x-ray tube with a target of the suitable material has the advantage of a relatively high intensity of K radiation, but has the disadvantage of requiring several x-ray tubes of different target materials or a tube with demountable targets. In addition, a number of elements that emit K radiation that might be useful cannot be made into x-ray tube targets. Use of K fluorescence radiation, obtained by irradiating a secondary target of a suitable material with the intense continuous spectrum of a tungsten-target tube avoids the disadvantage of the first method and gives a nearly pure K spectrum. However, the intensities available by this method are relatively low and long exposure times are needed.

Extremely good contact between specimen and film is necessary if the maximum enlargement of which the film is capable is to be achieved. Good contact can be obtained with a simple mechanical jig that presses the specimen against the film or plate, but best results are probably obtained with a vacuum exposure holder. This consists of a plate with a milled recess into which the photographic material and specimen are placed and over which is put a flexible transparent cover. Evacuation of the recess with a vacuum pump or water aspirator causes the atmospheric pressure on the cover to press the specimen into intimate contact with the film or plate. (See Figure 104)

Figure 104: Arrangement for microradiography using a vacuum exposure holder. The specimen thickness has been exaggerated for the sake of illustrative clarity.

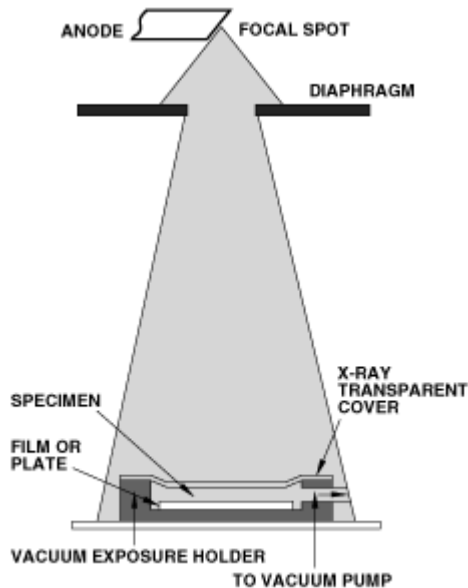

Any material placed between tube and specimen must be thin and of low atomic number (for example, a thin sheet of cellulose derivative) to minimize x-ray absorption, and must have no marked structure. Certain sheet plastic materials contain chlorine. These should not be used as

covers for microradiographic film holders because their absorption for soft x-rays is likely to be high.

The source-film distance usually ranges from 3 to 12 inches. The choice of tube voltage or K-emitting element must be based on the character of the specimen and may be quite critical if the finest radiographic results are to be obtained from a particular specimen. The type of film or plate must be selected to meet the degree of magnification to be used in examining the radiograph.

It is of little value to specify exact exposure techniques in microradiography, but the following example may serve as a useful guide: Specimen, plate of aluminum-base alloy 1/4 mm thick; exposure, 20 kV, 25 mA, 12-inch source-film distance; time, 1 1/2 minutes using the slowest available industrial x-ray film.

Because of the relatively high absorption by air of the very soft x-radiation used in microradiography, the x-ray intensity decreases with distance from the focal spot more rapidly than calculations based on the inverse square law would indicate (See "Milliamperage-Distance Relation").

In conventional microradiography, the specimen and film must be in close contact because the subsequent optical enlargement of the radiograph demands that geometric unsharpness (See "Calculation Of Geometric Unsharpness") be minimized. By the use of special x-ray tubes having focal spots about 1 micron (0.00004 inch) in diameter, the source-specimen distance may be made very small and the specimen-film distance some tens of times greater. This results in a geometric enlargement in the original microradiograph that can often be viewed directly without any intervening optical or photographic steps.

Enlargement of Microradiographs

If a microradiograph must be enlarged more than 50 diameters, conventional photomicrographic techniques and equipment must be used. However, it is seldom necessary to enlarge industrial microradiographs more than 50 diameters. Such enlargements may be prepared by a technique known as photomacrography. The term *photomacrography* refers to enlargements of about 50 diameters or less, made with a single lens, as opposed to photomicrography, which implies greater enlargements using a compound microscope. Photomacrographic equipment is relatively inexpensive, and is often readily available in plant photographic departments.

Lenses and Cameras

The simplest method obtaining moderate enlargements of microradiographs, and one that frequently gives satisfactory results, is to use a conventional photographic enlarger. A microfilm enlarger embodying a "point source" of light and condenser illumination is preferred, but any photographic enlarger of good quality may be used. The microradiograph is placed in the negative carrier of the enlarger and a sheet of photographic paper or film is placed on the easel. As in all photographic enlarging, it is important that the enlarger be rigid; if the negative carrier of the enlarger vibrates with respect to the easel during the exposure, the enlarged image will be blurred.

For enlargements up to 50 diameters, best results are obtained if the specialized equipment--cameras, lenses, and specimen holders--available for photomacrography is employed. Several optical manufacturers make lenses specially for this purpose. View cameras or those specially designed for enlarged-image photography are most convenient, although an enlarger with a film adapter back can also be used.

In addition, short focal-length camera or enlarger lenses can be employed if they are used "backward"--that is, with the front of the lens toward the film in the camera and the back of the lens toward the microradiograph being reproduced. The disadvantage of using these lenses is that the aperture settings are inside the camera and can be changed only by removing the lens

from the camera or by reaching down the bellows. This disadvantage may be outweighed by the easy availability of the lenses.

When a lens of 16 mm focal length is used, a 50-diameter enlargement requires a lens-to-film distance of about 32 inches. Longer focal-length lenses require greater bellows extension on the camera for the same enlargement. Lower magnifications can be obtained either by reducing the lens-to-film distance, or by using a lens of a different focal length.

A properly focused condenser lens is preferred for illuminating the microradiograph. Ideally, the condenser lens should be chosen to suit the camera lens being used. The illumination is properly adjusted when an image of the lamp filament is in focus on the diaphragm leaves of the camera lens, and slightly larger in size than the camera-lens aperture that will be used when making the enlargement. A setup for photomacrography is illustrated in the figure below. A heat-absorbing filter must be used to prevent buckling of the microradiograph.

Figure 105: Optical arrangement for photomacrography.

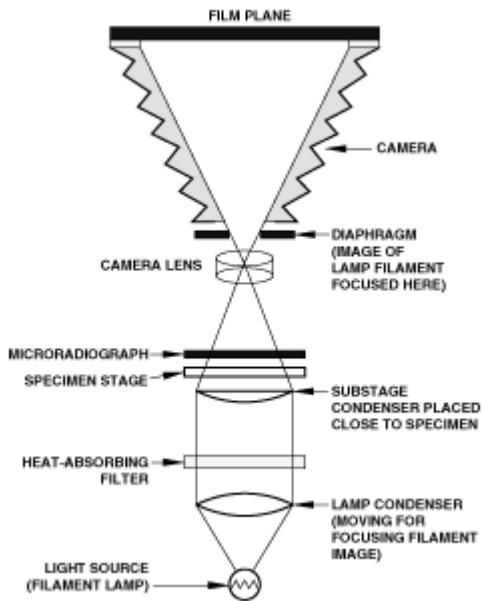

If a specimen stage (specimen holder) and condenser lens are not available, the microradiograph may be placed on opal glass or ground glass and illuminated from behind. Opal glass is preferable to ground glass, but both cause some loss in image quality, particularly at the greater magnifications. Because diffuse illumination of the microradiograph wastes a great deal of light compared to condenser illumination, exposure times can be as much as 20 times longer than with condenser illumination. In addition, the camera image, being dim, is much more difficult to focus accurately.

Photographic Films and Papers

The enlarged reproduction of the microradiograph may be either a positive (tone scale reversed from that of the original) or a negative (tone scale the same as that of the original). The choice depends on the use to be made of the enlargement and, in some cases, on the density scale of the original microradiograph.

Positive enlargements are simpler to make than are negative enlargements because they involve the minimum number of photographic steps. For low magnifications, they are also quicker, provided that only one or two enlargements of each microradiograph are needed. However, many microradiographs contain too great a range of densities to be reproduced satisfactorily in a single

photographic step. The useful scale of photographic papers is much less than that of microradiographic films or plates. Hence, if a microradiograph containing a wide range of densities is projected directly onto a photographic paper, details may be lost in either the high or low density areas or in both. Thus, direct printing is only useful for microradiographs of relatively low contrast. A density difference of about 1.2 to 1.4 between the highest and lowest densities of interest in the microradiograph is about the maximum density scale that can be accommodated by the lowest contrast photographic enlarging paper (Grade 1). Microradiographs with lower density scale can be printed on papers of higher contrast as shown in the table below.

Paper Grades for Reproduction of Microradiographs

Enlarging Paper Grade Number	Density Scale of Microradiograph or Intermediate
1	1.2 to 1.4
2	1.0 to 1.2
3	0.8 to 1.0
4	0.6 to 0.8
5	below 0.6

The densities of very small areas on microradiographs may be difficult or even impossible to measure with the result that trial exposures on several grades of paper may be necessary. The criterion, whether the grade of paper is chosen from the table or by trial and error, is that the densities in the area of interest in the microradiograph just "fill up" the exposure scale of the paper.

Often, the density scale of interest in the microradiograph is greater than 1.4, or a duplicate-tone reproduction is required, or many copies of the enlarged microradiograph are needed. It is then necessary to make an intermediate copy on film at the desired magnification, and to contact-print this intermediate on a suitable grade of paper.

Because of the wide range of densities in most microradiographs, a low-contrast intermediate is usually necessary. A fine grained sheet film of the type used for portraiture, developed to a gamma of about 0.4, is generally satisfactory.

By contact printing this intermediate, copies of the microradiograph can be conveniently produced in any desired quantity. The grade of paper to use with any intermediate can be chosen from Table VII or by trials with several grades of paper. Grade 0 is available as a contact-printing paper, and will satisfactorily reproduce intermediates where the density range is 1.4 to 1.6. Loss of significant detail can result if some areas on the paper print are overexposed to a uniform black and/or others so underexposed that they present a uniform white. Fitting the paper grade to the area of interest in the intermediate insures that significant details appear with the maximum contrast, but without loss of "highlight" or "shadow" detail.

Electron Radiography

In electron radiography, electrons emitted by lead foil irradiated by x-rays pass through a thin specimen of low atomic number. They are differentially absorbed in their passage and record the structure specimen on a film (See Figure 106).

Figure 106: Schematic diagram of the technique for making electron radiographs. More electrons can reach the film through the thin portions of the specimen than through the thick portions. (For illustrative clarity, the electron paths have been shown as straight and parallel; actually, the electrons are emitted diffusely.)

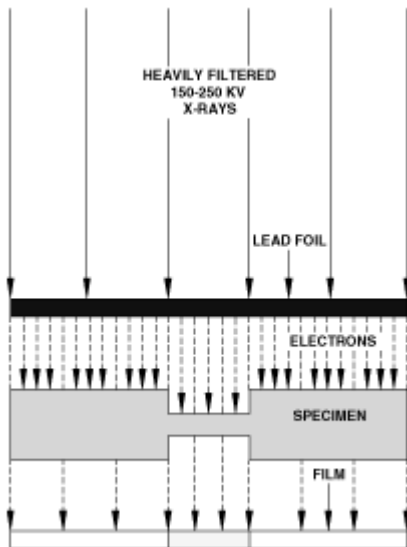

Specimens that can be examined by electron radiography are limited by the range of the electrons to thin, light materials. Papers, wood shavings, leaves, fabrics, and thin sheets of rubber and plastic have been examined by this method.

A conventional front lead foil screen, 0.005 inch thick, is a suitable source of electrons. The x-rays should be generated at the highest kilovoltage, up to at least 250 kV and a filter equivalent to several millimetres of copper should be placed in the tube port. The very hard x-radiation is needed because the electron emission of lead foil screens increases with increasing hardness of radiation, up to several hundred kilovolts. In other words, as the penetration of the radiation increases, the photographic effect of the electrons from the lead foil screens becomes greater relative to the photographic effect of the direct x-rays. In electron radiography, the useful image is formed only by electron action, and the direct x-rays act only to produce a uniform overall exposure. It is therefore desirable to minimize the relative intensity of the contrast-reducing direct radiation by achieving the highest electron emission--that is, the highest intensification factor--possible.

The slowest industrial x-ray films are most suitable for electron radiography. When the film used is double-coated, it is desirable to protect the back emulsion from the action of the developer or to remove it after processing (See "Removal Of One Emulsion From Double-Coated Film") because this emulsion contains no image, only the uniform density resulting from direct x-ray exposure.

Maximum enlargements feasible in electron radiography are much lower than those possible in microradiography with the same film. This is because the electrons are strongly diffused in the specimen, and also because film graininess increases markedly in going from the voltages used in microradiography to the high energy x-ray and electron exposures used in electron radiography (See "Film Graininess, Screen Mottle" and "Signal-To-Noise Ratio").

Good contact between lead foil, specimen, and film is essential. The electron emission from lead foil is diffuse, and the electrons are further diffused as they pass through the specimen. Therefore, any space between foil, specimen, and film results in great deterioration in image sharpness (See Figure 27). A vacuum cassette (as discussed in "Microradiography") should be used whenever possible or, lacking this, screen, specimen, and film should be clamped in

intimate contact. In particular, the pressure supplied by a conventional spring-backed cassette may be insufficient to produce adequate contact if the specimen--for instance, a leaf or a wrinkled piece of stiff paper--is not itself flat.

A method related to electron radiography is electron-emission radiography--sometimes referred to in Europe as "reflection microradiography." This method is based on the fact that electron emission from a substance exposed to x-rays depends on the atomic number of the material, among other factors. When a photographic or radiographic film is placed in intimate contact with a specimen and the whole irradiated from the film side with hard x-rays such as are used in electron radiography, differences in electron emission resulting from differences in atomic number and variations in concentration of components are recorded on the developed film, as is shown in Figure 107.

Figure 107: Schematic diagram of the technique for making electron-emission radiographs. More electrons are emitted from the areas of the specimen that contain materials of high atomic number. (For illustrative clarity, the electron paths have been shown as straight and parallel; actually, the electrons are emitted diffusely.)

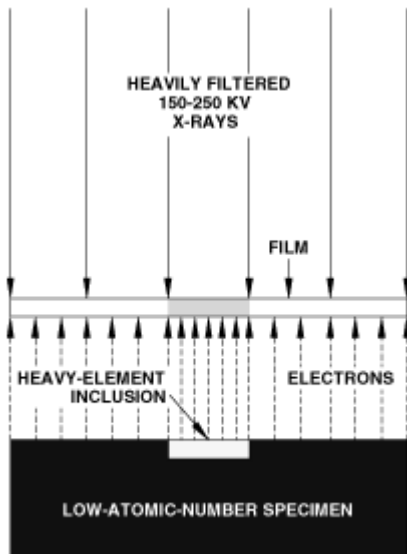

Hard x-rays are required in this technique for the same reason as in electron radiography: It is necessary to maximize the ratio between the electron exposure, which produces the image, and the uniform overall exposure produced by the direct x-rays.

Specimens to be examined by electron-emission radiography need to be smooth and plane on one side only and can be quite massive--significant factors when the specimen cannot be cut.

An electron-emission radiograph resembles a photomicrograph in that it shows details only of the surface of a specimen whereas microradiography shows the distribution of a component throughout the thickness of the specimen. For this reason, and because electron emission is less sensitive to differences in atomic number than is soft x-ray absorption, an electron-emission radiograph of a specimen contains markedly less information than a microradiograph of a thin section of the same specimen.

Image definition is also poorer than in a microradiograph because of the diffuse emission of electrons from the surface and because of the increased graininess of the film associated with the high-energy x-ray and electron exposures. Nevertheless, electron-emission radiography is a

valuable technique, for instance, in the examination of printed matter to distinguish nondestructively between inks containing metallic pigments and those containing aniline dyes.

The photographic materials used for microradiography are also useful for electron-emission radiography. However, the maximum enlargements possible are considerably less than those attained in microradiography with the same film because of the diffuse nature of the electron emission and the greater graininess. As in the case of electron radiography, the back emulsion of a double-coated film should be protected from the action of the developer or it should be removed after processing (See "Removal Of One Emulsion From Double-Coated Film").

It is necessary to insure good contact between specimen and film because of the diffuse emission of the electrons that produce the image. In the case of small specimens, a vacuum cassette, into which both specimen and film can be put, is very useful.

Figure 108: Bavarian stamp of 1920 (Scott No. O52). A: Photograph. The design is green and the "Deutsches Reich" overprint is black. B: Soft x-ray radiograph. Details of both design and paper are visible. Design is "negative," indicating absorption of the x-rays by the ink. C: Electron radiograph. Only the details of the paper are shown. D: Electron-emission radiograph. The design is "positive," indicating a relatively high electron emission from some heavy element in the ink. The overprint cannot be seen.

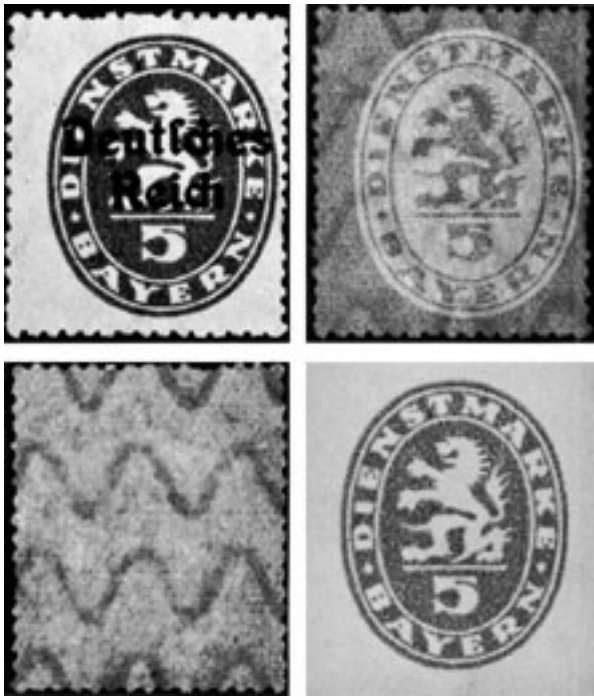

The three techniques--soft x-ray radiography (microradiography), electron radiography, and electron-emission radiography--can be compared using the postage stamp (See Figure 108A) as a specimen. The design of the stamp is green and the "Deutsches Reich" overprint is black. Figure 108B above is a soft x-ray radiograph, which could be greatly enlarged if necessary, showing details of both design and paper. The image of the design is a negative indicating the absorption of the x-radiation by the ink. The electron radiograph (See Figure 108C) was made with the design of the stamp away from the recording film, and contains details of the paper structure only. The "wavy line" watermark shows very clearly. The electron-emission radiograph (See Figure 108D) shows the details of the design alone, indicating that the green ink has a high electron emission and hence that it contains a metallic pigment, rather than aniline dye. No trace of the black overprint is visible because the carbon-based ink has negligible electron emission.

Note: It is unlawful to make radiographs of stamps of the United States of America or other countries without specific authorization from the Chief of the U.S. Secret Service, Washington, D.C. This permission has been received.

X-Ray Diffraction

This application of x-rays has nothing in common with the shadow picture method ordinarily referred to as radiography. It is of considerable value, however, in the industrial laboratory, for by its use compounds can be identified, crystalline structures determined, and the effect on metals of cold work and annealing studied.

A crystal is made up of a definite geometric arrangement of atoms, and the regular planes thus established are capable of diffracting x-rays. In this process of diffraction, the x-rays are deflected in different directions and form a pattern on film, the character of this pattern being determined by the arrangements of atoms and tiny crystals in the specimen. If a change is brought about in the crystalline state of the material, by heat treatment, for example, the change will be registered in the pattern. X-ray diffraction is useful in pure research as well as in manufacturing process controls.

Figure 109: Schematic diagram of x-ray diffraction methods. A: The Laue method uses heterogeneous radiation and a stationary crystal. In the Bragg method, the crystal is rotated or oscillated and monochromatic radiation is used. B: Debye-Scherrer-Hull (powder) method. C: Back-reflection method.

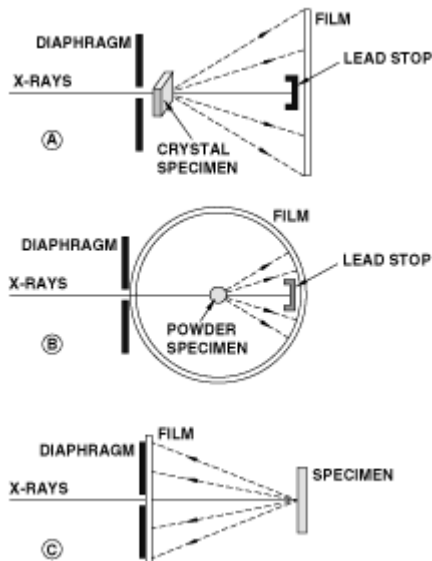

In the Laue method, a narrow beam of x-rays (See Figure 109A) from the continuous spectrum passes through a single crystal of the material under investigation. The primary beam should be stopped at the film with a small piece of lead to prevent scattered x-rays from fogging the film. Some of the x-rays are diffracted, but only in particular directions, and the places where these rays impinge show as more or less dense spots on the developed film (See Figure 110).

Figure 110: X-ray diffraction pattern of the mineral beryl (beryllium aluminum silicate) made by the Laue method, illustrated in Figure 109A).

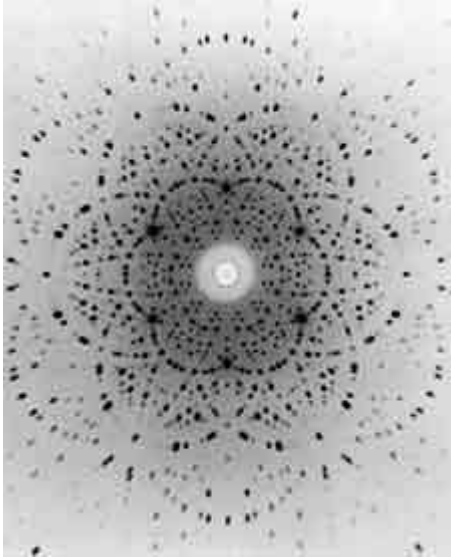

The position of the spots is determined by Bragg's Law, namely, $n\lambda = 2d \sin \theta$ where n is the order of the spectrum, λ the wavelength of the x-rays, d the distance between the atomic planes involved, and θ the angle between the diffracted x-ray and the atomic plane. Because a crystal is a regular arrangement of atoms in space, there are many planes at different angles, just as there are many different rows of trees with different spacings in an orchard, depending on the angle at which the orchard is viewed. If the crystal is properly oriented and suitably rotated or oscillated (Bragg's method), and the x-rays used are monoenergetic, the information thus obtained is particularly useful for the determination of the internal structures of crystals (See Figure 111).

Figure 111: X-ray diffraction pattern of silver oxalate ($\text{Ag}_2\text{C}_2\text{O}_4$) made by the rotating crystal method, illustrated Figure 11A.

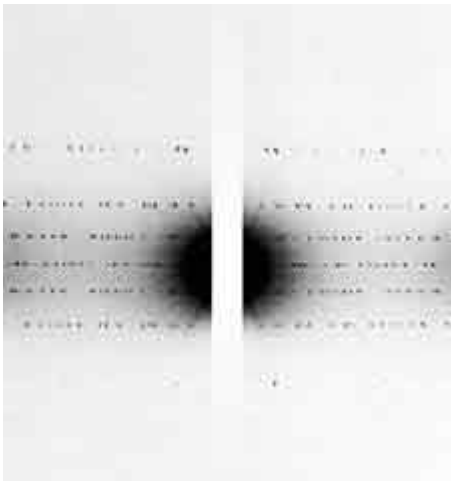

Besides certain technical limitations of the Laue method, the necessity for always having a single crystal available is a handicap. The Debye-Scherrer-Hull method (See Figure 109B) commonly utilizes a small amount of the sample in powdered form packed in a fine glass capillary, or stuck to a fiber or flat ribbon of material transparent to the x-rays. The resulting random distribution of tiny crystals permits Bragg's Law to be satisfied for many different lattice planes within the crystal. In this system, monoenergetic x-rays are used. Determination of crystal lattice constants can be made by the Debye-Scherrer-Hull method (Figure 112).

Figure 112: Powder diffraction patterns by the Debye-Scherrer-Hull method. Top: Sodium chloride (common salt) (Na_2Cl). Bottom: Sodium sulphate, anhydrous (Na_2SO_4).

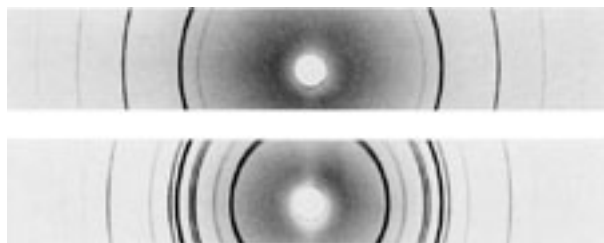

Some indication of the size of the crystals of the powder can be derived from the character of the diffraction lines. The method also applies to the study of metallurgical samples in the form of foil, since these are, in general, polycrystalline. If the specimen is sufficiently transparent to the x-rays, the arrangement in Figure 109B in a previous figure may be used; but, if it is too thick, the rays diffracted backward would be used, as in Figure 109C in the same figure. In this way information is derived about mechanical strains and preferred orientations in the specimen, and about the relation between these indications and the nature and amount of heat treatment or of mechanical working.

Films for X-ray Diffraction

The choice of a film for a particular problem depends on the radiation quality and the relative importance of film speed, contrast, and graininess.

Since the parallax associated with an image on double-coated film may be objectionable in certain applications of x-ray diffraction, a single-coated film may be preferable. However, if a double-coated film is used, one emulsion can be protected against the action of the developer by a waterproof tape, which is removed after the film is in the fixer. Alternatively the emulsion may be removed from one side of the completely processed film. Methods of applying both these techniques are described in "Removal Of One Emulsion From Double-Coated Film".

Often the location, rather than the intensity, of lines or spots of x-ray diffraction patterns is of importance. Under these circumstances, considerable savings in exposure time can be achieved by the chemical aftertreatment known as intensification, described in "Intensification Of Underexposed Radiographs".

X-ray Diffraction References

Amoros, Jose L., Buerger, Martin J., And Amoros, Marisa C. - The Laue Method, Academic Press, New York, San Francisco, London, 1975.

Azaroff, Leonid V., And Buerger, Martin J. - The Powder Method In X-Ray Crystallography, McGraw-Hill Book Company, Inc., New York, 1958.

Jeffery, J.W. - Methods In X-Ray Crystallography, Academic Press, London And New York, 1971.

Klug, H. P., And Alexander, L E. - X-Ray Diffraction Procedures For Polycrystalline And Amorphous Materials (2nd Ed), John Wiley And Sons, New York, 1974.

Lipson, H., And Steeple, H. - Interpretation Of X-Ray Powder Diffraction Patterns, St. Martin's Press, New York, 1970.

Stout, George H., And Jensen, Lyle H. - X-Ray Structure Determination, The Macmillan Company, New York, 1968.

Powder Diffraction File, International Center for Diffraction Data, 1601 Park Lane, Swarthmore, PA, 19081.

It is unlawful to make radiographs of stamps of the United States of America or other countries without specific authorization from the Chief of the U.S. Secret Service, Washington, D.C. This permission has been received.